

ODILE Collection
Design Paolo Cappello

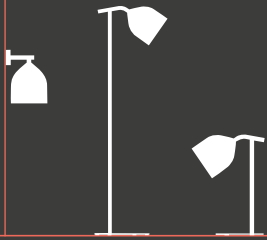

OUTLINE
Design Francesco Murano



Special edition
CONCORDE
Design VillaTosca



Configuratore
BRICK, BRAC, DOMINO
Design VillaTosca

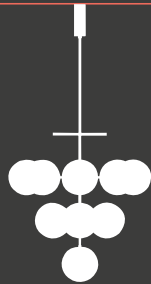
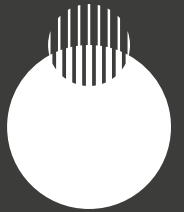

PLANETS
Design JAMO Associated

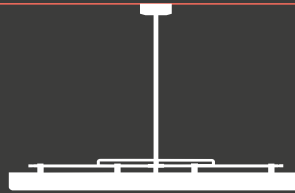

LUXOLINE
Design Line Inc.

LUMEN CENTER ITALIA

THE EXCELLENCE OF LIGHTING DESIGN SINCE 1976

LUMEN CENTER ITALIA amplia la gamma di prodotti con lampade più belle e adatte alla nuova sensibilità della clientela.

LUMEN CENTER ITALIA enhances the range of products with more beautiful lamps, suitable for the new sensitivity of the customer base.

ODILE, lampada di grande successo commerciale, si arricchisce delle versioni applique, tavolo e terra, mentre fa il suo ingresso OUTLINE lampada da parete di Francesco Murano.

ODILE, a commercial successful lamp, is now enriched by the wall light, table and floor versions, while the wall lamp OUTLINE by Francesco Murano makes its entrance.

Sul sito LUMEN CENTER ITALIA architetti e interior designer potranno personalizzare i loro ambienti con il "configuratore" disponibile per i modelli DOMINO, BRICK e BRAC: si potranno scegliere colori, finiture, lenti, gradi Kelvin dei Led. La scelta si completa con la possibilità di inserire speciali diffusori sonori.

On LUMEN CENTER ITALIA website, architects and interiors designers will be able to personalize their settings through the "configurator", available for DOMINO, BRICK and BRAC: it will be possible to choose colours, finishes, lenses and Kelvin degrees of LED. The choice can then be completed by the addition of a special sound loudspeaker.

Nel segmento luxury, PLANETS e LUXOLINE, disegnate rispettivamente dai Giapponesi Jamo e Line, completano la gamma proposta per EuroLuce 2017.

PLANETS and LUXOLINE, designed by the Japanese Jamo and Line, complete the array put forward for the luxury category for the EuroLuce Exhibition 2017.

Tante novità che dimostrano con evidenza la professionalità, la competenza, la passione e la volontà di LUMEN CENTER ITALIA di continuare a servire sempre meglio la propria clientela.

This innovation clearly highlights the professionalism, competence, passion and the willpower of LUMEN CENTER ITALIA to continuously improve the service for its clients.



PLANETS

Design JAMO Associated

SOSPENSIONE / SUSPENSION

La perfezione sferica come archetipo simbolico dei pianeti. PLANETS si ispira ed ispira il loro fascino e la loro sempiterna capacità attrattiva.

The spherical perfection as symbolic archetype of the planets. PLANETS is inspired and inspires their outstanding attractiveness and their everlasting allure.

INFO

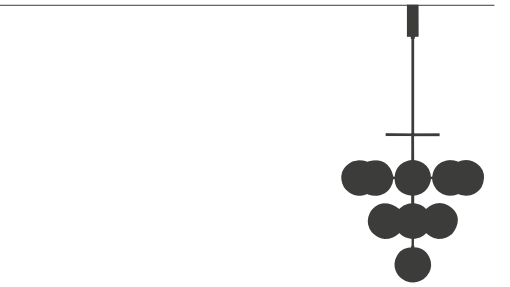
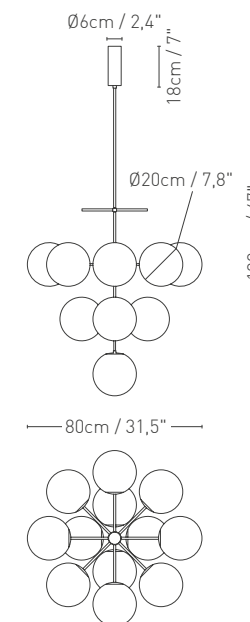

MATERIAL: Metal
FINISHES: 176 Bronzed brass
DIFFUSER: Polyethylene glossy white
SUGGESTED LIGHT SOURCE:
110/120V - 220/240V
Halogen ECO Socket E14 max 13x30W
5265lm 2700k
LED Socket E14 max 13x15w
ENERGY LABEL: A+ / A / B / C / D
CE Classe I IP20

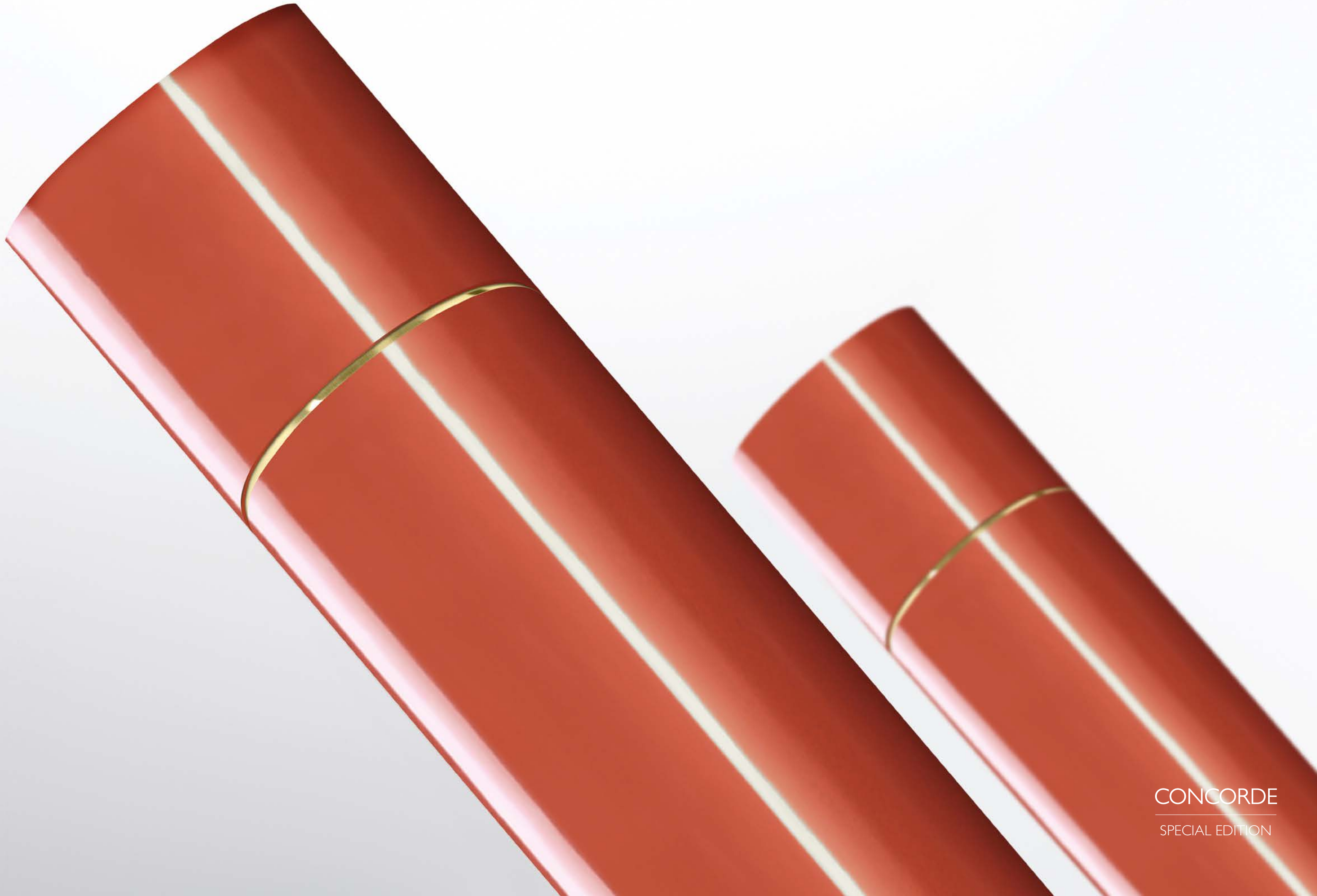

CONCORDE SPECIAL EDITION

Design VILLATOSCA

TERRA / FLOOR

Un cilindro monolitico colorato di un rosso speciale. Discreta nelle forme, CONCORDE special edition, si fa notare per il suo colore e per le sue prestazioni eccezionali. Le finiture aggraziate sottolineano l'eleganza e la raffinatezza dell'oggetto.

A monolithic cylinder, coloured with a distinctive red. Despite its delicate forms, CONCORDE special edition captures the attention for its colour and its exceptional performance. Its graceful finishes underline the elegance and refinement of this object.



INFO

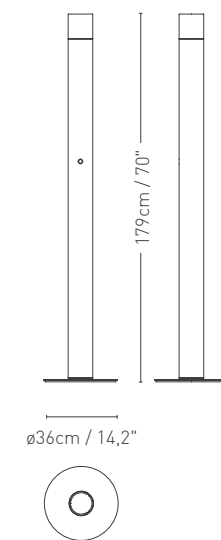

MATERIAL: Metal
FINISHES:
 128 Red Montenapo + 152 Satin brass
DIFFUSER:
 PMMA methacrylate diffuser
ELECTRONIC DRIVER:
 Dimmable included
LIGHT SOURCE: LED 50W
 110/120V - 220/240V
 4800lm 2700K CRI>90
ENERGY LABEL: A+ / A
 CE ENEC IP20





LUXOLINE

Design LINE INC.

SOSPENSIONE / SUSPENSION

All'apparente semplicità della linea, LUXOLINE associa la ricercatezza delle lavorazioni metalliche e delle finiture. La versione con finitura in pelle esprime al meglio il magnifico connubio tra l'estetica, le forme e la funzione.

LUXOLINE combines the conspicuous care of its metal manufactures and its finishes to the apparent simplicity of its lines. The leather trim version best expresses the perfect match of beauty, forms and function.

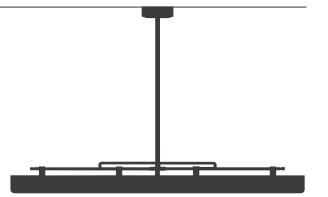

INFO

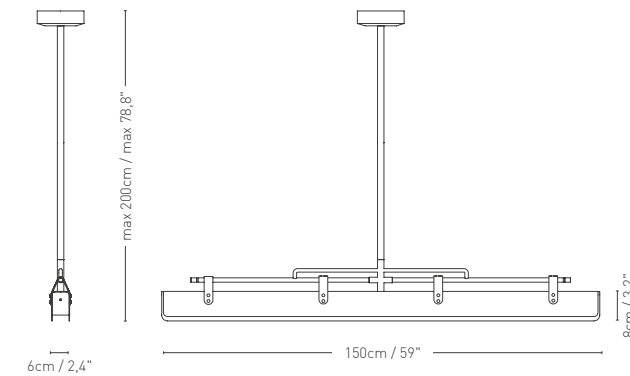

MATERIAL: Metal + Leather
FINISHES:
CN Natural Leather + 152 Satin brass
CB Black Leather + 166 Satin Nickel
DIFFUSER: PMMA methacrylate diffuser
ELECTRONIC DRIVER:
Dimmable included TRIAC
LIGHT SOURCE: LED 1x30W
110/120V - 220/240V
3900lm 3000K CRI>90
ENERGY LABEL: A
CE  Classe I IP20

Mod. LUXOLINE Suspension





Mod. ODILE Floor Wall Table

ODILE COLLECTION

Design PAOLO CAPPELLO

TERRA, TAVOLO, PARETE / FLOOR, TABLE, WALL

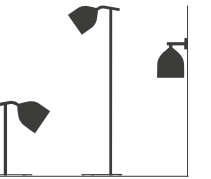

La semplicità della forma e della funzione si fondono in un prodotto con una presenza iconica e a tratti ironica: una lampada che non solo illumina, ma lo fa con una forte identità di carattere che la rende protagonista degli ambienti.

The simplicity of its form and function are combined in a product with an iconic presence and sometimes ironic: a lamp that doesn't only light up, but rather becomes the protagonist of the room thanks to its strong character identity.



INFO

ODILE TERRA
Floor lamp



ODILE PARETE
Wall lamp

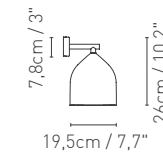

ODILE LETTURA
Table lamp

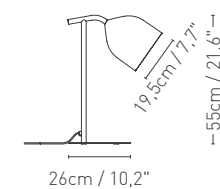

MATERIAL: Metal
FINISHES: Epoxy powders
 105FT White / 125FT Anthracite grey /
 126FT Sage green / 127 FT Senape
SUGGESTED LIGHT SOURCE:
 110/120V 220/240V
 HALOGEN ECO Socket E27max 1x55W
 ECO Fluo Globe ø 100mm Socket E27
 1x24W max / **LED** Socket E14
ENERGY LABEL: A+ / A / B / C / D
 CE ENEC F PS IP20
ODILE PARETE: Classe I

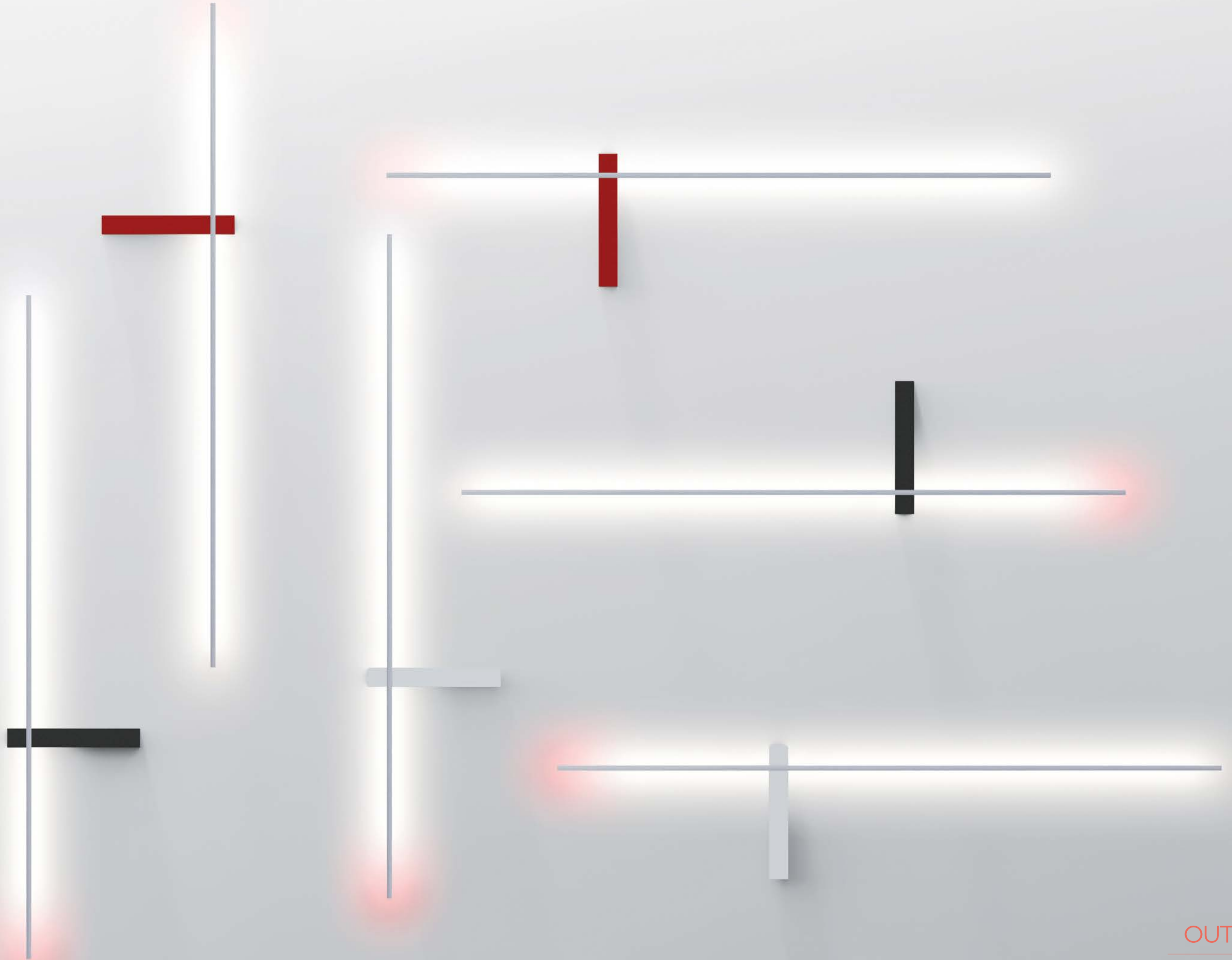

OUTLINE

Design FRANCESCO MURANO

PARETE / WALL

L'apparecchio luminoso è concepito come elemento compositivo della luce policroma proiettata sul muro.

La lampada e la luce diventano affresco lumistico nello spazio, segno grafico di forte impatto visivo, capace di caratterizzare la parete e l'ambiente.

*The light device was created as composition element of the polychrome light projected onto the wall.
Lamp and light become a fresco in the space, graphic signal for a strong visual impact, able to characterize wall and setting itself.*



INFO

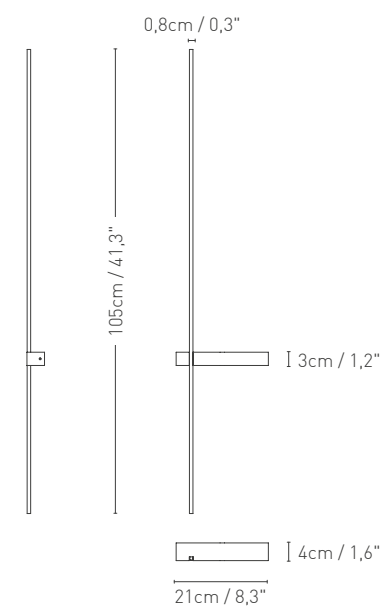

MATERIAL: Metal
FINISHES:
 172 Natural anodized + 103FT Black
 172 Natural anodized + 105FT White
 172 Natural anodized + 129FT Red
ELECTRONIC DRIVER: included: ON-OFF
LIGHT SOURCE: LED 1x12W
 50/60 Hz 110/120V - 220/240V
 1560lm 3000K CRI>90
 LED 1x1W Red
ENERGY LABEL: A
 CE Classe I IP20



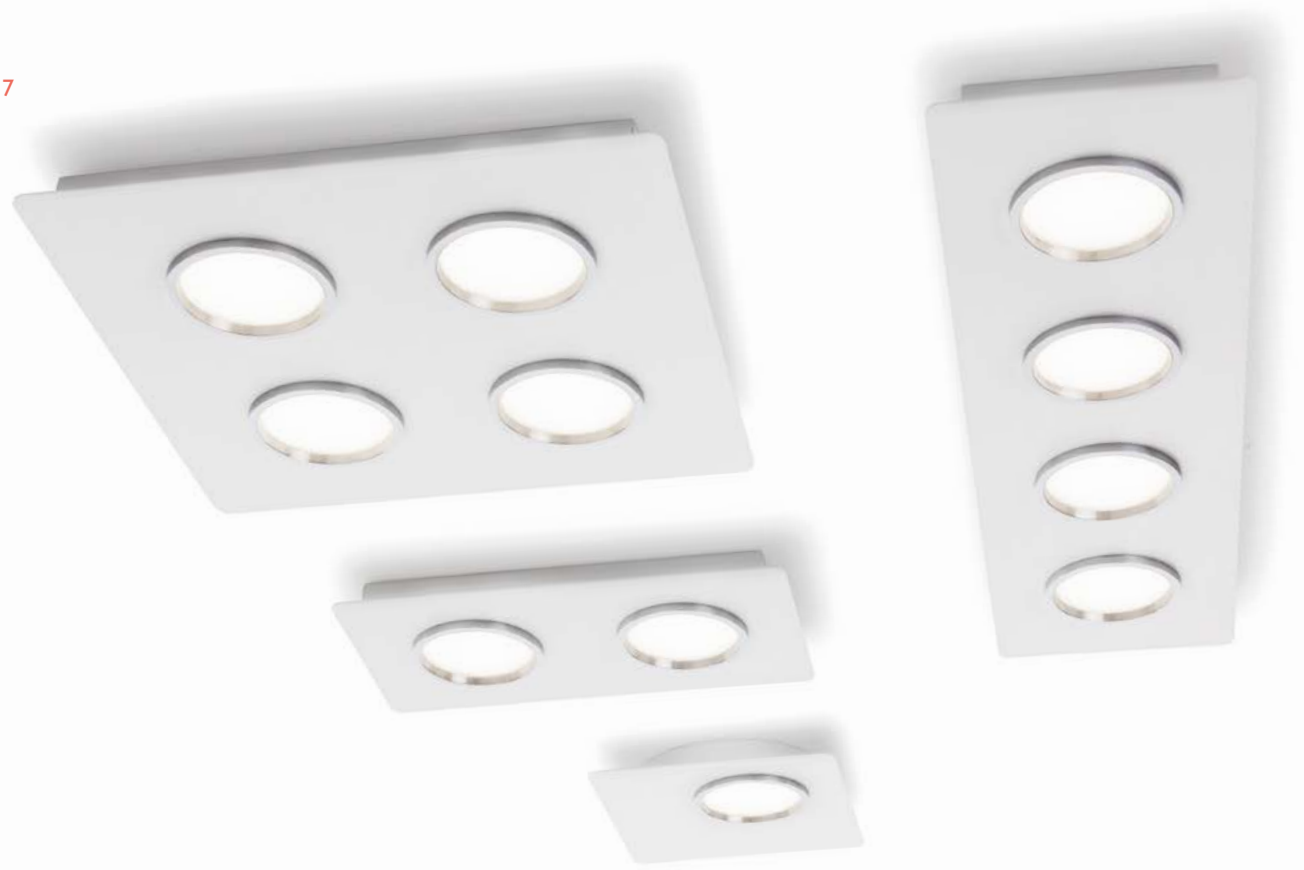

BRICK / BRAC / DOMINO

Design VILLATOSCA

SOFFITTO / CEILING

BRICK, BRAC e DOMINO sono le plafoniere disegnate da VillaTosca dal design essenziale e accattivante.

Forme elementari come cerchi, quadrati, rettangoli ed esagoni irregolari da usare singolarmente o in multiplo per creare composizioni personali e di sicuro effetto.

BRICK, BRAC and DOMINO are the ceiling lights designed by VillaTosca, with an essential and charming design. Elementary shapes like irregular circles, squares, rectangles and hexagons to be used singularly or in multiple way to create personal compositions of certain effect.



INFO

BRICK

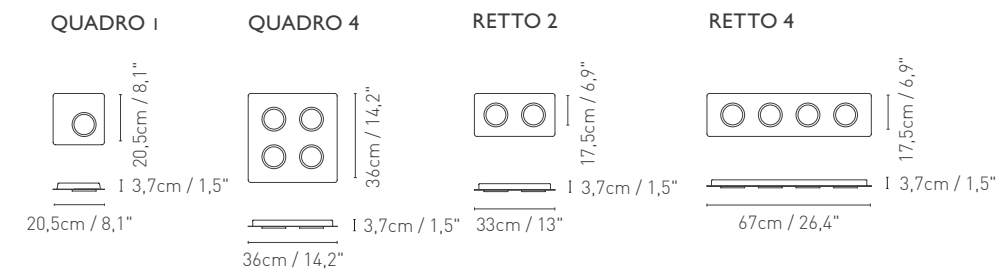

BRAC

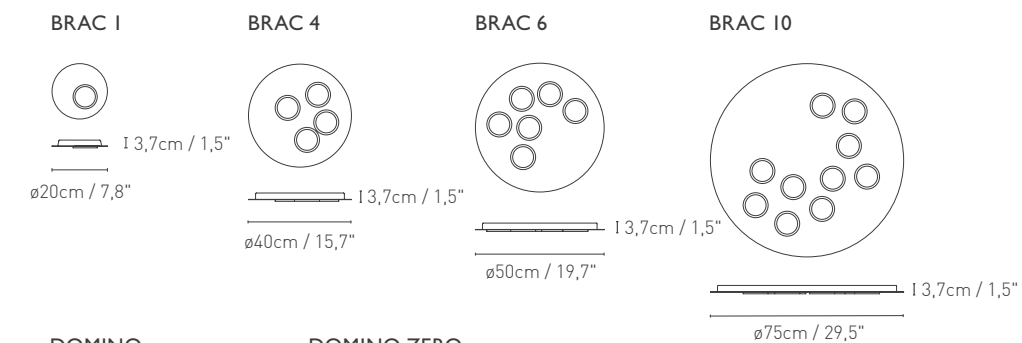

DOMINO

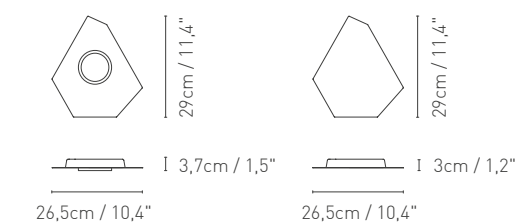

MATERIAL: Metal
FINISHES: Epoxy powders, Gold foil, Silver foil
RING: Chrome, Satin brass, Epoxy powder
DIFFUSER: PMMA methacrylate diffuser
ELECTRONIC DRIVER: Dimmable included TRIAC
LIGHT SOURCE: LED
 110/120V - 220/240V
 2700K - 3000K - 4000K CRI>90
BRICK QUADRO 1 1x5,8W 690lm
BRICK QUADRO 4 4x5,8W 2760lm
BRICK RETTO 2 2x5,8W 1380lm
BRICK RETTO 4 4x5,8W 2760lm
BRAC 1 1x5,8W 690lm
BRAC 4 4x5,8W 2760lm
BRAC 6 6x5,8W 4140lm
BRAC 10 10x5,8W 6950lm
DOMINO 1x5,8W 690lm
ENERGY LABEL: A+ / A
 CE ENEC Classe I IP20

FORMA Shape	FINITURA BASE Basic finishing	FINITURA SUPERFICIE Cover finishing	FINITURA ANELLI Rings finishing	OTTICA Optique	TEMPERATURA COLORE Colour Temperature	ALIMENTATORE Driver	ACCESSORIO Optional
BRICK QUADRO 1 	W  WHITE	W  WHITE	W  WHITE	 WIDE	<input checked="" type="checkbox"/>  2700K	220/240V	 SPEAKER
<input checked="" type="checkbox"/> BRICK QUADRO 4 	T  TITANIUM	T  TITANIUM	T  TITANIUM	<input checked="" type="checkbox"/>  MEDIUM	 3000K	<input checked="" type="checkbox"/> 110/120V	
BRICK RETTO 2 							
BRICK RETTO 4 							
BRAC 1 	G  SAGE GREEN	G  SAGE GREEN	G  SAGE GREEN	 HONEY COMB	 4000K		
BRAC 4 	S  SAND GREY	S  SAND GREY	<input checked="" type="checkbox"/> S  SAND GREY				
BRAC 6 			N  COR-TEN				
BRAC 10 	<input checked="" type="checkbox"/> N  COR-TEN	<input checked="" type="checkbox"/> N  COR-TEN	H  CHARTREUSE GREEN				
DOMINO 		O  GOLD FOIL	R  RED				
DOMINO ZERO 		A  SILVER FOIL	C  CHROME				
			B  SATIN BRASS				

SHAPE: BRICK QUADRO 4
 BASIC FINISHING: N COR-TEN
 COVER FINISHING: N COR-TEN
 RING: S SAND GREY
 OPTIQUE: MEDIUM
 COLOUR TEMPERATURE: 2700K
 DRIVER: 110/120V
 OPTIONAL: NO



DOMINO

Design VILLATOSCA

COVER: A SILVER FOIL
RING: T TITANIUM

COVER: W WHITE
RING: W WHITE

COVER: S SAND GREY
RING: B SATIN BRASS

COVER: G SAGE GREEN
RING: W WHITE

COVER: G SAGE GREEN
RING: G SAGE GREEN

COVER: W WHITE
RING: S SAND GREY

COVER: S SAND GREY
RING: S SAND GREY

COVER: G SAGE GREEN
RING: H CHARTREUSE GREEN

COVER: N COR-TEN
RING: G SAGE GREEN

COVER: G GOLD FOIL
RING: N COR-TEN

COVER: T TITANIUM
RING: C CHROME

COVER: W WHITE
RING: R RED

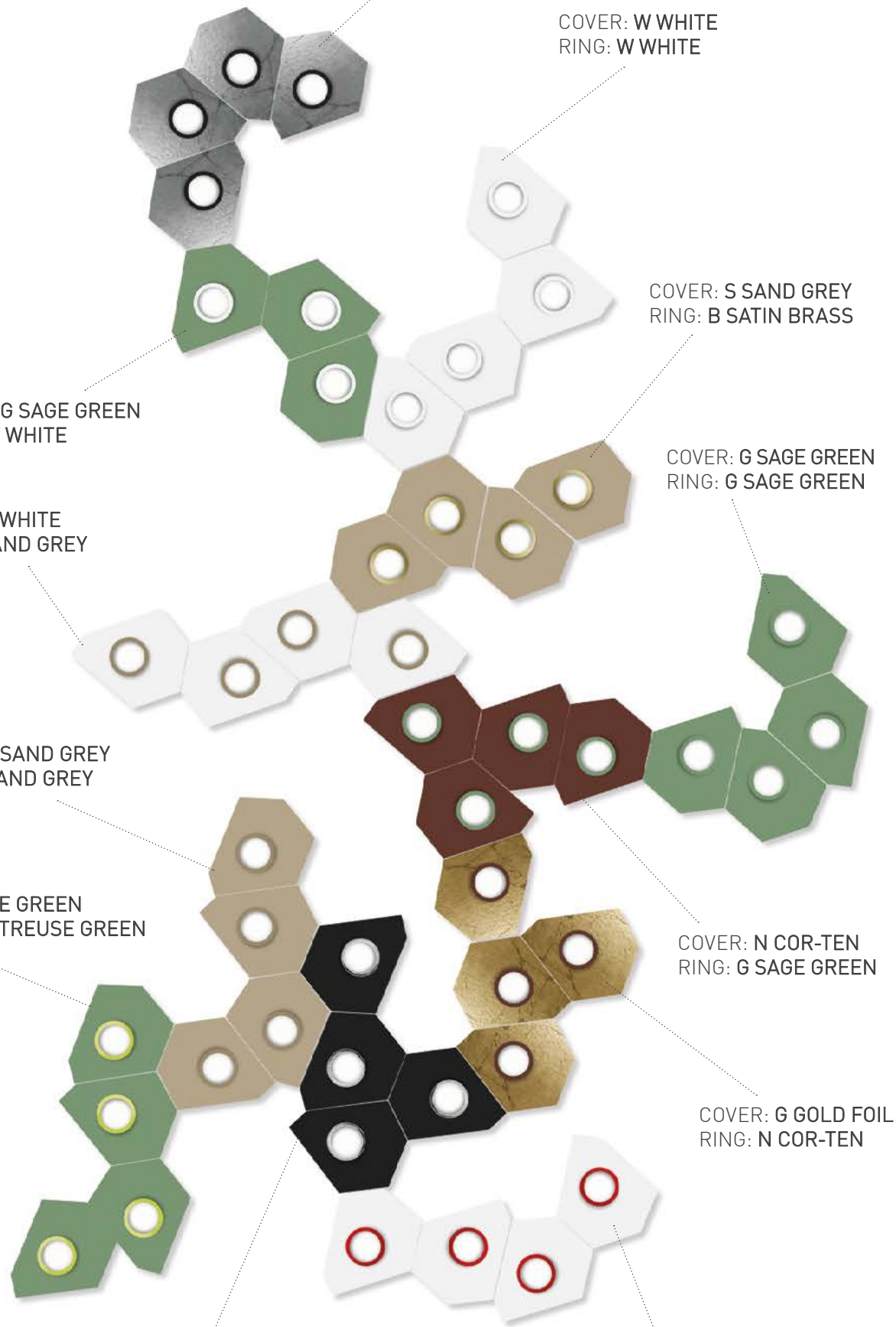



LUMEN CENTER ITALIA Srl

Via Donatori del Sangue n.37
20010 Santo Stefano Ticino (MI) Italia
tel. +39 02 3654 4811
info@lumencenteritalia.com

ITALY OFFICE

tel. +39 02 3654 4311
italysales@lumencenteritalia.com

EXPORT OFFICE

tel. +39 02 3654 4308
exportsales@lumencenteritalia.com

MADE IN ITALY



LCI
ITALIA

LCI
JAPAN

lumencenteritalia.com
LIGHT CREATIVITY INNOVATION