

**LUMEN
CENTER
ITALIA**

40
YEARS
OF LIGHT
1976 - 2016

MADE IN ITALY



LUMEN CENTER ITALIA Srl
Via Donatori del Sangue n.37
20010 Santo Stefano Ticino (MI) Italia
tel. +39 02 3654 4811
info@lumencenteritalia.com

ITALY OFFICE
tel. +39 02 3654 4311
italysales@lumencenteritalia.com

EXPORT OFFICE
tel. +39 02 3654 4308
exportsales@lumencenteritalia.com



LIGHTING SPONSOR



LUMEN CENTER ITALIA

THE EXCELLENCE OF LIGHTING DESIGN SINCE 1976



LUMEN CENTER ITALIA (LCI) festeggia i suoi primi 40 anni di attività e arricchisce la propria collezione con nuove lampade in linea con le più sofisticate richieste ed esigenze della clientela.

Quattro nuove plafoniere, due sospensioni e tre lampade da terra coniugano l'esigenza del risparmio energetico con la massima attenzione alla qualità estetica ed alla qualità della luce.

L'offerta si amplia con la trasformazione a LED di sette Classici LCI. I clienti storici potranno così godere di una riedizione come Omega e delle nuove versioni LED delle conosciutissime: Torchère, Trylon, 555, 570, Blum, MCP e Victory.

Dal 1976 LUMEN CENTER ITALIA è un grande laboratorio di ricerca, design e produzione di apparecchi per l'illuminazione.

La sua vocazione per il design contemporaneo ed il suo orientamento verso i mercati internazionali hanno origini lontane: l'azienda nasce, infatti, come LUMEN CENTER FRANCE a La Fare-les-Oliviers, con la collezione di lampade di importanti designer francesi, diviene LUMEN CENTER ITALIA, rafforza il proprio *core business*, cresce e si espande fino all'estremo Oriente con la nuova nata LUMEN CENTER JAPAN.

Da sempre attenta alla qualità, LCI è un luogo dove si indaga la relazione fra l'uomo e la luce, dove si sperimentano tecnologie che attraverso un utilizzo innovativo delle fonti luminose possano migliorare la qualità della vita e accompagnare nel modo più confortevole i diversi momenti della quotidianità, dal relax al lavoro, dalla fruizione culturale al convivio e al cibo.

Tra gli ultimi importanti progetti di ricerca, il progetto **luum®**, che offre sorgenti luminose LED attente all'interazione tra luce e metabolismo cellulare, con un'altissima resa cromatica e con uno spettro molto simile a quello della luce naturale.

Sono queste le sorgenti che LUMEN CENTER ITALIA ha scelto per illuminare la *food court* del padiglione Giappone ad Expo 2015 e la Veneranda Pinacoteca Ambrosiana di Milano, dove una luce di qualità LED esalta i dettagli e le cromie del cibo così come le opere di Leonardo Da Vinci, Tiziano, Raffaello, Bruegel e Botticelli.

LUMEN CENTER ITALIA (LCI) is celebrating its first 40 years in business and enriches its collection with new lamps in line with the most sophisticated demands and customer needs.

Four new light fixtures, two suspensions and three floor lamps combine the need for energy savings with the utmost attention to the aesthetic quality and the quality of light.

The offer is extended with the transformation in LED version of seven lamps of the LCI Classic collection. Historical Customers will enjoy a new edition of Omega and the new LED versions of the very well known: Torchère, Trylon, 555, 570, Blum, MCP and Victory.

Since 1976 LUMEN CENTER ITALIA is a big laboratory of research, design and production of light fittings. Its vocation for contemporary design and its international markets orientations has faraway origins: the company was born as LUMEN CENTER FRANCE in La Fare-les-Oliviers, with an important lighting collection of French designers. It becomes later LUMEN CENTER ITALIA strengthening its core business, growing and pushing itself up to the Far East with the newborn LUMEN CENTER JAPAN.

Always dedicated to quality, LUMEN CENTER ITALIA is a place where connections between man and light are studied, a place where new technologies are tested through an innovative use of light sources which improve quality of life and accompany different moments, from relaxing to work, from cultural enjoyment to food.

*In the latest research projects stands out **luum®**, which offers LED light sources attentive to the interactions between metabolism and light, with a very high color rendering and a light source spectrum comparable to daylight.*

*LUMEN CENTER ITALIA has chosen **luum®** to light up Japan Pavilion food court at Expo 2015 and Veneranda Biblioteca Ambrosiana of Milan, where high-quality LED enhances details, warm colors and shades of food as well as Leonardo Da Vinci, Tiziano, Raffaello, Bruegel and Botticelli masterpieces.*

ルーメンセンターイタリア (LCI) はこのたびの40周年を記念した新たなコレクションを発表致しました。それは、洗練はもちろんの事、お客様のニーズにもお答えできる商品群です。

4つの新しいシーリングランプ、2つのペンダントランプ、3つのフロアーランプ、そのどれもがデザインだけでなく省エネルギーと光の質そのものにもこだわりを持って開発を行いました。

また、LCIの歴史を作ってきた重要なクラシック・コレクションもリニューアルを致しました。

TORCHERE (トルシェ), TRYLON (トリロン), 555, 570, BLUM (ブルム), MCP, VICTORY (ビクトリー) をLED化。そして“OMEGA (オメガ)” もLED化によって復活させました。

ルーメンセンター・イタリアは、1976年より照明機器の研究、デザイン、製造を一貫して行っている工房です。時流に沿ったデザインと国際市場に対する姿勢は、指標として創立当初より受け継がれております。その誕生はルーメンセンター・フランスとしてラファール・レゾリヴィエール (フランス) に設立され、その当時から著名なフランス人デザイナーによる照明コレクションが数々と生み出されて来ました。その後、ルーメンセンター・イタリアとなり、そのコア・ビジネスを強化し、成長、拡大を続けることで新たにルーメンセンター・ジャパンの開設するまでに至りました。

ルーメンセンター・イタリアは、常日頃からその「品質」に重きを置きつつ、「人」と「光」の関係を研究し、革新的な光源のテクノロジーの追及も行っています。これによって、人々の生活向上と日常の様々な状況 (リラックス、仕事、趣味行為、団らん、食事など) に適した『あかり』をお届けすることを目指しております。

数々の研究プロジェクトの中でも最も重要なものに「**luum®**」計画があげられます。

これは、光と人間の代謝の相互作用を考慮し、色彩再現力が非常に高く、光のスペクトルが自然光に最も近いLED光源を採用しています。

ルーメンセンター・イタリアは、ミラノ国際万博2015の日本館のフードコートと歴史あるアンブロジーナ絵画館のためにこのLED光源を導入しました。

これによって、食の空間から、レオナルド・ダヴィンチ、ティツィアーノ、ラファエロ、ブルーゲルやボッティチェリ達の作品といった芸術の世界まで、そのディテールと色彩の再現を可能と致しました。

LUMEN CENTER ITALIA

LIGHT, CREATIVITY, INNOVATION

Nasce nel 1976 a La-Fare-les-Oliviers in Francia sotto la direzione artistica di Gilles Derain, esponente di rilievo del design contemporaneo francese e tra i primi estimatori e studiosi dell'UAM - Union des Artistes Modernes - un movimento attivo tra il 1928 e il 1958, che confluì poi nel movimento moderno internazionale, e che vide tra i suoi fondatori artisti di spicco quali Eileen Gray, Charlotte Perriand, Jacques Adnet - di cui viene prodotta la lampada Quadro del 1929 - e Pierre Chareau, a cui viene dedicata la lampada MCP (Merci Chareau Pierre) che nel 1979 ebbe un grandissimo successo commerciale ed entrò a far parte della Collezione permanente del Museo di Belle Arti di Montreal.

Da sempre prodotti in Italia da una delle aziende di illuminazione del distretto milanese, i pezzi a catalogo, dell'allora francese Lumen Center, venivano commercializzati su territorio nazionale da LUMEN CENTER ITALIA, società italiana che qualche anno dopo rileva la società francese e diventa unica proprietaria e distributrice

sia a livello nazionale che internazionale. La consolidata collaborazione con i designer francesi tra cui Jean-Michel Wilmotte, autore della celebre lampada da tavolo Washington, e la ormai nota qualità dei prodotti offerti fanno sì che l'azienda, seppur di dimensioni ridotte e a conduzione familiare, acquisti sempre più quote di mercato consolidando la propria posizione nel panorama italiano ed internazionale dell'illuminazione.

È a fine anni Novanta che si prospetta una grande svolta, quando il DMC VillaTosca - coordinato e diretto da Augusto Grillo - entra in contatto con LUMEN CENTER ITALIA per la realizzazione del progetto di interior design e illuminazione del Royal Pines Hotel di Urawa in Giappone. Il progetto fu chiamato "Life River" e ancora oggi rappresenta l'altissima capacità tecnico-produttiva dell'azienda, nonché la capacità di realizzare con grande flessibilità progetti "tailor-made". L'avventura del DMC VillaTosca nel settore dell'illuminazione era però iniziata già nel 1993 in seguito ad un

programma di ricerca volto ad esplorare la luce colorata che confluì poi in un workshop sperimentale che si svolse nel suggestivo convento di Greccio e vide coinvolti numerosi studiosi e progettisti. Furono proprio i due progetti "Life River" ed "Heliopolis" che nel 2000 portarono il Gruppo VillaTosca ad acquisire LUMEN CENTER ITALIA.

Da allora, sono innumerevoli le iniziative portate avanti dall'azienda a livello internazionale; all'avanguardia le sperimentazioni sulle sinestesie tra luce, colore e suono, sull'utilizzo di sorgenti alternative come gli OLED o gli studi sull'interazione tra luce e metabolismo umano con l'avvio del progetto **luum**. Oggi LUMEN CENTER ITALIA vanta una filiale a Tokyo in Giappone con l'obiettivo di consolidare la sua presenza nei mercati dell'estremo Oriente, è stata sponsor dell'illuminazione della *food court* del Padiglione Giappone ad Expo 2015 e illumina le importanti opere di Leonardo Da Vinci, Tiziano, Raffaello, Bruegel e Botticelli presso la Veneranda Pinacoteca Ambrosiana di Milano.

Grounded in 1976 in La-Fare-les-Oliviers in France under the artistic direction of Gilles Derain, prominent exponent of the French contemporary design and one of the first admirers and researchers of UAM - Union des Artistes Modernes. This movement was active between 1928 and 1958, afterward it merged into the International Modern Movement and had among its founders prominent artists such as Eileen Gray, Charlotte Perriand, Jacques Adnet - whose table lamp Quadro designed in 1929 was produced by LCI - and Pierre Chareau to whom the lamp MCP was dedicated (Merci Pierre Chareau) which in 1979 had a huge commercial success and became part of the permanent collection of the Museum of Fine Arts in Montreal.

Since the beginning the lamps of the French Lumen Center catalogue have always been produced in Italy by a lighting manufacturer in the district of Milan and distributed on the national market by LUMEN CENTER ITALIA, an Italian company that a few years later took over the French company. It became

the sole owner and distributed the lamps on both the national and international markets. Thanks to the strict collaboration with French designers including Jean-Michel Wilmotte, designer of the famous table lamp Washington, and the long well known quality of the offered products, this company, albeit not big and family-run, has been gaining more and more market share consolidating its position in the Italian and international lighting sector.

In the late nineties a great turning point was close at hand, when the DMC Villa Tosca Design Management Centre - coordinated and directed by Augusto Grillo - came into contact with LUMEN CENTER ITALIA for the realization of the project of the interiors and lighting design of Urawa Royal Pines Hotel in Japan. The project was called "Life River" and still represents the company's very high technical-productive know-how and skill, as well as the ability to manage with great flexibility "tailor-made" projects. The adventure of DMC VillaTosca in the lighting industry, however, had its start in 1993 as

a result of a research program aimed at exploring the coloured light which then merged into an experimental workshop that took place in the striking convent of Greccio and saw many scholars, researchers and designers involved. It was these two projects "Life River" and "Heliopolis", that in 2000 led the Group VillaTosca to acquire LUMEN CENTER ITALIA.

*Since then, the company has made numerous innovations from being groundbreaking with studies on synesthesia (relations between light, color and sound), to the use of alternative light sources as OLED or researches on the interactions between light and human metabolism with **luum** project. Nowadays LUMEN CENTER ITALIA claims another company in Tokyo (Japan) to consolidate its presence in Far East markets; indeed it has been technical sponsor of Japan Pavilion food court at Expo2015 and also lights up Leonardo Da Vinci, Tiziano, Raffaello, Bruegel and Botticelli masterpieces at Veneranda Pinacoteca Ambrosiana of Milan.*

1976年、フランスのラファール・レゾリヴィエールにルーメンセンターが創設されました。その創設はUAM*の最初の代表的な研究者でもあり、近代フランスデザイン界を象徴する人物でもあるジル・デレンがアートディレクションを担いました。
*UAM (Union des artistes modernes) は1928年から1958年まで活動し、国際的な近代芸術運動にまで発展しました。アイリーン・グレイ、シャルロット・ペリアン、ジャック・アドゥネが創設メンバーとしてその名を連ねています。ジャック・アドゥネは1929年に「クアドロ」をデザインしました。また、ピエール・シャローのためにはMCP (ピエール・シャローの追憶) が1979年に製品化されています。これは、商業的にも大成功を収め、モントリオール美術館に常設展示されています。

当時からフランスのルーメンセンターは、ミラノ工業地区の照明メーカーに製品の製造からカタログの作成まで依頼をしていました。その機関をルーメンセンター・イタリアと呼び、イタリア国内において商業展開も行っていました。その後、イタリアのメーカーがこの本家フランスのブランドを買収、これによって、国内外全てにおいて唯一のオーナーとしてその販売を行うこととなりました。その後もジャン＝ミッシェル・ウィルモット (テーブルランプ「フシントン」のデザイナー) をはじめとするフ

ランス人デザイナーたちとの密接なコラボレーションは行われました。家族経営と経営規模の縮小がおこなわれたにもかかわらず、この当時から、製品の品質が高いメーカーとして注目されており、イタリア国内をはじめ国際的な舞台においてその地盤を固めていきました。

90年代後半には大きなターニングポイントを迎えます。それは当時、DMCヴィットラスカ (アウグスト・グリッコ代表) が、日本の浦和バインズホテルのインテリアおよび照明デザイン計画のためルーメンセンター・イタリアと接触したことに始まります。「ライフリバー」と呼ばれた「テイラーメイド (特注)」デザインプロジェクトの中で、培われた生産技術は絶大な柔軟性を発揮し、今日にいたってもこのメーカーの最高水準の粋意を尽くしたものの代表的な作品となっています。DMCヴィットラスカは、既に1993年よりカラーライトの照明開発に着手しています。このプログラムは、魅力溢れるイタリアーグレッッチョ修道院にて数多くの専門家、研究者やデザイナーが参加した実験的なワークショップへと発展しました。この「ライフリバー」と「ヘリオポリス」の二つのプロジェクトが、2000年にヴィットラスカグループによってルーメンセンター・イタリアを買収するきっかけとなりました。これを境に、数多くの取り組みが国際的にも有数のレベルへと成長しました。

これを機に、前衛的で実験的な取り組みにおいても国際的な規模で数々のインシアチブを取っています。その例として「光」と「色」と「音」を同期させることによって行われる「シネステジア」、有機ELの照明用光源としての使用、光と人間の代謝の相互関係の研究結果としての最新LED光源の開発プロジェクト「ルーム / **luum**」などが挙げられます。

今日、ルーメンセンター・イタリアは極東市場における重要性を考慮し、日本の東京にLCIジャパンを開設しました。国際万博・Expo 2015 (イタリア・ミラノで開催) の日本館内部のフードコートの照明をスポンサーとして提供しました。さらに歴史あるアンブロジーアーナ絵画館 (イタリア・ミラノ・ヴァチカン市国所有) に収蔵されているレオナルド・ダヴィンチ、ティツィアーノ、ラファエロ、ブルーゲルやボッティチエッリ達の作品の照明機器を提供しています。

VILLATOSCA

DESIGN MANAGEMENT CENTRE

LUMEN CENTER ITALIA è parte del VillaTosca Design Management Centre - un'azienda specializzata nella gestione dei processi creativi - che, negli ultimi vent'anni, ha sviluppato metodologie innovative applicabili alle diverse fasi della progettazione: dalla ricerca tendenze, al concept di prodotti e servizi. L'anima del gruppo è il suo fondatore: Augusto Grillo - imprenditore, manager e sociologo dal percorso originale, contraddistinto dal profondo rapporto che lo lega con il Giappone, paese in cui ha studiato. Dal 2000, come proprietario e presidente di LUMEN CENTER ITALIA, ha guidato l'azienda in una direzione più internazionale ma l'ha anche trasformata in una azienda "design thinking" in cui Scienza e Umanesimo, Oriente ed Occidente, Numeri ed Estetica coesistono.

LUMEN CENTER ITALIA is part of VillaTosca Design Management Centre Group - a company specialized in managing creativity processes. In the last twenty years the company has developed innovative methodologies for the various phases of design from research on trends to the studies of concepts for products and processes. The soul of the Company is its founder, Augusto Grillo: entrepreneur, manager and sociologist who has a unique background, marked by the deep relationship that ties him to Japan, where he studied. Since 2000, Augusto Grillo has served as the owner and president of LUMEN CENTER ITALIA leading the company to a more international scope but also guiding it into a "design thinking" company in which Humanism and Science, West and East, Numbers and Aesthetics coexist.

ルーメンセンター・イタリアは、クリエイティブ事業に特化した組織である VillaTosca Design Management Centre グループの一員としても活動を行っています。過去20年間にわたり、トレンドの動向調査から製品・工程コンセプトの研究に至るまで、さまざまなデザイン段階において画期的な手法を開発してきました。ルーメンセンター・イタリアの企業精神は、代表者アウグスト・グリッコによって築かれました。起業家、マネージャー、社会学者など多彩な側面を持つグリッコは、日本への留学経験もあり、日本と深いかわりがあります。グリッコは2000年からルーメンセンター・イタリアのオーナー兼社長として就任し、当社をさらに国際的な舞台に導くと同時に、ヒューマニズムと科学、西洋と東洋、数字と美が共存するデザイン志向の企業として成長させてきました。

DESIGNER



JACQUES ADNET

Jacques Adnet (1900-1984) architetto e designer, esponente di spicco del movimento Modernista francese. Dopo gli studi presso la Scuola di Design di Auxerre e presso L'Ecole des Arts Decoratifs, Adnet fondò la compagnia JJ Adnet insieme al fratello gemello Jean. Dal 1928 al 1960 fu direttore della Compagnie des Arts Français. Tra i designer del suo team ci furono personaggi di spicco quali Francois Jourdain, Charlotte Perriand e Georges Jouve. Durante gli anni '50, si dedicò alla progettazione di arredi e ricevette numerosi incarichi tra i quali la decorazione degli appartamenti privati del presidente francese all'Eliseo e la sala riunioni dei quartieri generali parigini dell'UNESCO. Dal 1959 al 1970 diresse l'École Nationale Supérieure des Arts Décoratifs di Parigi.

Jacques Adnet (1900-1984) was a French architect and Art Deco Modernist designer and an icon of French Modernism. After completing his studies at the Municipal School of Design in Auxerre and the Ecole des Arts Decoratifs, Adnet established the company, JJ Adnet with his twin brother Jean. From 1928 to 1960, he directed La Compagnie des Arts Français. His team of decorators included Francois Jourdain, Charlotte Perriand and Georges Jouve. During the 50s, he created furniture and concentrated on the numerous commissions he received, such as the decoration of the private apartments of the President at the Elysée Palace or the meeting room of the UNESCO headquarters in Paris. From 1959 till 1970 he has been director of the École nationale supérieure des arts décoratifs in Paris.

ジャック・アドゥネ (1900-1984) はフランス人建築家として近代アールデコのデザイナーでもありフランスモダニズムの象徴でもある。オクセル市立デザイン学校と工芸美術学校にて終業の後 J J アドゥネ社を双子の兄弟ジャンと共に設立。1928年から1960年までフランス芸術キャンペーンのディレクションを行った。彼のデコレーターチームにはフランソワ・ジュルデンやシャルロット・ベリアンやジョージ・ジューヴがいた。1950年代家具やコミッションの仕事数を多く手がけた。エリゼーバラスの会長自宅アパートやパリ市内のユネスコ本会議室などがその代表である。1959年から1970年、パリの工芸美術国立上級学校の校長を勤めた。



ENRICO AZZIMONTI
www.enricoazzimonti.it

Enrico Azzimonti, 1966, architetto e designer. Nel 1994 apre il suo studio di progettazione a Busto Arsizio, in una fabbrica iniziata '900 che si affaccia sull'ottocentesca strada napoleonica del Sempione che collegava Milano con Parigi. Ha collaborato con lo IUAV di Venezia e di San Marino, l'Università La Sapienza di Roma, l'Istituto Marangoni di Milano. Da alcuni anni svolge attività didattica presso lo IED di Milano. Ha progettato per aziende quali: LUMEN CENTER ITALIA, TVS, Lavazza, Fratelli Guzzini, Pavoni Italia, Coop, Jvc, Diamantini&Domeniconi, Risoli, Zava, BLM Group e altre. I suoi lavori si sono fatti notare in concorsi, mostre, esposizioni internazionali e sulla stampa specializzata in Italia ed all'estero. Alcuni suoi progetti fanno parte della collezione permanente del Museu de les Arts Decoratives di Barcellona.

Enrico Azzimonti, 1966, is an architect and designer. In 1994 he opened his design studio in Busto Arsizio in a factory, a twentieth century building, that faces the Napoleonic nineteenth century road that linked up Milan and Paris. He collaborated with the IUAV of Venezia and San Marino, the University La Sapienza of Rome, the Istituto Marangoni of Milan. He has been teaching since 2006 at IED, Istituto Europeo di Design of Milan. His works have been shown at international competitions and exhibitions, have been commented by press staff both in Italy and abroad. He has carried out some projects for: LUMEN CENTER ITALIA, TVS, Lavazza, Fratelli Guzzini, Coop, Jvc, Diamantini&Domeniconi, Risoli, Zava, BLM Group and others. Some of his works are shown at the permanent collection of the Museu de les Arts Décoratives in Barcelona.

エンリコ・アズィモンティ、1966年生まれ。1994年ブストアルスィツィオの十九世紀のミラノとパリを繋ぐナポレオン街道に面した二十世紀建築の工場に事務所を開設。彼は、ヴェネツィアとサンマリノの美術建築大学、ローマ・ラ・サピエンツァ大学、ミラノ・マランゴニ二専門学校とコラボレーションを行ってきた。国際コンクールや展示会にて数々の仕事を行い国内外のエディターから賞賛を集めた。ルーメンセンター・イタリアをはじめ、T V S、ラヴァッツァ、フラテッリ・グッツィーニ、コープ、J V C、ディアマンティーニ&ドメニコニ、リソリ、ザーヴァ、BLMグループなどと仕事をした経験がある。パルセロナ工芸美術博物館の永久コレクションに何点が収蔵されている。



BERNARD BROUSSE
www.bernardbrousse.com

Nato a Bordeaux in Francia nel 1948, è approdato al lighting design dopo aver lavorato a lungo nel settore nautico. Dal 2003 Bernard Brousse vive e lavora in Provenza. Da artigiano, produce la propria collezione di lampade e progetti di illuminazione per varie aziende europee. Nel 2004, ha ricevuto il "Compasso d'Oro" con il progetto Ellipsis. Il suo stile di ricerca è basato sui concetti di sobrietà, fluidità, leggerezza e funzionalità. Predilige l'uso di materiali quali legno, metallo, ceramiche, fogli di polipropilene, vetro e materiali compositi.

Born in Bordeaux (France) in 1948. He attains the lighting design after he worked for a long period in the nautical sector. Since 2003 Bernard Brousse lives and works in Provence. As a artisan, he designs his own collection of lamps and lighting projects for several European companies. In 2004, he received the "Compasso d'Oro" award with his project Ellipsis. His reaserach style is based upon sobriety, fluidity, lightness, and functionality concepts. He prefers the use of materials such as wood, metal, ceramics, polypropylene sheet, glass and composite materials.

ベルナール・ブルッセは、1948年フランス、ポルドーに生まれる。長年に亘って船舶関連の仕事を行った後、照明デザインにいたった。2003年よりフランス、プロバンスに在住し働いている。彼は、いわゆる工芸職人として数多くの照明デザイン、照明プロジェクトを数多くのメーカーのために行っている。2004年には、「コンパッソ・ドーロ (Compasso d'oro) 賞」を「エリプシス」のデザインで受賞している。彼のリサーチスタイルは品位、流動性、軽さ、そして機能性のコンセプトに基づいている。彼は、木、金属、セラミック、ポリプロピレンシートやガラスといった素材を好んで使用したデザインを行っている。



PAOLO CAPPELLO
www.paolocappello.com

Nasce nel 1980 a Verona. Si laurea presso il politecnico di Milano in disegno industriale. Dopo tre anni di collaborazione con Ludovica e Roberto Palomba a Milano, nel 2007 apre il suo studio a Verona dove collabora con altri professionisti in architettura, comunicazione e grafica. Dirige anche un dipartimento che sviluppa progetti d'interni di negozi per una delle più grandi aziende di abbigliamento italiane. Ha ricevuto molti premi a livello internazionale per i suoi lavori. I suoi lavori sono stati esposti presso molte mostre a Roma, Milano, New York, Parigi, São Paulo, Miami, Londra e Dubai. Paolo, inoltre, ha collaborato con la rivista Rolling Stone, scrivendo la colonna riguardante il design per l'edizione online del giornale. I lavori di Paolo sono stati presentati dalle maggiori testate giornalistiche e riviste: NY Times, Herald Tribune, Abitare, Interni, Ottagono, Residence, Dezeen, Icon, Elle Decor, Rolling Stone, Designboom etc.

Born in 1980 in Verona. Graduated in Industrial Design at Politecnico di Milano. After a three years collaboration with Ludovica and Roberto Palomba in Milan, in 2007 he setup his own studio in Verona where he collaborates with other professionals in architecture, communication and graphics, he's also heading a department that develops retail interiors projects for the biggest italian clothing brands. He received many international prizes for his works. His works have been showcased in many expositions in Rome, Milan, New York, Paris, São Paulo, Miami, London and Dubai. Paolo also collaborates with Rolling Stone magazine writing the design column for the online edition. Paolo's works have been featured by main international magazines and newspapers as NY Times, Herald Tribune, Abitare, Interni, Ottagono, Residence, Dezeen, Icon, Elle Decor, Rolling Stone, Designboom etc.

パオロ・カペッロ (Paolo Cappello) 1980年、ヴェローナ生まれ。ミラノ工科大学、工業デザイン学科卒業。卒業後は3年間、ミラノの『Ludovica+Roberto Palomba』事務所で働き、2007年にヴェローナ市で複数の専門家と共に建築、通信、グラフィックの分野で自分たちの事務所を開設しました。その後はイタリアで最大手のアパレルメーカーのインテリア開発を任せられるなどの活躍をし、数多くの国際的な賞を多数受賞しています。ヤングデザイナー・オブ・ザ・イヤー - ニューヨーク・トップ・ヤング・デザイナーズ、等。そして、彼の実現したプロジェクトは、ローマ、ミラノ、ニューヨーク、パリ、サンパウロ、マイアミ、ロンドン、ドバイ等の複数の国際都市見ることが出来ます。また、彼はRolling Stone誌の毎日オンライン版にデザインについての記事を掲載しています。その他、彼の仕事は各種メディアに取り上げられて居り、以下はその一部です。NY Times紙、Herald Tribune紙、Abitare誌、Interni誌、Ottagono誌、Residence誌、Dezeen誌、Icon誌、Elle Decor誌、Rolling Stone誌、Designboomサイト、等。



AMEDEO G. CAVALCHINI
www.studiocavalchini.com

Architetto, vive e lavora a Milano. La sua attività nasce da una lunga collaborazione con Paolo Rizzatto. Nel 1998 vince il premio Tiziana Mascheroni al concorso Young and Design. Nel 2000 apre il suo studio di Architettura e Design e realizza diversi interventi di ristrutturazione di interni con particolare propensione all'allestimento e al progetto illuminotecnico in Italia e all'estero. Da segnalare la progettazione e realizzazione dell'ingresso al Teatro della Luna di Assago e di tutto il masterplan attorno al Forum di Assago (Milano) per il Gruppo Cabassi. Specializzato in allestimenti e museografia, ha ricoperto per molti anni il ruolo di responsabile exhibition design per Luceplan, per cui ha anche disegnato diversi prodotti. Vincitore della Menzione d'Onore alla XXIII edizione del Compasso d'Oro 2014 nella categoria Exhibition Design con l'allestimento "Gino Sarfatti, il design della luce" alla Triennale di Milano. è docente di lighting design alla NABA e di design del prodotto allo IED di Milano.

Architect, lives and works in Milan. His activity started from a long collaboration with Paolo Rizzatto. In 1998 he won the Tiziana Mascheroni award in Young and Design contest. In 2000 he opened his Architecture and Design studio and realized several projects of interior renovation, paying attention particularly to out fitting and lighting in Italy and abroad. He has designed and directed the realization of the entrance of Teatro della Luna of Assago - Milano and also the master plan around Assago Forum for Cabassi Group. He is specialized in retail and museum projects, being for several years the exhibition design managing director for Luceplan. For Luceplan he also designed many lighting products. He won the Menzione d'Onore on the occasion of the 23rd edition of Compasso d'Oro for the category Exhibition Design with the exhibition "Gino Sarfatti, light design" at Triennale of Milan. He is lighting design professor at NABA, and product design professor at IED in Milan.

建築家、ミラノ在住。彼の活動はデザイナー、パオロ・リッツァートとの長きに渡るコラボレーションから始まった。1998年、ヤング&デザインコンクールで「ティツィアーナ・マスケローニ」賞を受賞。2000年、建築・デザイン事務所を構えた。様々な改修工事をエキジビションや照明計画を主体としてイタリアを始め海外のプロジェクトを手掛けた。ミラノ・アッサーゴの劇場施工およびフォーラム (多目的劇場、競技場施設) 周辺のマスタープランを「グルッポ・カバッシ」社のために設計を行った。展示ブース及び展覧会・展示デザインを中心として活動している。中でも照明メーカー「ルーチェプラン」社の展示ブースのデザインを行うとともに、数々の照明のデザインを行った。2014年ミラノ・トリエンナーレにおいて「ジーン・サルファッティ、光のデザイン」展のデザインを担当。これにより「コンパッソ・ドーロ」賞のエキジビション・デザイン部門で優勝。NABAにおいてライティング・デザインとIEDミラノのプロダクトデザインのコース指導を行っている。



GILLES DERAÏN

Designer francese nato nel 1944 e cresciuto professionalmente nel mondo del commercio d'arte e del modernariato. È stato tra i primi estimatori del movimento dell'UAM (Union des Artistes Modernes) un movimento attivo tra il 1928 e il 1958, che confluì poi nel movimento moderno internazionale. Direttore artistico e co-fondatore di Lumen Center a fine anni '70, la sua lampada MCP (Merci Chateau Pierre) nel 1979 costituì un enorme successo commerciale al punto da essere inclusa nella collezione del Museo di Arti decorative di Montreal. Tutt'oggi Derain progetta lampade, mobili, tappeti e gioielli.

French designer born in 1944 and professionally grown in trade of arts and modernism. He has been among the first to discover and study the UAM (Union des Artistes Modernes) a movement active between 1928 and 1958 that then merged into the International Modern Movement. Art director and co-founder of Lumen Center at the end of the Seventies, he designed MCP lamp (Merci Chateau Pierre) in 1979 that represented an enormous commercial success. For this reason it was included in the collection of the museum of decorative arts of Montreal. Today Derain creates lamps, pieces of furniture, carpets, jewels.

ジル・デレンは1944年生まれのフランス人デザイナー。若くより美術商としても活躍し、モダニズムにも親しむ。1928年から1958年にかけて興り、のちに国際近代運動へとつながる現代芸術家連盟 (UAM) を発掘し、調査した最初の人物の一人。1970年代末にはルーメンセンターを共同設立し、アート・ディレクターとして活躍。1979年にデザインした MCP (Merci Chateau Pierre) ランプが商業的に大成功を収め、モントリオールの装飾美術館のコレクションとして所蔵された。同氏は現在、ランプ、家具、カーペット、宝飾品を製作している。



FRANCESCO GIANNATTASIO
www.francescogiannattasio.it

L'architetto e designer Francesco Giannattasio dirige dal 2000 lo studio FGA Francesco Giannattasio Architects. FGA si occupa sia di progettazione architettonica che di interior design, spaziando tra vari ambiti di interesse: da quello residenziale a quello commerciale. Dalle collaborazioni con aziende private sono scaturiti progetti per il retail e il corporate design: esempi significativi sono lo sviluppo del concept di vari brand, per il settore dell'abbigliamento, della ceramica e del wellness in tutto il mondo. Lo studio si occupa anche di *lighting design* e *furniture design* vantando collaborazioni con prestigiose aziende. I suoi progetti sono stati scelti per i più importanti eventi internazionali di design e pubblicati sulle più importanti riviste specializzate di settore.

The architect and designer Francesco Giannattasio directs since 2000 the FGA studio "Francesco Giannattasio Architects". FGA is concerned with both architectural and interior design, ranging with great flexibility over different areas of interest: from residential to commercial. From collaborations with private companies projects have sprung for retail and corporate design: some examples are the concept development of different brands, for the clothing industry, ceramics and wellness around the world. FGA Studio also deals with lighting and furniture design boasting collaborations with prestigious companies. Over the years, FGA Studio has participated to many international design competitions, reaching important results. Its projects have been selected for the most famous international design events and then published in the most appreciated design magazines.

建築家、デザイナーとして FGA (フランチェスコ・ジャンナッタージオ・アーキテツク) ストゥーディオを2000年より指揮している。FGAは建築とインテリア・デザインの両面を手がけ、住宅から商業施設といった対象の異なる様々な領域に大いなる柔軟性を持って幅広く活動している。

個人企業のレタイルデザインからCI制作のコラボレーションをはじめとし、繊維工業や陶器、ウェルネス関連の国際企業に対して異なるブランドのコンセプト開発と言ったものが例として挙げられる。FGA ストゥーディオは照明機器、家具のデザインを通して数々の有名企業とやり取りを行っている。FGA ストゥーディオは長年にわたって数多くの国際コンクール参加し、重要な結果を残している。これらの作品は、国際的に有名なデザインイベントに選出され数多くのデザイン雑誌で紹介されている。



SETSUSHINOBU ITO
www.studioito.com

Setu and Shinobu Ito entrambi designer e architetti. Svolgono attività di consulenza tra Milano e Tokyo per importanti aziende internazionali. Le loro opere, pubblicate ed esposte in tutta Europa e Giappone, hanno ricevuto numerosi riconoscimenti come "The Good Design Award 2001" (Giappone) e "Premio Compasso d'Oro 2011" (Italia) ed alcune fanno parte della collezione permanente del Museo di Arte Contemporanea di Monaco. Oltre all'attività come progettista, Shinobu Ito, si occupa di grafica e marketing - competenze complementari al design che ha maturato durante gli anni trascorsi presso la CBS Sony. Setu Ito svolge, invece, attività accademica come docente presso il Politecnico di Milano, l'Università IUAV di Venezia, la Domus Academy e l'Istituto Europeo di Design - a Milano - e a Tokyo presso la Tsukuba University e la Tama Art University.

SETSUSHINOBU ITO both designers and architects. They cooperate as consultants with important international companies between Milan and Tokyo. Their works, published and exhibited all over Europe and Japan, have received several design awards such as "The Good Design Award 2001" (Japan) and Premio Compasso d'Oro 2011" (Italy) and some of them became permanent collections of "Die Neue Sammlung" International Design Museum in Munich. Besides her activity as designer, Shinobu Ito also works in graphic design and marketing, complementary competences she has developed during her cooperation at CBS Sony. Setu Ito is visiting professor at the Politecnico di Milano, IUAV University of Venice, Domus Academy and IED Istituto Europeo di Design in Milan and Tsukuba University and Tama Art University in Tokyo.

伊藤節&しのぶの二人はデザイナー・建築家である。彼らは、国際的に重要な企業とコンサルタントとしてミラノ東京においてコラボレーションを行っている。彼らの作品に関して、ヨーロッパ各地や日本にて本の出版および個展が開催されている。2001年日本のグッドデザイン賞、2011年イタリアのコンパッソ・ドーロ賞など数々のデザインアワードを獲得している。ミュンヘンのディニウサムラング国際デザイン博物館の永久保存コレクションとして数点が収蔵されている。伊藤しのぶはデザイナーとしての活動を行いつつ、グラフィックデザイン、マーケティングといった補完的なスキルをCBSソニー社時代に培った。伊藤節はミラノ工科大学、IUAVヴェネツィア大学、ドムスアカデミー、IED(ヨーロッパデザイン専門学校)ミラノ校、筑波大学、多摩美術大学の客員教授を歴任している。



MARIO MAZZER
www.mariomazzer.it

Nasce nel 1955, si laurea in Architettura e in Industrial Design. Collabora con i maestri Achille Castiglioni e Marco Zanuso. Partecipa come relatore a numerosi convegni e conferenze. Nel 1996 riceve a New York la menzione d'onore all'ID Annual Design Review. I suoi prodotti sono stati selezionati più volte nell'ADI Design Index e nell'International Design Yearbook. Nel 2001 esce la sua monografia: "Thinking about Things: Mario Mazzer designer". Viene inserito in "The Design encyclopedia", Moma New York 2004. Riceve il Good Design Award 2009-2010-2011-2013, il Red Dot Award 2010-2012-2013, e l'IF Product Design Award 2013-2014. Collabora e ha collaborato con le più importanti aziende dell'arredo. Nell'architettura opera nel restauro e nella progettazione di edifici residenziali, commerciali e direzionali, sia in Italia sia all'estero.

He was born in 1955, graduated in Architecture and Industrial Design. Collaborates with masters Achille Castiglioni and Marco Zanuso. In 1996 in New York receives honorable mention in ID Annual Design Review. His products have been selected several times in the ADI Design Index and the International Design Yearbook. In 2001 he published the monograph: "Thinking about Things: Mario Mazzer designer". He was included in "The Design encyclopedia", MoMA, New York, 2004. He has won the "Good Design Award" in 2009-2010-2011-2013, six "Red Dot Design Award" in 2010-2012-2013 and two "IF Product Design Award" in 2013-2014. Collaborates and has collaborated with the most important companies in the furniture field. In the architecture field operates both in Italy and abroad.

マリオ・マツエール1955年生まれ。建築・工業デザイン学を卒業。デザインの巨匠アキッレ・カスティリオーニやマルコ・ザヌーソの下で働いた。1996年ニューヨークにおいてID Annuale Design Review の名誉佳作賞を受けた。彼の数多くの作品は、ADI(イタリア工業デザイン協会)IndexやThe International Design Yearbookに選出されている。2001年には彼のモノグラフィーとして「Thinking About Things」が出版されている。また、彼は、2004年の MoMA (ニューヨーク近代美術館)のデザイン百科事典にも収録されている。Good Design Awardを2009-2010-2011-2013に受賞。Red Dot Design Awardを2013-2014の二度にわたって受賞している。家具業界において最も重要な家具メーカーとの仕事をしている。建築では、イタリアおよび海外におけるの経験を持つ。



NAKATA DESIGN

Fondato nel 2005 da Kiyoshi e Yoshiko Nakata, lo studio Nakata si occupa prevalentemente di product design oltre che di consulenza strategica, graphic design, marketing e strategia del colore. Entrambe i designer hanno lavorato per diversi anni in Panasonic Co. Ltd, Kiyoshi prevalentemente nel settore audio-video, collaborando alla nascita dei brand "Tau" e "Viera" e contribuendo alla fondazione del centro ricerche Panasonic a Milano; Noriko, in particolare, ha lavorato nel settore cucine progettando - sempre per Panasonic - il sistema "Fit". Attualmente entrambe insegnano presso importanti università di design giapponesi - Tama Art University di Tokyo, Kyoto University of Art&Design, Kyoto Seika University - e tengono seminari per professionisti sul colore.

NAKATA DESIGN was established in 2005 by Kiyoshi & Yoshiko Nakata. The Nakata office deals mainly with product design as well as strategic consulting, graphic design, marketing and colour strategy. Both designers have worked for several years in Panasonic Co. Ltd., Kiyoshi mainly in the audio-video area, developing the creation of the brands "Tau" and "Viera" and contributing to the establishment of the Panasonic research centre in Milan; Noriko, in particular, has worked in the kitchen sector planning - always for Panasonic - the "Fit" system. Currently both designers teach at important Japanese design universities - among which Tama Art University of Tokyo, Kyoto University of Art & Design, Kyoto Seika University - and they hold seminars for experts on colour matters.

NAKATA DESIGN は、中田希佳・中田賢子によって2005年に設立され、日本の東京と滋賀を拠点に、プロダクトデザインと企業コンサルティングに加え、マーケティングカラー戦略、グラフィックデザインにおいても取り組んでいる。中田希佳は、Panasonic株式会社において当時の世界を牽引するデジタルテレビ「TAU」「VIERA」2000年以降の商品をはじめ、AV機器や住宅設備機器のデザインを手掛ける。一方、欧州拠点イタリア、ミラノの立ち上げに尽力した。現在は多摩美術大学・プロダクトデザインの教授を務め、優秀なデザイナー達を世界へ輩出している。中田賢子は、同じくPanasonic株式会社において調理機器の世界展開デザインと共に住宅設備機器とシステムキッチンのヒットブランド「フィット」2001年以降の商品を手掛け、カラーセッションとして活躍。独立後は京都造形芸術大学、京都精華大学、その他の大学において教鞭を取り、プロ育成のカラーセミナーも行う。



ALBERTO SAGGIA / VALERIO SOMMELLA

ALBERTO SAGGIA nasce a Novara nel 1978. Laureatosi nel 2004 al Politecnico di Milano in Disegno Industriale con specializzazione illuminotecnica, subito inizia la collaborazione con lo studio Metis Lighting di Milano, occupandosi di lighting design e industrial design, oltre allo sviluppo di soluzioni illuminotecniche custom made. VALERIO SOMMELLA nasce a Cortona nel 1980. Si laurea con lode in Disegno Industriale al Politecnico di Milano nel 2004, anno in cui inizia a lavorare con Stefano Giovannoni. Nel 2007 lascia Milano per trasferirsi ad Amsterdam dove entra a far parte del team di Marcel Wanders. Dal 2009 vive e lavora a Milano progettando prodotti che spaziano all'illuminazione all'elettronica di consumo per clienti italiani e internazionali. Dal 2010 collaborano insieme allo sviluppo di apparecchi e sistemi di illuminazione per note aziende italiane.

ALBERTO SAGGIA was born in Novara in 1979. In 2004 he graduated in Industrial Design with a specialization in lighting design at Politecnico of Milan. Soon after he started his collaboration with Metis Lighting Studio in Milan designing for both the industrial and lighting field and where he also projects custom made lighting solutions. VALERIO SOMMELLA was born in Cortona in 1980. He graduated cum laude in Industrial Design at Politecnico of Milan in 2004 and, in the same year, he started working with Stefano Giovannoni. In 2007 he moved to Amsterdam to join Macel Wanders design team. Since 2009 he lives and works in Milan designing a wide range of products, from lighting to consumer electronic appliances for both Italian and international companies. Since 2010 they work together developing lighting products and systems for important Italian lighting companies.

アルベルト・サグジャは1979年ノヴァーラに生まれる。2004年ミラノ工科大学工業デザイン学部照明デザイン専門課程を卒業。その後すぐ、ミラノのメーティス照明事務所とのコラボレーションを開始。特注照明機器をはじめとし工業デザインと照明デザインの双方において活動。ヴァレリーオ・ソーンメッラ1980年コルトーナに生まれる。2004年ミラノ工科大学工業デザイン学部を卒業。同年ステファノ・ジョバンノニと共に働き始める。2007年アムステルダムに移り、マルセル・ワンダースデザインチームに加わる。2009年より、彼は、ミラノに戻り照明からコンシューマー電化製品に至るまでイタリアおよび国際企業の双方に対し幅広く製品のデザインを行っている。2010年以降、彼らは共に有名なイタリア照明製造会社のため照明機器の開発を行っている。



JEAN-MICHEL WILMOTTE
www.wilmotte.com

Nel 1975 Jean-Michel Wilmotte fonda il suo studio di architettura Wilmotte & Associates a Parigi con attività che spaziano dalla progettazione architettonica alla pianificazione urbanistica, dal product design al museum design. Oggi, Wilmotte & Associates si struttura attorno a due attività principali: lo studio di architettura Wilmotte & Associates e lo studio di design Wilmotte & Industries, che lavorano contemporaneamente su centinaia di progetti. Conosciuto per il suo approccio eclettico e orientato alla raffinatezza dei dettagli attraverso l'utilizzo di materiali di altissima qualità, Jean-Michel Wilmotte progetta negozi, hotel di lusso, abitazioni, e strutture pubbliche - solo per citare alcuni esempi. Wilmotte & Associates opera in oltre venti paesi con uno staff totale di 201 persone. Nel 2005, ha inoltre creato la Fondazione Wilmotte al fine di conquistare i più alti standard di design e trasmettere l'eccellenza di questi valori ad una nuova generazione di architetti.

In 1975, Jean-Michel Wilmotte founded his architectural practice Wilmotte & Associates in Paris. The firm's activities range from architectural projects to urban planning and product design to museum design. Today, Wilmotte & Associates is structured around two main entities - the architectural practice Wilmotte & Associates and the design studio Wilmotte & Industries, which are simultaneously working on hundreds of schemes. Recognized for his eclectic approach of detailing with the highest quality materials, Jean-Michel Wilmotte designs shopping, luxury hotel, housing, and public facilities. to quote a few examples. With 20 different nationalities and 201 staff, Jean-Michel Wilmotte's practice works in over twenty countries. In 2005 Jean-Michel Wilmotte created the Wilmotte Foundation to encourage the highest standards of contemporary design on existing buildings amongst a new generation of architects.

1975年ジャン＝ミシェル・ウィルモットは彼の建築事務所「ウィルモット&アソシエーツ」をパリに創設。建築、都市計画、プロダクトデザイン、ミュージアムデザインと幅広く活動を行う事務所である。現在、「ウィルモット&アソシエーツ」は建築関連業務とウィルモットデザイン&インダストリーの二つの事業主体によって成り立っている。そこでは、数多くの事業が常に同時進行している。高級ホテル、個人住宅、公共施設など手がける中、最高品質の材料を元に彼のエキセントリックなディテールに対するアプローチは周知のものである。これには数々の例が挙げられる。20カ国の異なる人種による201名のスタッフを抱え、ジャン＝ミシェル・ウィルモット事務所は20カ国以上の仕事を行っている。2005年ジャン＝ミシェル・ウィルモット財団を創設することによって、従来の建造物を介してコンテンポラリーデザインの最高峰の水準を促進するべく新世代の建築家の育成に励んでいる。

MILESTONES

LUMEN CENTER ITALIA

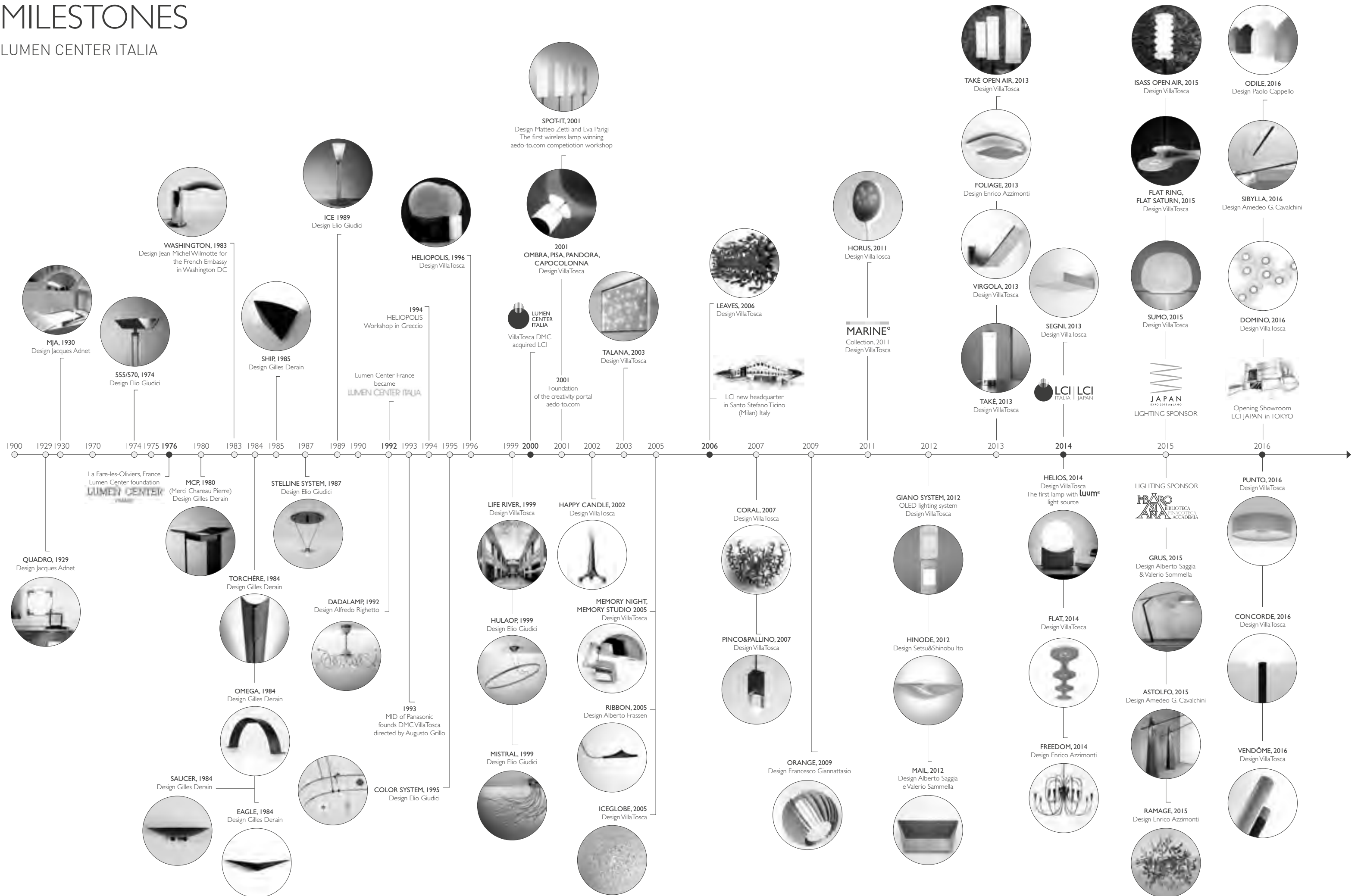

INDEX

NEW PRODUCTS



BRICK QUADRO 1/4 20
BRICK RETTO 2/4 20



BRAC 1 24
BRAC 4 24
BRAC 6 24
BRAC 10 24



DOMINO 28
DOMINO ZERO 28



PUNTO 32
PUNTO P 32



ODILE SM 36
ODILE PEN 3/5 38



SIBYLLA S 42
SIBYLLA M 42



SIBYLLA L 42
CONCORDE 46
VENDÔME 50



ICEGLOBE S/LS 96
IG MAXI S/GIANT S 96
IG SEMI MAX/SEMI GIANT 98
IG 2I/2IL 100
IG 9/10/11/12 102
IG L9/L10/L11/L12 104



IG 03/L03 106
IG 02/L02 108
IG MAXI 02/GIANT 02 108
IG BUBBLE 3/5/10 110
IG BUBBLE MINI 3/5/10 110

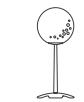

ICEGLOBE MINI 02 112
IG MINI S 112
IG MINI 2I 112
IG MINI 2IB/2IBL 114



ICEGLOBE MICRO 03 116
IG MICRO 2I/2I-I 118
IG MICRO S/S-I 118
IG MICRO BUBBLE 4/8/12/16 118
IG MICRO A2/A4/A6 120
IG MICRO P 122
IG MICRO 16L 122



ICELIGHT 20/30/45/60/60SEMI 126
ICELIGHT PEN 3/5 127



LEAVES S 130
LEAVES 2I 130
MIDLEAVES 130
SUPERLEAVES 130



MAIL 136
MAIL S 136
MAIL L 138
MAIL XL 138



PINCO 2I/2I-I 144
PINCO S/S-I 144
PALLINO 2I/2I-I 146
PALLINO S/S-I 146
PALLINO LIP 2I/2I-I 148
PALLINO LIP S/S-I 148



RAMAGE 152
RAMAGE II 152



SEGNO QUADRO 156
SEGNO RETTO 156
SEGNO TONDO 156
SEGNO TRINO 156
SEGNO GIRO QUADRO 158
SEGNO GIRO TONDO 158
SEGNO MAXI QUADRO 160
SEGNO MAXI RETTO 160
SEGNO MAXI DOUBLE 160



SKYLINE 164
SKYLINE S 164
SKYLINE 2I 164



SUMO S/M/L/X 168
SUMO 2I/M2I/L2I 170
SUMO MII/MI2 172
SUMO 02/M02/L02/X02 174

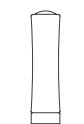

TAKÉ PLUS TOUCH 01 178
TAKÉ PLUS TOUCH 02/03 180
TAKÉ PLUS TOUCH 04/05/06 182
TAKÉ PLUS BT OVAL 05/06 184
TAKÉ PLUS BT S&P 04/05/06 186
TAKÉ PLUS ON-OFF S1/S2/S3 188
TAKÉ PLUS ON-OFF S4/S5/S6 188
TAKÉ PLUS 2I 190
TAKÉ 27/27-I 192
TAKÉ BUBBLE 04/08 192



VIRGOLA 196

CLASSIC

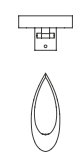

555 LED 200
570 LED 200
BLUM LED 202
EAGLE LED 204
HELIOLED 206



HELIOS 208
ICE 210
ICE II 210
ICE 2I 210

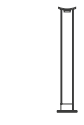

MCP LED 212
MEMORY STUDIO 214
MEMORY NIGHT 214
MJA 216



OMEGA LED 218
QUADRO VII RE-EDITION 220



MISTRAL LED 222
RDS LED 222
SAUCER LED 224
SAUCER A LED 224



SHIP LED 226
TORCHÈRE LED 228

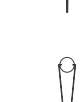

TRYLON LED 230
GRANDTRYLON 230



GRAF 231
TUCA 232



VICTORY LED 234
WASHINGTON LED 236

OUTDOOR

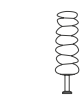

ISASS OPEN AIR 3 242
ISASS OPEN AIR 10 242
ISASS OPEN AIR 11 242

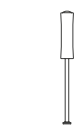

TAKÉ OPEN AIR 03 246
TAKÉ OPEN AIR 10 246
TAKÉ OPEN AIR 11 246
TAKÉ OPEN AIR 2I 248

CONTEMPORARY

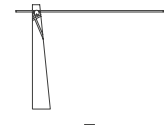

ASTOLFO 56
ASTOLFO HT 58

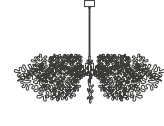

CORAL 62
CORAL P 62
SUPERCORAL 8L 64
SUPERCORAL 16L 64
CORAL 2I 66
MINICORAL S 68
MINICORAL A 68
MINICORAL P 68

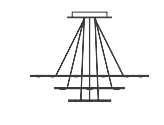

FLAT 04/05/06 72
FLAT RING 3/6/12 74
FLAT SATURN 1/2/3 76



FOLIAGE 80
FOLIAGE P 80

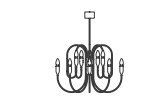

FREEDOM 10L/16L 84



GRUS 88
HINODE 92

BRICK / BRAC / DOMINO

Design VillaTosca 2016

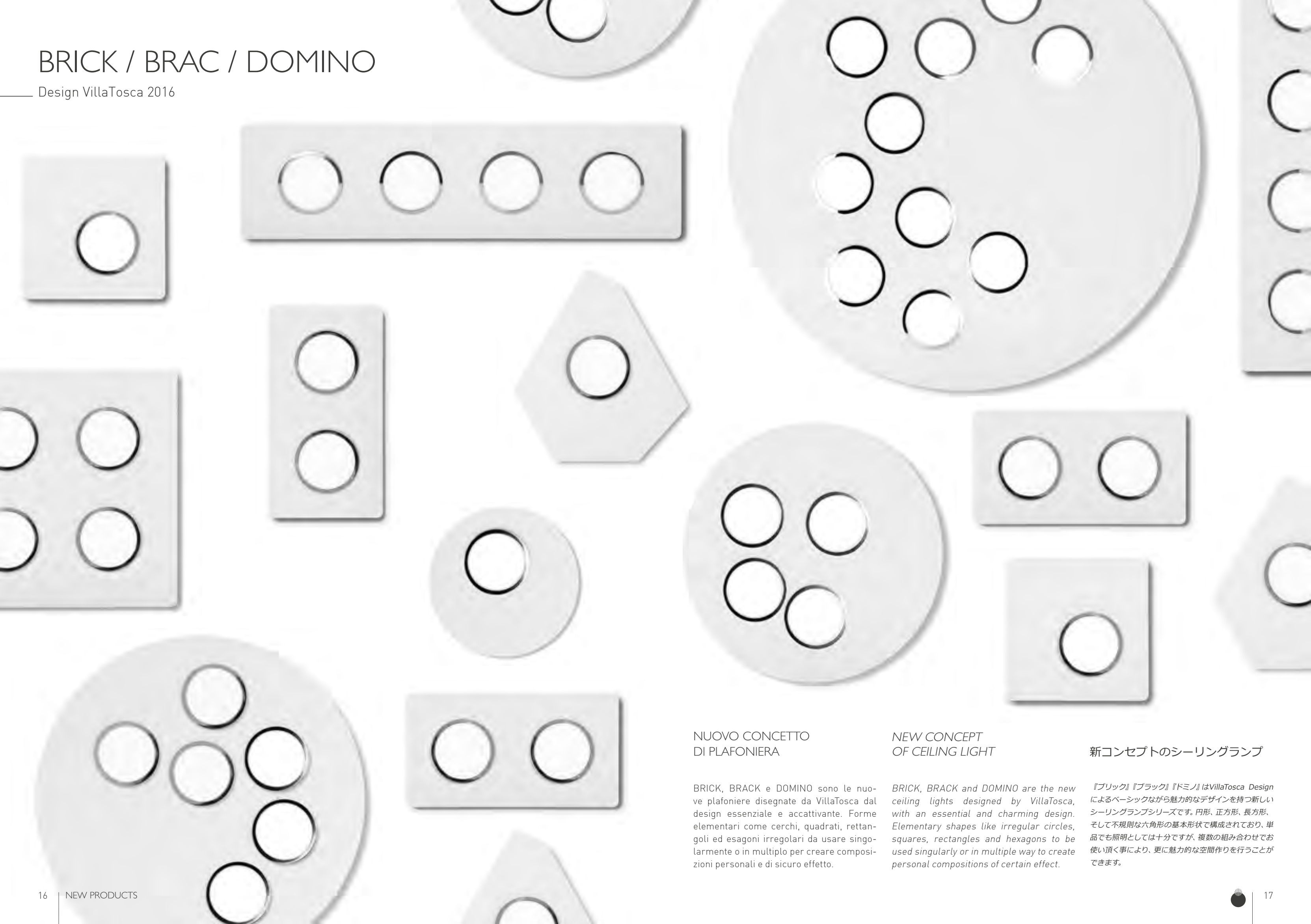

NUOVO CONCETTO DI PLAFONIERA

BRICK, BRACK e DOMINO sono le nuove plafoniere disegnate da VillaTosca dal design essenziale e accattivante. Forme elementari come cerchi, quadrati, rettangoli ed esagoni irregolari da usare singolarmente o in multiplo per creare composizioni personali e di sicuro effetto.

NEW CONCEPT OF CEILING LIGHT

BRICK, BRACK and DOMINO are the new ceiling lights designed by VillaTosca, with an essential and charming design. Elementary shapes like irregular circles, squares, rectangles and hexagons to be used singularly or in multiple way to create personal compositions of certain effect.

新コンセプトのシーリングランプ

『ブリック』『ブラック』『ドミノ』はVillaTosca Designによるベーシックながら魅力的なデザインを持つ新しいシーリングランプシリーズです。円形、正方形、長方形、そして不規則な六角形の基本形状で構成されており、単品でも照明としては十分ですが、複数の組み合わせでお使い頂く事により、更に魅力的な空間作りを行うことができます。

BRICK

Design VillaTosca 2016



FORME ELEMENTARI

Forme elementari, una "evergreen" che richiama alla mente i "mattoncini della nostra infanzia". Cerchi di luce iscritti nelle più rigide geometrie del quadrato e del rettangolo.

ELEMENTARY FORM

Elementary form, an "evergreen", that reminds the "building blocks of our childhood". Circles of light inserted in the most rigid geometries of the square and the rectangle.

ベーシックなフォルム

ベーシックなフォルムを纏ったシーリングランプです。『不朽』とも言えるそのシンプルなデザインは、子供の頃に見たブロックを連想させます。円状の光は正方形と長方形の最も幾何学的な板面にその姿を落とします。

BRICK QUADRO 1/4 - RETTO 2/4

Design VillaTosca 2016

Ingenuità e rigore si uniscono in questa plafoniera dal design essenziale, quasi grafico. Tre moduli base. Un quadrato e due rettangoli nei quali sono iscritti cerchi di luce. Mattoncini luminosi da usare singolarmente o da accostare liberamente, per costruire soluzioni geometriche di qualunque dimensione e per ogni tipologia di ambiente. Realizzati in metallo con finitura bianca fine textured (FT) e anelli cromati.

Naivety and rigour are combined in this ceiling lamp of essential design, almost graphic. Three basic modules: a square and two rectangles in which circles of light are inscribed. Bright bricks that can be combined individually or stacked freely, for building geometric solutions of any size and for any type of location. Made of metal with white fine textured (FT) finish and chromed rings.

創意工夫を凝らし天井に緻密にベーシックなフォルムを並べ、お気に入りの形を創作する楽しさ、それはまるでグラフィックデザインの世界です。構成は3つの基本形、正方形と2つの別の形の長方形となっており、その上に円形の光源が収まります。単品でもご使用いただけますが、空間にあわせて複数をご組み合わせることでより魅力的な空間を創作して頂くことも可能です。素材はメタル製で仕上げはファインテクスチャー(FT)仕上げのホワイト、光源部のリングはクロムメッキです。

QUADRO 1

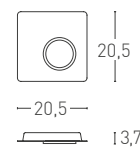

QUADRO 4

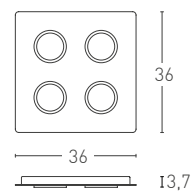

RETTO 2

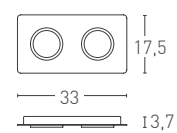

RETTO 4

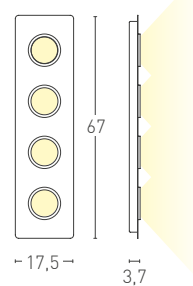

Units: cm



Finishes

○ 105FT White

Ring:

● 150 Chrome

Diffuser

PMMA methacrylate diffuser

Electronic driver

Dimmable included TRIAC

Light source

LED

220/240V 2700K CRI>90

QUADRO 1 1x5,8W 690lm

QUADRO 4 4x5,8W 2760lm

RETTO 2 2x5,8W 1380lm

RETTO 4 4x5,8W 2760lm

A

Certification

CE EAC F IP20 Classe I

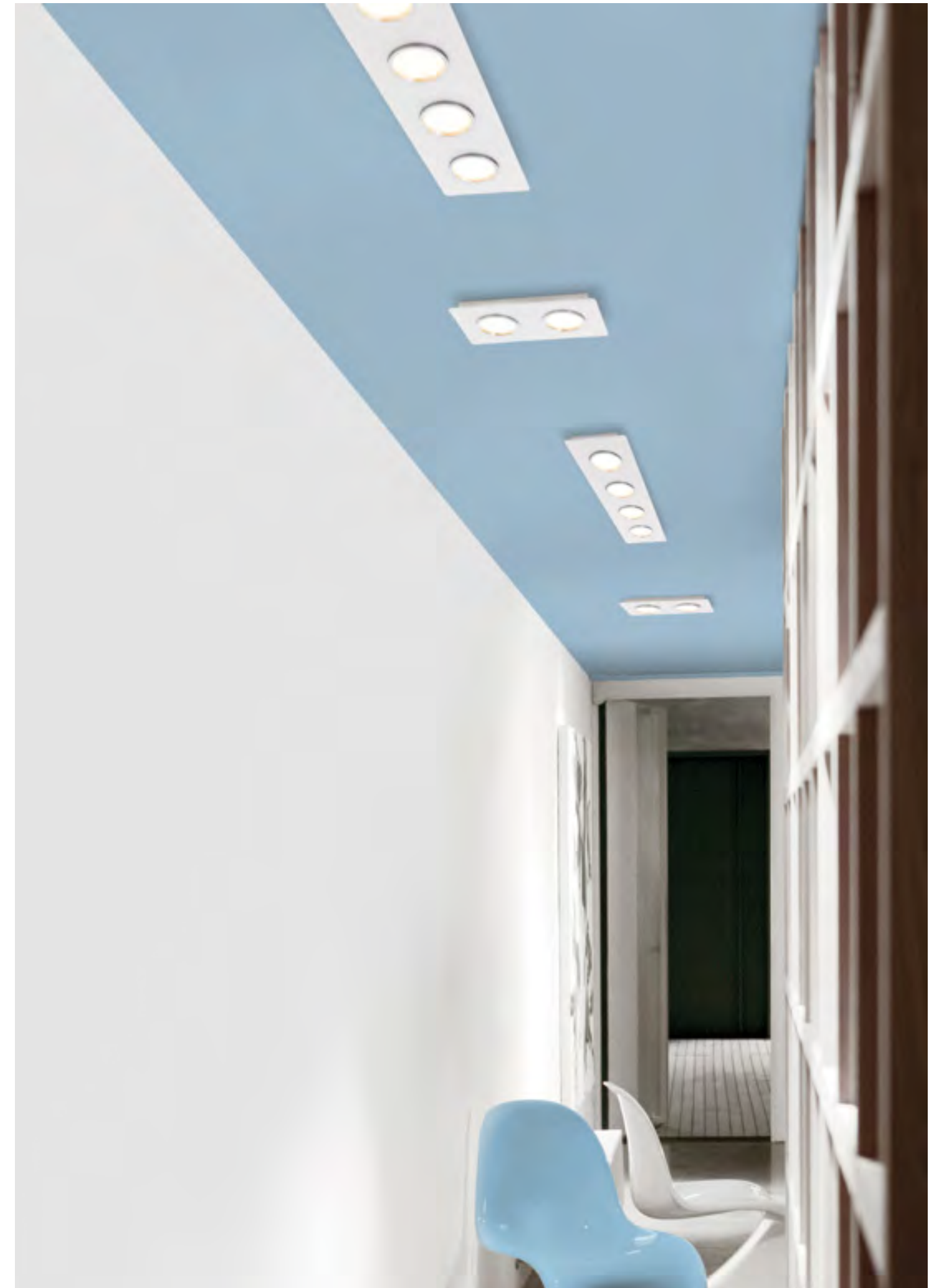



PUREZZA DEL CERCHIO

La purezza del cerchio che include altri cerchi di luce posti in libertà. Un ossimoro che sorprende ed esalta la semplicità del cerchio.

CIRCLE PURITY

The purity of the circle that includes other circles of lights placed freely. An oxymoron that surprises and underlines the simplicity of the circle.

純粹な円

魅惑的なデザインのシーリングランプです。真円の上いくつかの光の円が自由に配置されています。シンプルな円のみで構成されているのに、驚きを与える辺りの矛盾さをデザインに生かしました。

BRAC 1/4/6/10

Design VillaTosca 2016

Le plafoniere BRAC, nella loro purezza e semplicità, disegnano cerchi di luce che richiamano cangianti giochi d'acqua. Gocce di luce distribuite con apparente casualità su una superficie rotonda. La purezza del design offre nuove suggestioni. Moltiplicate a soffitto le lampade BRAC creano composizioni dinamiche. Realizzati in metallo con finitura bianca fine textured (FT) e anelli cromati.

The ceiling lamps BRAC, in their simplicity and minimalism, draw light circles that remind bright water effects. Drops of light arranged on a round surface. The design purity always offers new suggestions. Several BRAC ceiling lamps create dynamic compositions.
Made of metal with white fine textured (FT) finish and chromed rings.

シーリングタイプの照明『ブラック』は、ミニマリズム的なシンプルさの中に描かれた光の水滴を思わせる光源を持ち、その光のしずくは円状の表面に広がります。デザインは基本に立ち返った時に常に何か新しい提案を与えてくれます。もし「BRAC」を複数組み合わせれば思いがけない空間を創作できることでしょう。素材はメタル製で仕上げはファインテクスチャー(FT)仕上げのホワイト、光源部のリングはクロムメッキです。



Finishes

- 105FT White
- Ring:
- 150 Chrome

Diffuser

PMMA methacrylate diffuser

Electronic driver

Dimmable included TRIAC

Light source

LED

220/240V 2700K CRI>90

BRAC 1 1x5,8W 690lm

BRAC 4 4x5,8W 2760lm

BRAC 6 6x5,8W 4140lm

BRAC 10 10x5,8W 6950lm

A

Certification

CE EAC F IP20 Classe I

BRAC 1

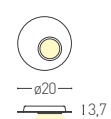

BRAC 4

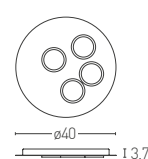

BRAC 6

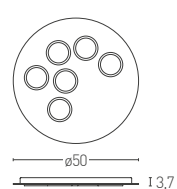

BRAC 10

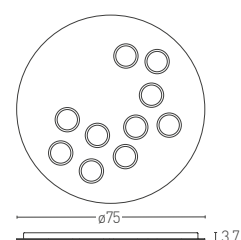

Units: cm

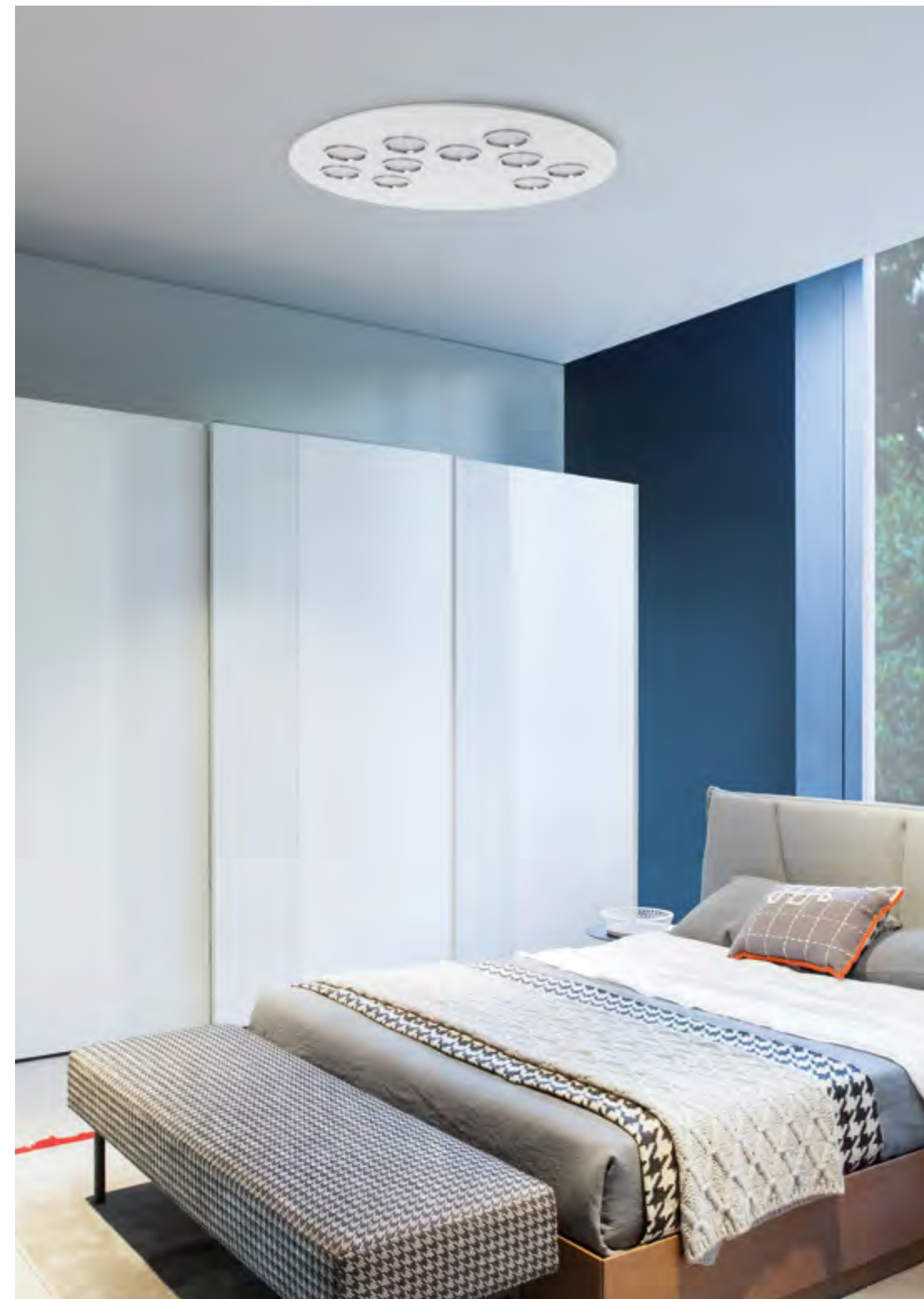

DOMINO

Design Villa Tosca 2016

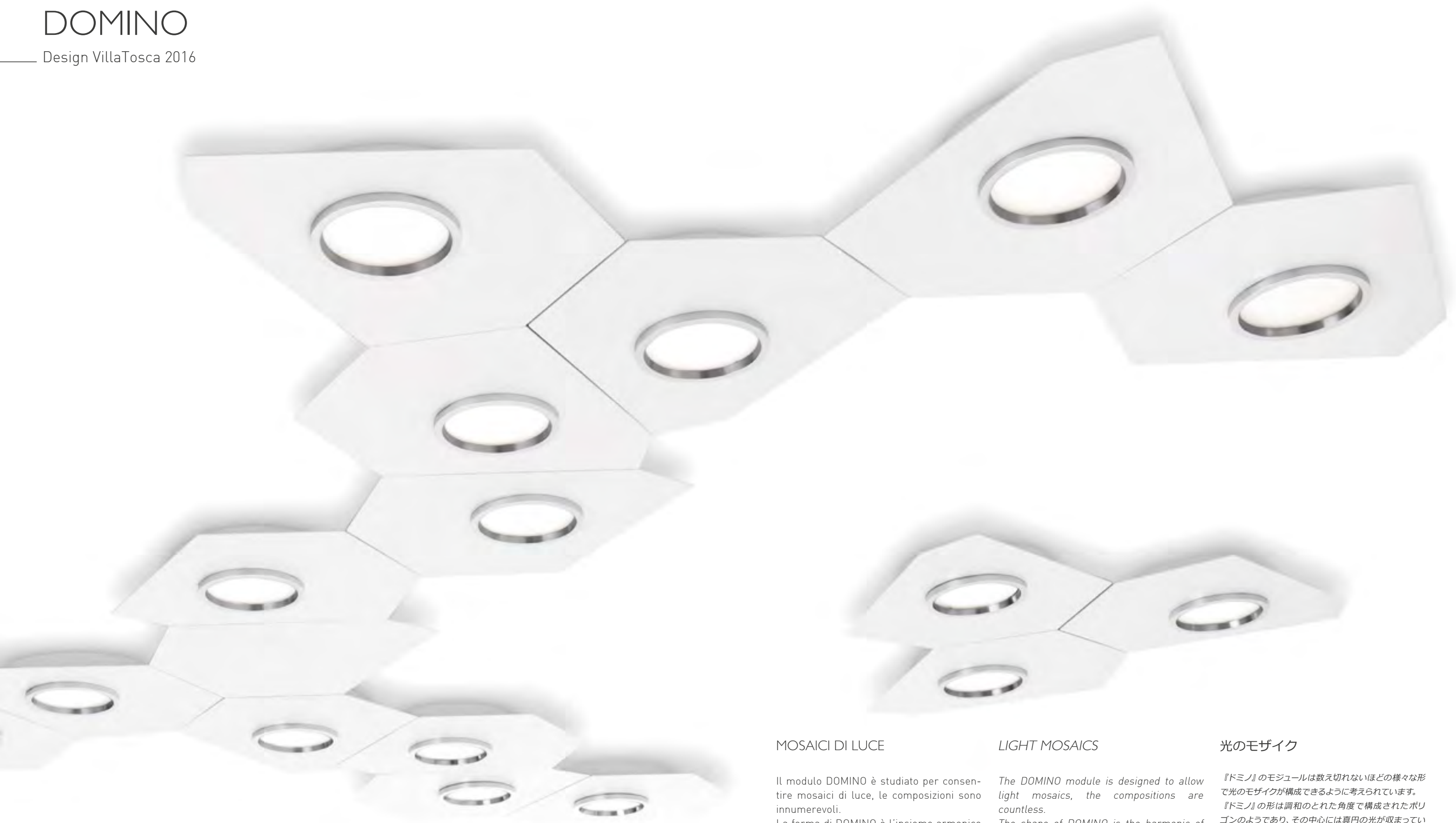

MOSAICI DI LUCE

Il modulo DOMINO è studiato per consentire mosaici di luce, le composizioni sono innumerevoli.

La forma di DOMINO è l'insieme armonico degli angoli e degli spigoli del suo poligono irregolare con il cerchio di luce al suo interno.

LIGHT MOSAICS

The DOMINO module is designed to allow light mosaics, the compositions are countless.

The shape of DOMINO is the harmonic of the corners and the edges of its irregular polygon with the circle of light in the interior.

光のモザイク

『ドミノ』のモジュールは数え切れないほどの様々な形で光のモザイクが構成できるように考えられています。

『ドミノ』の形は調和のとれた角度で構成されたポリゴンのものであり、その中心には真円の光が収まっています。

DOMINO

Design Villa Tosca 2016

Un esagono irregolare e un cerchio di luce al suo interno. Questa è la matrice di infinite combinazioni possibili. DOMINO è un nuovo concetto di plafoniera. Un sistema che invita a comporre e accostare le diverse tessere di un mosaico di luce sempre diverso. Come nell'antico gioco cinese del tangram o in un frattale della natura, la logica delle composizioni è aperta e creativa. Realizzati in metallo con finitura bianca fine textured (FT) e anelli cromati.

An irregular hexagon and a light circle in its inside. This is the origin of possible endless combinations. DOMINO is a new concept of ceiling lamp. A system that invites to combine different tiles of an always new light mosaic. As in the Chinese game of tangram or in a nature fractal, the logic of the compositions is open and creative. Made of metal with white fine textured (FT) finish and chromed rings.

不規則な六角形の中心に光の輪。これは無限の組合せが可能なマトリックス(基盤)です。『ドミノ』は天井の新しい概念です。光のモザイクは無限の組み合わせにより様々な違った空間へあなたを誘います。それはタングラム(古代中国のバズル)や自然界のフラクタルの様にあなたの開かれたアイデアの前で無限に広がっていきましょう。素材はメタル製で仕上げはファインテクスチャー(FT) 仕上げのホワイト、光源部のリングはクロムメッキです。

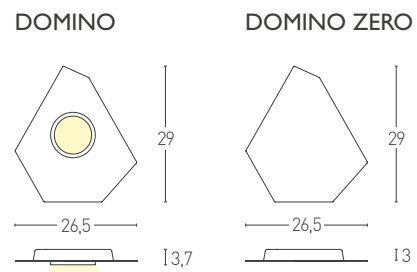
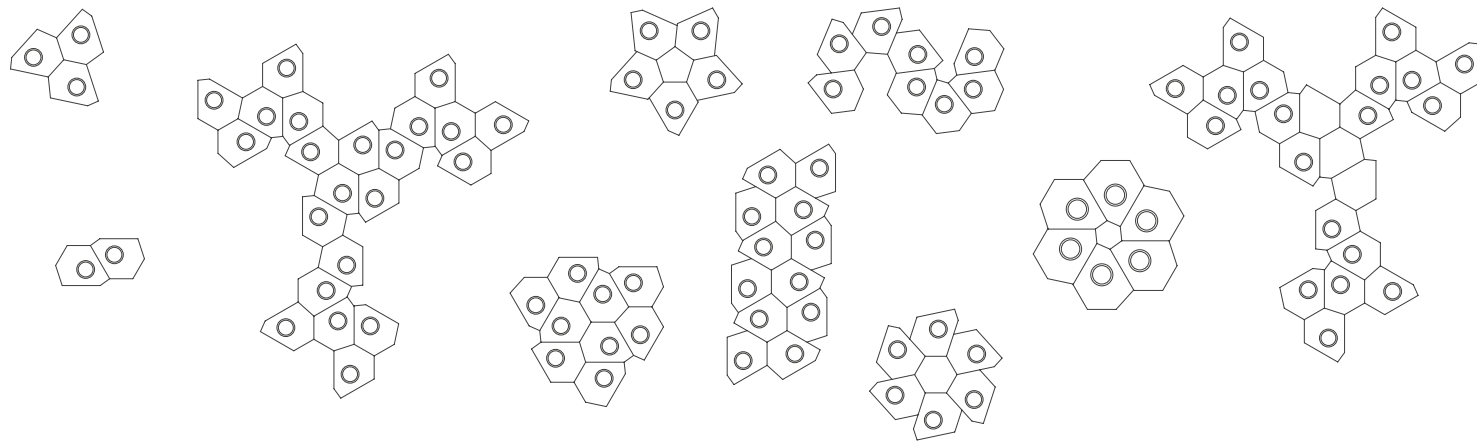

Units: cm



Finishes

- 105FT White
- Ring:
- 150 Chrome

Diffuser

PMMA methacrylate diffuser

Electronic driver

Dimmable included TRIAC

Light source

LED

LED 1x5,8W
220/240V 690lm 2700K CRI>90



Certification

CE EAC F IP20 Classe I



PUNTO

Design VillaTosca 2016



PUNTO DI LUCE

Un punto in un punto di luce. Plafoniera di grande versatilità, richiama con i puntini luminosi che traspaiono dal diffusore le analisi di Fibonacci sulla disposizione dei semi di girasole.

POINT OF LIGHT

A point in a point of light. Ceiling lamp of great versatility, recalls, with bright shining dots, the Fibonacci analysis of sunflower seeds.

点の光

『ポイント』は点の光です。非常に汎用性の高いシーリングランプであり、発光面に浮かぶ小さな光の点はフィボナッチの法則に基づいた、ひまわりの種の配列を思わせます。

PUNTO / PUNTO P

Design VillaTosca 2016

Le leggi della natura e quelle della matematica si incontrano in un corpo di luce essenziale e versatile. I delicati puntini luminosi che traspaiono dal diffusore riprendono l'affascinante spirale dei semi di girasole, di cui il matematico Fibonacci aveva colto il ritmo numerico. La forma a cerchio della plafoniera viene ripresa dal punto centrale. Più plafoniere disposte in libertà sbocciano sul soffitto come eleganti fiori geometrici.

Laws of nature and mathematics meet in an essential and versatile body of light. The soft light small spots that shine from the diffuser remind the fascinating spiral of sunflower seeds that the mathematician Fibonacci studied and discovered numerical rhythm behind it. The circle shape of the ceiling lamp is recalled in the central point. Several ceiling spots create on wall elegant geometric flowers shadows.

自然の法則から導き出された数学の世界が照明の上に重なり合います。照明の発光面に浮かぶ光の点で作られる魅力的な幾何学模様、それは数学者フィボナッチによって定義つけられたひまわりの種の配列を模した螺旋模様です。中心の小さな点から照明本体の淵にあたる円までその螺旋は広がっていきます。天井に配置されたこのシーリングランプは天井にエレガントな幾何学模様の花を咲かせます。



PUNTO P

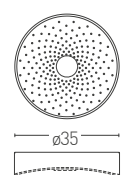

PUNTO

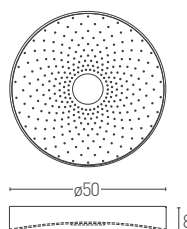

Units: cm

Finishes

- 105FT White
- 115R FT Sand grey
- 125FT Anthracite grey

Diffuser

PMMAD methacrylate diffuser

Electronic driver

Dimmable included TRIAC

Light source

LED

LED TOTAL POWER
220/240V 3000K CRI>90
PUNTO P 21W 2700lm
PUNTO 33W 4300lm



Certification

CE EAC F IP20 Classe I



ODILE

Design Paolo Cappello 2016



SILHOUETTE ELEGANTE

Sospensione morbida e iconica che unisce essenzialità ed eleganza delle forme suscitando una piacevole sensazione di semplicità ed equilibrio.

ELEGANT SILHOUETTE

Soft and iconic suspension that combines essentiality and elegance of the forms arousing a feeling of simplicity and balance.

エレガントなシルエット

柔らかな印象のペンダントランプで、記号的とも言えるそのフォルムには誰もが好むようなシンプルで、バランスの取れた形の中に上品さを併せ持っています。

ODILE S/M

Design Paolo Cappello 2016

Forme sussurate, linee tratteggiate con dolcezza e uno studio del colore che rende l'effetto d'insieme ancora più gentile e delicato. Le lampade a sospensione ODILE, con la loro avvolgente silhouette a campana, sono una presenza misurata e elegante nello spazio. La palette di toni pastello mat, per i modelli proposti in due dimensioni, valorizza con discrezione la purezza del design.

Whispered shapes, sweet outlines and color study make ODILE, suspension lamp, delicate and gentle.

With its charming silhouette, the suspension ODILE is an elegant and chic furnishing element. The mat pastel tones palette, for the following models proposed in two dimensions, enhance with discretion the design purity.

ささやくような淡いフォルム、消え入るような繊細な線。甘く柔らかな雰囲気と色の探求、その全てが一つに合さり誰かが好むであろう、一つの結果に集約します。

『オディーレ』は鐘のようなシルエットを纏ったペンダントランプであり、ご使用になる様々な空間どこであってもエレガントな存在感を示します。

表面の仕上げはパステル調の柔らかなつや無し塗装で、形は究極に研ぎ澄まされた大小違ったフォルムの2種類からなります。

ODILE S ODILE M

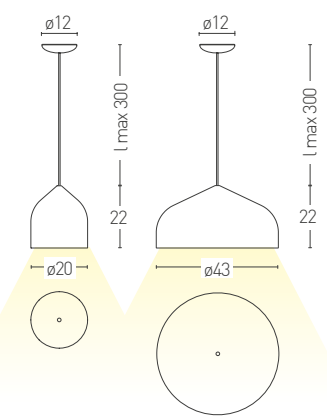

Units: cm



Finishes

- 105FT White
- 125FT Anthracite grey
- 126FT Sage green
- 127FT Senape

Ceiling rose

ABS white

Cable

Transparent

Suggested light source

- ☞ E27 Halogen ECO
- ☞ E27 ECO Fluo
- ODILE S 1x55W max
- ODILE M 1x77W max

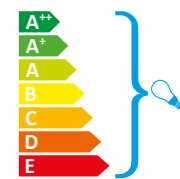

Certification



ODILE PENDANT 3/5

Design Paolo Cappello 2016

Attacco al soffitto bianco opaco dotato di 3 o 5 bracci disposti a raggera che consente la libera configurazione delle sospensioni ODILE S e M.

Matt white ceiling connection provided with 3 or 5 ray system arms that makes possible the free configuration of suspension lamps ODILE S and M.

『オディーレ』SとMをお好きな組み合わせでまとめることのできるアタッチメントです。3本もしくは5本の放射状に広がるアームを持つ天井用ベースキットはつや消しのホワイト仕上げです。



Finishes

- 105FT White
- 125FT Anthracite grey
- 126FT Sage green
- 127FT Senape

Ceiling rose

- 106 Matt white

Cable

Transparent

Suggested light source

- ☹ E27 Halogen ECO
- ☹ E27 ECO Fluo
- ODILE S 1x55W max
- ODILE M 1x77W max

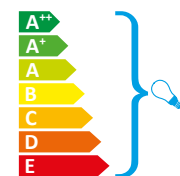

Certification

CE EAC IP20

ODILE PENDANT 3

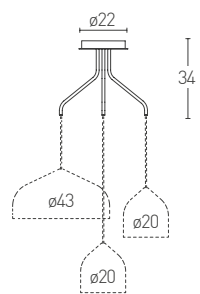

— ø max 80 —

ODILE PENDANT 5

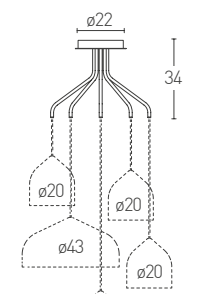

— ø max 80 —

Units: cm



SIBYLLA

Design Amedeo G. Cavalchini 2016

RAGGIO DI LUCE

"Un raggio di luce rubato al sole".
SIBYLLA modula la temperatura colore della luce. Oltre ai toni caldi e freddi è possibile variare anche l'intensità luminosa.
Le sospensioni sono dotate di un sistema saliscendi per variare la loro distanza dai soffitti e dalle superfici che illuminano.

RAY OF LIGHT

"A ray of light stolen from the sun".
SIBYLLA offers the possibility to vary the color temperature of light and its intensity (warm and cold tones). The suspensions are equipped with a system to vary their distance from the ceilings and surfaces that illuminate.

光の線

「朝から夕の光を再現」
『シビッラ』は光の色温度を変えることができます。色温度の低い暖かな光から色温度の高い清んだの変化に加え光の強さも変化させることができます。これらのペンダントランプの中には、天井からの高さが調整できる機構が内蔵されています。

SIBYLLA S/M/L

Design Amedeo G. Cavalchini 2016

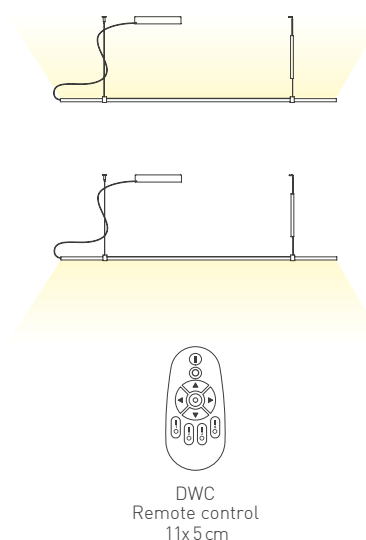
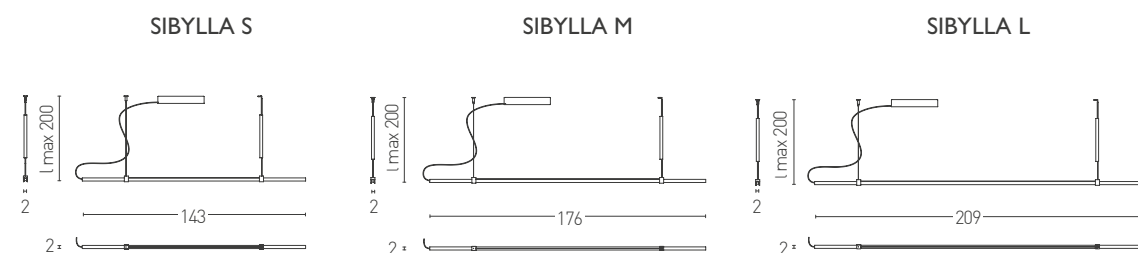

Con la sua forma allungata, una semplice barra in alluminio regolabile in altezza, SIBYLLA esprime la punta avanzata nella ricerca del light design. La sofisticata tecnologia dei LED a luce dinamica permette di controllare non solo l'intensità, ma anche la temperatura colore della luce. Tramite telecomando si può passare liberamente da 2700 gradi Kelvin, che corrispondono alla luce del sole poco prima del tramonto, a 6300 gradi Kelvin, con un effetto sole in pieno giorno.

A tre diverse lunghezze 143 cm, 176 cm e 209 cm, SIBYLLA crea scenografie luminose sempre nuove anche grazie al sistema saliscendi che ne varia la distanza dal soffitto e dalla superficie che illumina.

With its long shape, a simple height-adjustable aluminium bar, SIBYLLA is master level in light design research. The sophisticated technology of dynamic LED light allows the control of intensity but also the color temperature of light. Via remote you can freely switch from 2700 Kelvin, which corresponds to sunlight just before sunset, to 6300 Kelvin, full daylight.

With three different lengths 143 cm, 176 cm and 209 cm, SIBYLLA always creates new lights sceneries thanks to the latch system that lead to change the distance from the ceiling and from the lighted up surface.

『シビラ』は一見すると細長いシンプルなアルミ製の照明ですが、簡単に高さの調整が可能であるなど、最新のデザインを持つペンダントランプです。

機能面だけでなく光源部も最新のLED技術が盛り込まれており、光の強さだけでなく光の色温度までも調節が可能です。リモコンにより夕焼け前の色温度2700Kから日中の色温度6300Kの色温度までを再現する事が出来ます。『シビラ』は3つの異なるサイズで構成されており、そのサイズは143cm、176cm、209cmとなります。これらのペンダントランプの中には、天井からの高さが調整できる機構が内蔵されています。

SET-UP MODALITIES

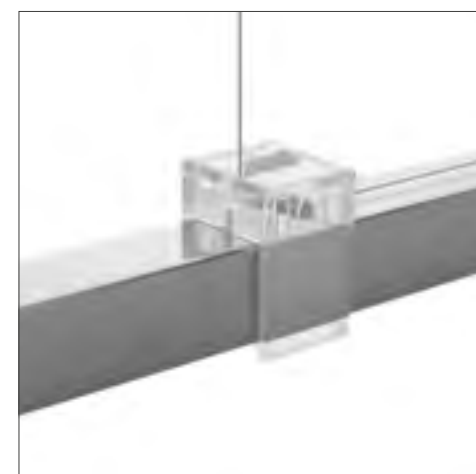
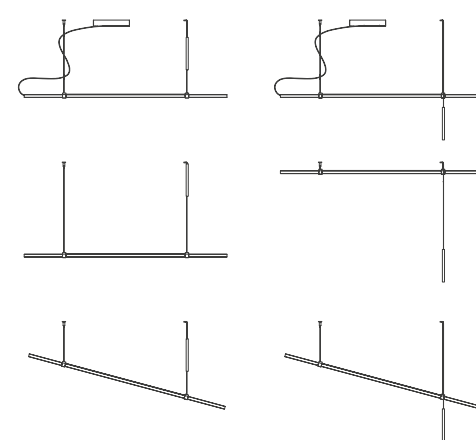

Finishes

- 172 Natural anodized aluminium
- 174 Black anodized aluminium

Diffuser

PMMA methacrylate

Clips

Black plastic or transparent plastic

Counterweight cylinder

- 150 Chrome

Ceiling rose

- 105FT White (outside)
- 103FT Black (inside)

Cable

Black with steel stop and steel wire

Electronic driver

Dimmable included

Dimmer

Remote control included

Light source

LED

LED TOTAL POWER

Dinamic White Control DWC
220/240V DWC 2700/6300K CRI>90
SIBYLLA S 24W 2800lm
SIBYLLA M 30W 3500lm
SIBYLLA L 36W 4200lm



Certification



CONCORDE

Design VillaTosca 2016



MONOLITE LUMINOSO

La *Ville Lumière* e una delle sue piazze più antiche e monumentali sono lo scenario a cui si ispira la lampada da terra CONCORDE. Affusolata e statuaria come un monolite, cilindrica e in metallo, cita l'obelisco della celebre piazza a pochi passi dagli eleganti Champs Elysées e ne rielabora la silhouette in una linea semplice e stilizzata.

La cornice cromata alla sommità e alla base dà una piacevole sensazione di leggerezza. CONCORDE trova il suo naturale completamento nel progetto VENDÔME, lampada da terra ispirata a un altro dei luoghi storici di Parigi.

BRIGHT MONOLITH

The *Ville Lumière* and one of its oldest and most monumental squares are the scenario that inspired the floor lamp CONCORDE. Slight and majestic as a monolith, cylindrical and made of metal, it reminds the famous obelisk of the square close to the elegant Champs Elysées, as a silhouette in a simple and stylised line.

The chrome frame at the top and base gives a pleasant feeling of lightness. CONCORDE finds its natural completion in VENDÔME, floor lamp inspired by another of the historical sites of Paris.

光るモノリス

輝く宮殿と最も古い広場の一つコンコルド広場、フローラーランプ『コンコルド』はそこにそびえ立つ記念碑にインスピレーションを得ました。まるでモノリスのような細い彫像は円筒の金属製であり、その姿はシャンゼリゼ通りの先にそびえ立つオベリスクを思わせます。

究極的に簡潔なシルエットを持ち、土台のある根元と、そこからスッと心地よく上部伸びた先にアクセントとなるクロム仕上げのリングが輝きます。『コンコルド』はやはりフランスの歴史的背景からインスピレーションを得た『ヴァンドーム』プロジェクトから派生したものです。



CONCORDE

Design VillaTosca 2016

Un monolite in metallo cilindrico di 179 cm di altezza. La cornice cromata della sua sommità e lo scuretto della base alleggeriscono e rendono piacevole la semplicità della forma. Luce diretta verso l'alto.

A cylindrical monolith in metal, height 179 cm. The chrome frame of his top and the shutter base lighten and make pleasant the simplicity of the form. Direct light upward.

高さ179cm、金属製円筒のモノリス。シンプルなフォルムの中に上部と下部2か所の クロムメッキのアクセントが心地よく同居します。光は本体上部からの直接光になります。

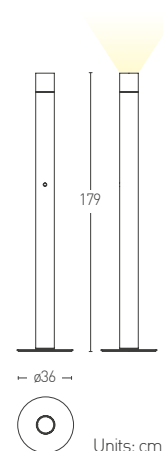

Finishes

- 103FT Black
 - 105FT White
- Details:
- 150 Chrome

Diffuser

PMMA methacrylate diffuser

Electronic driver

Dimmable included

Cable

Black fabric

Light source

LED

LED 50W
220/240V 4800lm 2700K CRI>90

A

Certification

CE EAC F IP20



VENDÔME

Design VillaTosca 2016



COLONNA DI LEGNO E METALLO

La lampada da terra VENDÔME è come un frammento dello skyline di Parigi, città delle luci per eccellenza. Allungata e monolitica, evoca in chiave stilizzata la colonna attorno a cui si apre una delle piazze più famose del mondo. E dalla raffinatezza di place VENDÔME, meta dello shopping e del lusso nel cuore elegante di Parigi, la lampada progettata da VillaTosca trae ispirazione per i materiali. Legno di rovere massello naturale e rovere massello tinto nero a poro aperto, caldo e prezioso, con dettagli metallici in bronzo e rame.

Il progetto VENDÔME trova il suo alter ego nella lampada da terra CONCORDE, ispirata a un altro dei luoghi simbolo parigini.

METAL AND WOOD COLUMN

VENDÔME floor lamp is like a fragment of the skyline of Paris, the city of lights for excellence. Lengthened, monolithic, this lamp evokes the column of one of the most famous squares in the world. By the sophistication of Place VENDÔME, fancy shopping destination in the elegant heart of Paris, the lamp designed by VillaTosca gets inspiration for materials. Natural solid oak wood or open-pore solid oak black stained, warm and unique, with metal details in bronze or copper.

Vendôme finds its alter ego in CONCORDE, floor lamp, inspired by another symbol place of Paris.

木と金属からなる柱

フロアランプ『ヴァンドーム』はパリの街の美しいスカイラインの光を切り取ったようなランプです。

細長いモノリスは世界でも有数の有名なヴァンドーム広場に収まる柱の様にも見えます。ヴァンドーム広場はパリの中でもとてもエレガントな高級ショッピングエリアの中央に位置し、VillaTosca Designはそこからインスピレーションを得て、素材を吟味いたしました。

温かみと高級感を醸し出す、天然の無垢オーク材はナチュラルカラーと黒色染め、金属部は真鍮と銅を使用しました。

フロアランプ『コンコルド』は『ヴァンドーム』同様、パリのシンボルに触発されて開発された姉妹品です。

VENDÔME

Design VillaTosca 2016

Un monolite cilindrico in legno e metallo dalle diverse finiture di 179 cm di altezza. Luce indiretta da atmosfera attraverso la striscia di luce verticale inserita lungo il fusto in legno e luce più potente posizionata nella sua sommità e rivolta verso l'alto rendono VENDÔME una lampada flessibile nell'uso e ricercata nelle soluzioni. La morbidezza e il colore del legno opposta alla durezza del metallo ne fanno un oggetto di arredo facilmente integrabile in molte tipologie stilistiche.

A cylindrical monolith of 179 cm in height in wood and metal by various finishes. The vertical light strip inserted along the wooden frame to create a warmer atmosphere and more powerful light positioned in its top facing upward make VENDÔME a flexible lamp in use and refined in the solutions. The softness and color of the wood opposite to the hardness of the metal make Vendome an object that can be easily integrated into many stylistic decor types.

高さ179cm、複数の金属と木材の融合による円筒のモノリス『ヴァンドーム』は木製フレームに内蔵された縦長の間接照明と本体上部から天井に向けて照射される強力な光のコンビネーションを持っており、様々な環境に対して柔軟に対応が可能です。

特徴的な柔らかな木の色の温もりとそれに相反する金属の融合を持つこのランプは様々なインテリアの中に調和しつつもその存在を主張することでしょう。

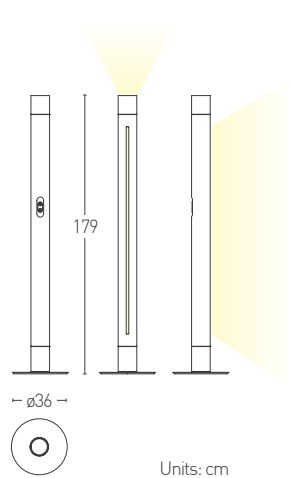

Finishes

- LR Solid oak
- 176 Bronzed brass
- LRN Solid oak stained black
- 177 Copper plated brass

Diffuser

PMMA methacrylate diffuser

Electronic driver

Dimmable included

Cable

Black fabric

Light source

LED

LED 220/240V

UP light indirect 50W

4800lm 2700K CRI>90

BASE light diffused 24W

2160lm 3000K CRI>90

A

Certification

CE EAC F IP20



ASTOLFO

Design Amedeo G. Cavalchini

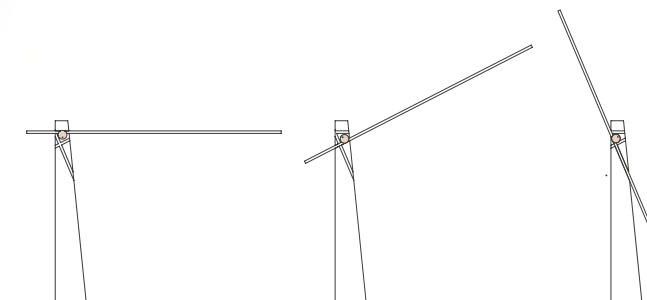

CAVALIERE LUMINOSO

L'epica cavalleresca offre lo spunto progettuale per la lampada da terra ASTOLFO, connubio tra la struttura ancestrale e rassicurante del legno e la tecnologia estrema della sorgente LED e del profilo minimale. Il suo design emula l'ordinato grafismo di una lancia luminosa, sottile e tecnologica, inserita meccanicamente in un fusto di legno massiccio attraversato da tagli netti e precisi, in cui la lancia può essere inserita secondo tre diversi angoli e orientamenti.

BRIGHT KNIGHT

The chivalrous epic inspires the floor lamp ASTOLFO, melting the ancestral and soothing structure of wood, the extreme technology of LED source and its minimal outline. Its design emulates the linear graphism of a light spear, thin and technological, mechanically inserted in a solid wood stem crossed by sharp and precise carves, where the light-spear can be placed in three different angles and orientations.

輝く騎士 (ナイト)

騎士の抒情詩が、このフロアーランプ「アストルフォ」のデザインの出発点となりました。不変とも言える天然木から作られた構造体を与える安心感に、ミニマルなラインで作られた最新技術のLED光源を融合させました。見た目にも特徴的なこの精悍な細く光る「テクノロジーの槍」とも言える発光部が、木製の台座に刻まれた溝の中に納まります。この溝によって3つの違う角度に向きが変えられます。

ASTOLFO

Design Amedeo G. Cavalchini

Lampada da terra con doppia sorgente luminosa LED. Costituita da una base in legno massello di rovere o noce nazionale e un'asta in alluminio anodizzato di colore nero. Le tre scanalature presenti nella parte superiore della base consentono all'asta di essere posizionata con tre differenti angoli rispetto alla base stessa, consentendo un approccio tattile e personale con la lampada.

Le sorgenti LED dimmerabili sono collocate lungo l'asta e nel retro della base consentendo un'illuminazione sia diretta che indiretta.

Floor lamp with double LED light sources. Solid oak or walnut base and arm in black anodized aluminium. Three carves on the top of the trunk allow to place the arm in three different angles giving the lamp a personal touch. The dimmable LED sources are along the arm and on the base back, creating both indirect and direct lighting.

二重のLED光源を持つフロアーランプ。ウォールナットまたはオークの無垢木材のベースにアルミ製ブラック・アルマイト仕上げのアーム。台座の上部に刻まれた溝は、アーム部分を三つの異なる角度に固定することができます。これによってこのランプは、見た目と空間と共に自由なアプローチを生み出す事が可能です。アーム部分とベースの背面に内蔵されたLED光源は、調光が可能で、直接照明と間接照明の二種類のあかりを同時に演出します。

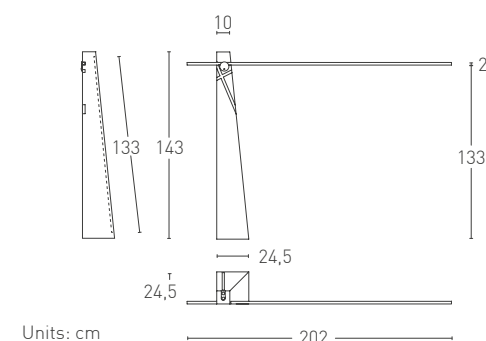

Finishes

- LN Walnut
- LR Oak

Diffuser

- 174 Black anodized aluminium

Cable

Black fabric

Electronic driver

Dimmable included

Light source

LED

Arm **LED** 36W 220/240V
3240lm 3000K CRI>90
Base **LED** 24W 220/240V
2160lm 3000K CRI>90

A

Certification



ASTOLFO HT

Design Amedeo G. Cavalchini

Lampada da terra con base realizzata in scatolato di acciaio verniciato e fronte in massello di rovere o noce. Le tre scanalature presenti nella parte superiore della base consentono all'asta luminosa - realizzata in alluminio anodizzato nero - di essere posizionata con tre differenti angoli rispetto alla base stessa, consentendo un approccio tattile e personale con la lampada.

La sorgente LED dimmerabile collocata nell'asta fornisce luce diretta o indiretta a seconda del posizionamento.

Floor lamp with folded sheet steel base and front cover in solid oak or walnut. Three carves on the top of the trunk allow to place the arm - with black anodized aluminum finish - in three different angles giving the lamp a personal touch.

The dimmable LED source placed along the arm gives direct or indirect light according to the different positioning.

スチール製ケースの台座にウォールナットまたはオークの無垢木材のファサード（表面）を使用したフロアランプ。台座の上部に刻まれた溝は、アーム部分を三つの異なる角度に固定することができます。これによってこのランプは、見た目と空間と共に自由なアプローチを生み出す事が可能です。

アーム部分は直接照明と間接照明の二種類のあかりを好みの配置によって選ぶことができます。

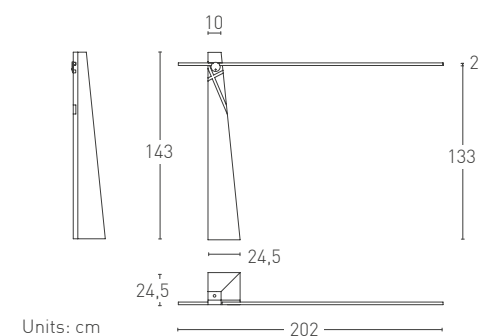

Finishes

- 115D FT Graphite grey + LR Oak
- 115D FT Graphite grey + LN Walnut

Diffuser

- 174 Black anodized aluminium

Cable

Black fabric

Electronic driver

Dimmable included

Light source

LED

LED 36W 220/240V
3240lm 3000K CRI>90



Certification

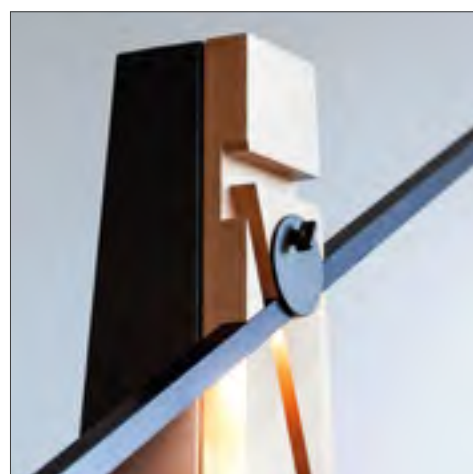

CORAL COLLECTION

Design VillaTosca

CORALLI BAROCCHI

CORAL, la serie che coniuga esteticamente lo stile barocco con le forme naturali dei coralli, offre diverse tipologie di prodotti a sospensione, a plafone e parete nelle misure "super" e "mini".

Icona della collezione, il candeliere a 8 luci declinato anche nella versione a 16 luci.

BAROQUE STYLE CORALS

CORAL, the collection which combines baroque style with the natural shapes of coral offers a selection of fittings designed for direct mounting on ceilings and walls or for suspended mounting. Available in two designated sizes "super" and "mini".

The core of the collection is a chandelier which is available in an eight or a sixteen lamp version.

バロックスタイルのサンゴ

「コーラル」は、バロックスタイルと自然の形を融合したデザインのシリーズです。シーリングタイプ、ウォールタイプのように直接設置可能なものから、シャンデリアタイプまで幅広く展開しています。このシリーズの中心は、8灯タイプと16灯タイプの二種類のシャンデリアで構成されています。他に「スーパー」と「ミニ」の2サイズが選べます。

CORAL / CORAL P

Design VillaTosca

CORAL è la versione a 8 luci che dà origine all'intera serie. Realizzata in metallo laccato, é disponibile nelle finiture: nero lucido, bianco lucido, verde chartreuse, rosso, foglia oro e foglia argento. Diffusori realizzati in vetro Pyrex serigrafato. Sorgenti alogene ECO Energy Saver (max 8x33W G9).

CORAL P, lampada a plafone a 6 luci. Realizzata in metallo laccato, é disponibile nelle finiture: nero lucido, bianco lucido, verde chartreuse, rosso, foglia oro e foglia argento. Diffusori realizzati in vetro Pyrex serigrafato. Sorgenti alogene ECO Energy Saver (max 6x33W G9).

CORAL is a 8 light chandelier that forms the basis of the collection. Made of lacquered metal, it is available in glossy black, glossy white, chartreuse green, red, gold foil and silver foil. The diffusers are made of etched Pyrex glass. Bulbs are halogen ECO Energy Saver (max 8x33W G9).

CORAL P, the ceiling lamp with 6 light. Made of lacquered metal, it is available in glossy black, glossy white, chartreuse green, red, gold foil and silver foil. The diffusers are made of etched Pyrex glass. Bulbs are halogen ECO Energy Saver (max 6x33W G9).

「コーラル」は8灯シャンデリアタイプで、このシリーズ全体の基本となっています。メタルの塗装仕上げで、ブラック光沢、ホワイト光沢、ライトグリーン、レッド、金箔、銀箔が選べます。セードはパイレックスにエッチング加工が施してあります。ランプには、エネルギーセーバーのエコハロゲン（最大6灯33ワットG9）が使用可能です。

「コーラル P」は、6灯式シーリングタイプのランプ。メタル製の本体は、以下の塗装から選択できます。ブラック光沢、ホワイト光沢、レッド、ライトグリーン、金箔仕上げ、銀箔仕上げ。セードは、パイレックスのエッチング仕上げ。ランプは、エコハロゲン・エナジーセーバー(最大6灯 33ワット G9)。

CORAL

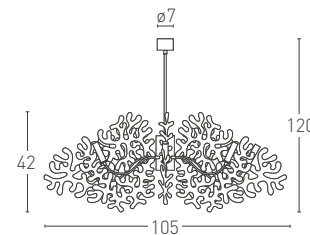

CORAL P

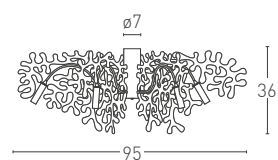

Units: cm

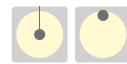

Finishes

- 112 Glossy black
- 114 Glossy white
- 119 Chartreuse green
- 120 Red
- 130 Gold foil
- 131 Silver foil

Diffuser

Etched Pyrex

Suggested light source

G9 Halogen ECO

CORAL max 8x33W

CORAL P max 6x33W

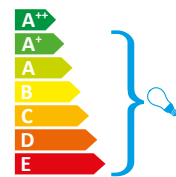

Certification



SUPERCORAL 8L/16L

Design VillaTosca

SUPERCORAL 8L e 16L, grande lampadario da 8 o 16 luci dal diametro di 140 cm. Realizzata in metallo laccato, é disponibile nelle finiture: nero lucido, bianco lucido, verde chartreuse, rosso, foglia oro e foglia argento. Diffusori realizzati in vetro Pyrex serigrafato. Sorgenti alogene ECO Energy Saver (max 8x48W G9/ max 16x33W G9).

SUPERCORAL 8L and 16L is a large chandelier (140 cm diameter). Made of lacquered metal, it is available in the following finishes: glossy black, glossy white, chartreuse green, red, gold foil and silver foil. The diffusers are made of etched Pyrex glass. Bulbs are halogen ECO Energy Saver (max 8x48W G9/ max 16x33W G9).

「スーパーコーラル8L/16L」は、8灯及び16灯の直径140cmのシャンデリアタイプの照明です。メタル製の本体の仕上げは、ブラック光沢、ホワイト光沢、ライトグリーン、レッド、金箔仕上げ、銀箔仕上げ。セードはパイレックスにエッチング加工が施してあります。ランプには、エネルギーセーバーのエコハロゲン(最大8灯48ワットG9 / 最大16灯33ワットG9)が使用可能です。

SUPERCORAL 8L

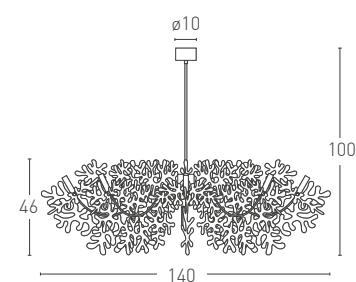

SUPERCORAL 16L

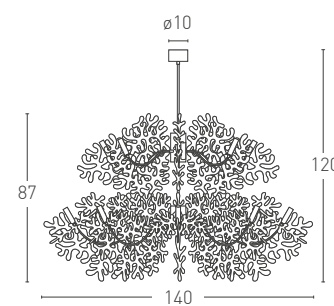

Units: cm

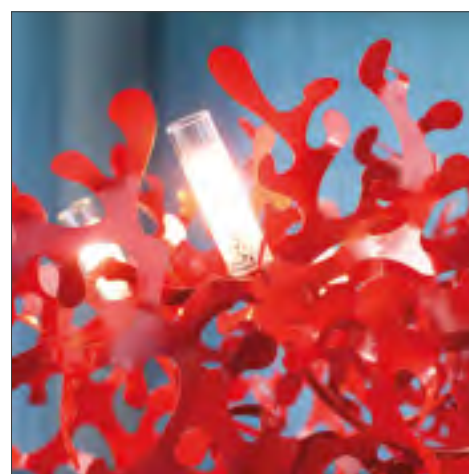
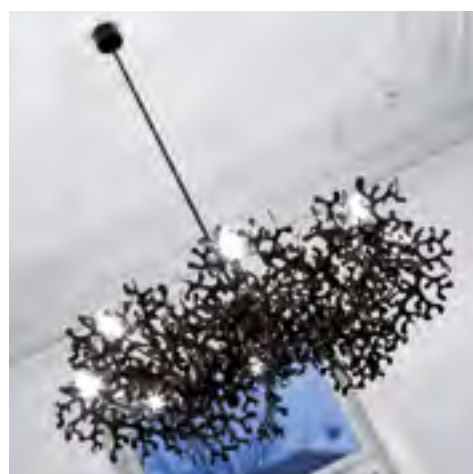

Finishes

- 112 Glossy black
- 114 Glossy white
- 119 Chartreuse green
- 120 Red
- 130 Gold foil
- 131 Silver foil

Diffuser

Etched Pyrex

Suggested light source

G9 Halogen ECO
 SUPERCORAL 8L max 8x48W
 SUPERCORAL 16L max 16x33W

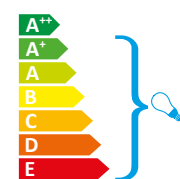

Certification



CORAL 21

Design VillaTosca

CORAL 21 è la versione applique della serie. Realizzata in metallo laccato, è disponibile nelle finiture: nero lucido, bianco lucido, verde chartreuse, rosso, foglia oro e foglia argento. Diffusori realizzati in vetro Pyrex serigrafato. Sorgenti alogene ECO Energy Saver (max 3x33W G9).

CORAL 21 is the wall lamp version of coral series. Made of lacquered metal, it is available in glossy black, glossy white, chartreuse green, red, gold foil and silver foil. The diffusers are made of etched Pyrex glass. Bulbs are halogen ECO Energy Saver (max 3x33 W G9).

「コーラル 21」は、同シリーズのウォールタイプ。メタル製の本体は、以下の塗装から選択できます。ブラック光沢、ホワイト光沢、レッド、ライトグリーン、金箔仕上げ、銀箔仕上げ。セードは、バイレックスのエッチング仕上げ。ランプは、エコハロゲン・エナジーセーバー(最大3灯33ワットG9)。



Finishes

- 112 Glossy black
- 114 Glossy white
- 119 Chartreuse green
- 120 Red
- 130 Gold foil
- 131 Silver foil

Diffuser

Etched Pyrex

Suggested light source



G9 Halogen ECO
max 3x33W

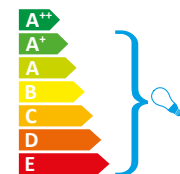

Certification

CE EAC PS E F Classe I IP20



CORAL 21

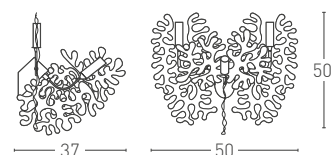

Units: cm

MINICORAL S/A/P

Design VillaTosca

MINICORAL è una serie di piccoli punti luce a sospensione, a parete e plafone realizzati in metallo laccato e disponibili nelle finiture: nero lucido, bianco lucido, verde chartreuse, rosso, foglia oro e foglia argento. Diffusori realizzati in vetro Pyrex serigrafato. Sorgenti alogene ECO Energy Saver (max 1x48W G9).

MINICORAL is a collection of small spot lights, in suspension, ceiling and wall lamp version. Made of lacquered metal it is available in glossy black, glossy white, chartreuse green, red, gold foil and silver foil. The diffusers are made of etched Pyrex glass. Bulbs are halogen ECO Energy Saver (max 1x48W G9).

「ミニコーラル」は、シャンデリア、シーリング、ウォールタイプが揃った小さなスポット照明コレクション。メタルの塗装仕上げで、ブラック光沢、ホワイト光沢、ライトグリーン、レッド、金箔、銀箔が選べます。セードは、パイレックスのエッチング仕上げ。ランプには、エネルギーセーバーのエコハロゲン(最大1灯48ワットG9)が使用可能です。



Finishes

- 112 Glossy black
- 114 Glossy white
- 119 Chartreuse green
- 120 Red
- 130 Gold foil
- 131 Silver foil

Diffuser

Etched Pyrex

Cable

Transparent

Suggested light source

 G9 Halogen ECO
max 1x48W

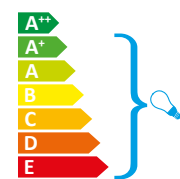

Certification

 Classe I IP20

MINICORAL S

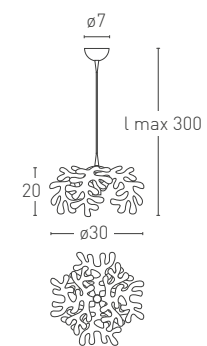

MINICORAL A

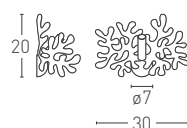

MINICORAL P

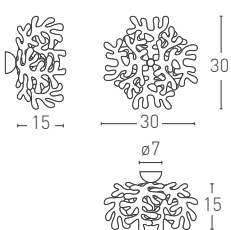

Units: cm

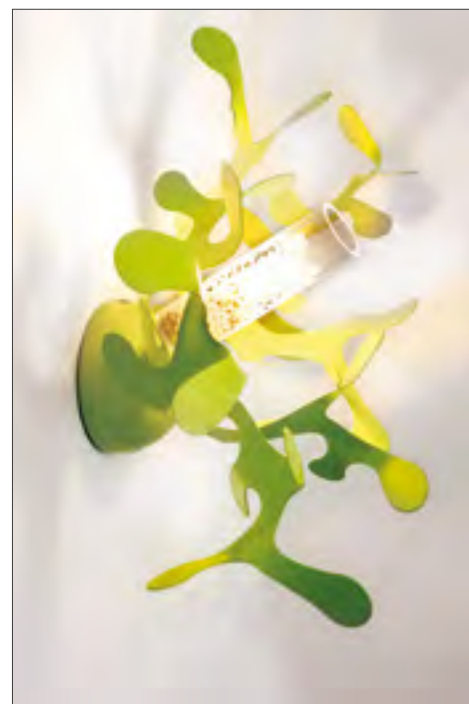

FLAT COLLECTION

Design VillaTosca



UN SOTTILE STRATO DI LUCE

FLAT è il nuovo sistema di illuminazione disegnato da VillaTosca per LUMEN CENTER ITALIA. Il progetto condensa al minimo la superficie del corpo lampada con notevoli vantaggi in termini di leggerezza e riduzione degli ingombri.

Le sorgenti LED utilizzate forniscono luce diretta verso il basso mentre lo strato di metacrilato la diffonde in maniera diffusa nell'ambiente.

A THIN LAYER OF LIGHT

FLAT is the new lighting system designed by VillaTosca for LUMEN CENTER ITALIA. The project condenses to a minimum the surface of the lamp body with considerable advantages in terms of lightness and space reduction.

The LED light sources used provide direct light downwards while the layer of methacrylate spreads diffusely into the environment.

薄い光のレイヤー

「フラット」は、ヴィットラトスカによってデザインされたルーメンセンター・イタリアの新しい照明システムです。この製品は、ライト本体の表面を最小限に抑え、大幅な軽量化と省スペースを実現しています。LED光源による下方向への直接照明のほか、メタクリル樹脂層によって光が拡散して空間に溶け込む間接照明を生み出します。

FLAT 04/05/06

Design VillaTosca



Finishes

- 105FT White
- 130 Gold foil
- 131 Silver foil
- 132 Copper foil
- 172 Natural anodized aluminium

Diffuser

Lenticular PC

Cable

Transparent

Electronic driver

Dimmable included PUSH, 1...10
Dimmable included TRIAC cut-phase

Light source LED

FLAT 04: LED 25,2W

PUSH, 1...10:

110/240V 2250lm 2700K CRI>90

110/240V 2500lm 3000K CRI>90

TRIAC:

220/240V 2250lm 2700K CRI>90

FLAT 05: LED 31,5W

PUSH, 1...10:

110/240V 2850lm 2700K CRI>90

110/240V 3150lm 3000K CRI>90

TRIAC:

220/240V 2850lm 2700K CRI>90

FLAT 06: LED 37,8W

PUSH, 1...10:

110/240V 3420lm 2700K CRI>90

110/240V 3800lm 3000K CRI>90

TRIAC:

220/240V 3420lm 2700K CRI>90

A

Certification

CE EAC PS E F Classe I IP20

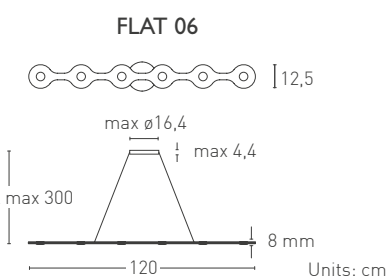
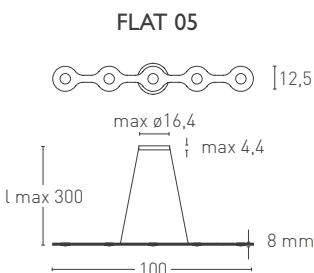
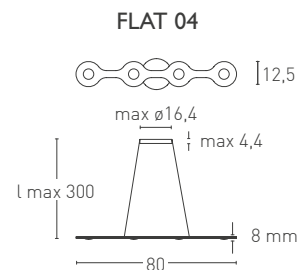

Collezione di sottili sospensioni a 4, 5 o 6 punti luce disposti linearmente. La struttura, realizzata da due lamine di alluminio anodizzato naturale frapposti da uno strato di metacrilato trasparente, fornisce luce indiretta verso l'alto e luce diretta verso il basso diffusa attraverso diffusori lenticolari in policarbonato. Alimentatore dimmerabile alloggiato nel rosone. Cavi di alimentazione e sospensione trasparenti.

Collection of thin suspensions with 4, 5, or 6 LED linear light sources. The structure is composed of three thin sheets, externally natural anodized aluminium and internally methacrylate, which provides direct light downward through lenticular polycarbonate diffusers, while the methacrylate layer spreads diffusely light in the surrounding. Dimmable power supply located in the ceiling rose. Transparent power and suspension cables.

直線上に並んだ4, 5, 6灯を備えた薄型のペンダントランプシリーズ。この構造体はアルマイト処理された二枚のアルミによって透明メタクリルを挟む構造になっています。ポリカーボネート製レンズディフューザーによって上向きに間接照明、下向きに直接照明を拡散することができます。フランジカバー内には調光機能内蔵ドライバーが設置されています。電源ケーブルを兼ねた吊り下げワイヤーには細く柔軟性の高い素材を使用しました。



FLAT RING 3/6/12

Design VillaTosca

Collezione di sottili sospensioni a 3, 6 o 12 punti luce disposti in circolo. La struttura, realizzata da due lamine di alluminio anodizzato naturale frapposti da uno strato di metacrilato trasparente, fornisce luce indiretta verso l'alto e luce diretta verso il basso attraverso diffusori lenticolari in policarbonato. Alimentatore dimmerabile alloggiato nel rosone. Cavi di alimentazione e sospensione trasparenti.

Collection of thin circular suspensions with 3, 6, or 12 LED light sources. The structure is composed of three thin sheets, externally natural anodized aluminium and internally methacrylate, which provides direct light downward through lenticular polycarbonate diffusers, while the methacrylate layer spreads diffusely light in the surrounding. Dimmable power supply housed in the ceiling rose. Transparent power and suspension cables. v

リング状に3、6、12灯を備えた薄型のペンダントランプシリーズ。この構造体はアルマイト処理された二枚のアルミによって透明メタクリルを挟む構造になっています。ポリカーボネート製レンズディフューザーによって上向きに間接照明、下向きに直接照明を拡散することができます。フランジカバー内には調光機能内蔵ドライバーが設置されています。電源ケーブルを兼ねた吊り下げワイヤーには細く柔軟性の高い素材を使用しました。

FLAT RING 3

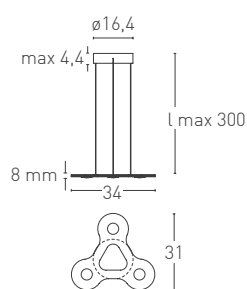

FLAT RING 6

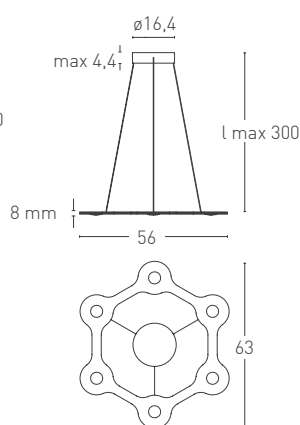

FLAT RING 12

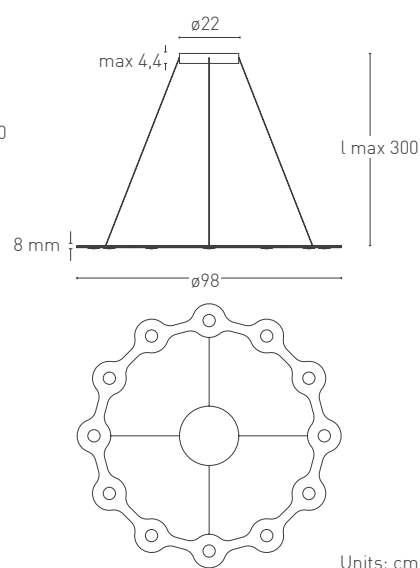

Units: cm



Finishes

- 105FT White
- 130 Gold foil
- 131 Silver foil
- 132 Copper foil
- 172 Natural anodized aluminium

Diffuser

Lenticular PC

Cable

Transparent

Electronic driver

Dimmable included PUSH, 1...10
Dimmable included TRIAC cut-phase

Light source LED

FLAT RING 3: LED 18,9W
PUSH, 1...10:
110/240V 1890lm 3000K CRI>90
TRIAC:
220/240V 1700lm 2700K CRI>90

FLAT RING 6: LED 37,8W
PUSH, 1...10:
110/240V 3800lm 3000K CRI>90
TRIAC:
220/240V 3420lm 2700K CRI>90

FLAT RING 12: LED 75,6W
PUSH, 1...10:
110/240V 7560lm 3000K CRI>90
TRIAC:
220/240V 6800lm 2700K CRI>90

A

Certification

CE EAC PS E F Classe I IP20



FLAT SATURN 1/2/3

Design VillaTosca

FLAT SATURN è un sistema di illuminazione che combina i modelli RING3, RING6, RING12 in un'unica sospensione. La lampada è disponibile nelle versioni a due elementi R3+R6, R6+R12 e nel modello a tre costruito combinando R3+R6+R12.

Alimentatore dimmerabile alloggiato nel rosone. Cavi di alimentazione e sospensione trasparenti.

FLAT SATURN is a lighting system which combines RING3, RING6, RING12 in one suspension. It's available in two rings versions: R3+R6 and R6+R12; and also in three rings version combining R3+R6+R12. Dimmable power supply located in the ceiling rose.

Transparent power and suspension cables.

「フラット・サトゥーン」は「フラット・リング3」、「フラット・リング6」、「フラット・リング12」を一つのペンダントランプとして組み合わせたシステムです。二つのエレメントを組み合わせたタイプ「R3+R6」、「R6+R12」と三つのエレメント全てを組み合わせた「R3+R6+R12」の三種類を用意しました。フランジカバー内には調光機能内蔵ドライバーが設置されています。電源ケーブルを兼ねた吊り下げワイヤーには細く柔軟性の高い素材を使用しました。

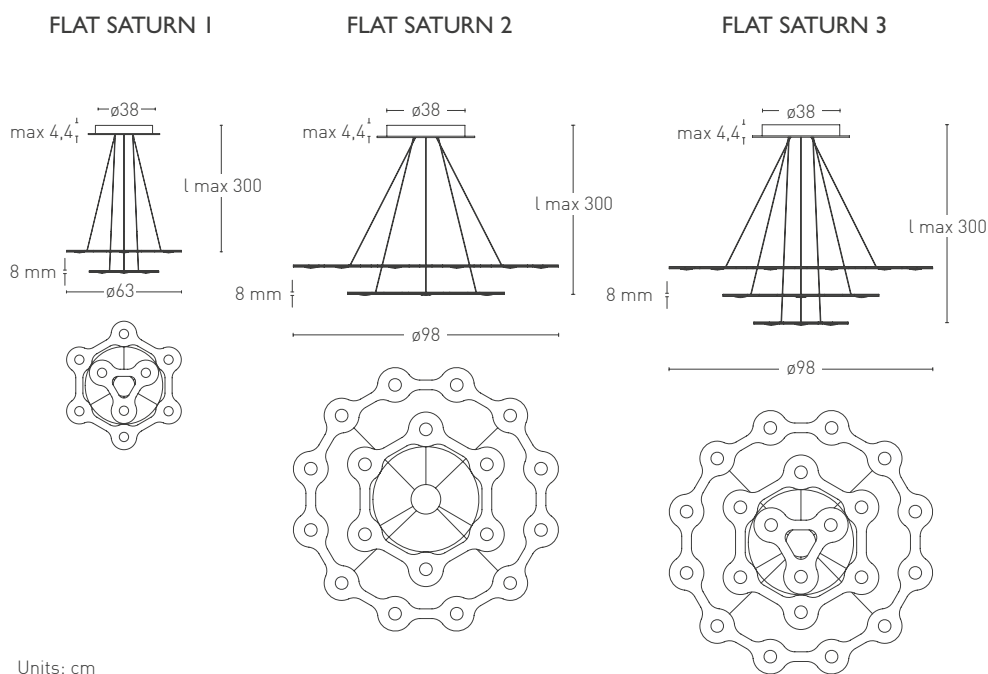

Units: cm



Finishes

- 105FT White
- 130 Gold foil
- 131 Silver foil
- 132 Copper foil
- 172 Natural anodized aluminium

Diffuser

Lenticular PC

Cable

Transparent

Electronic Driver

Dimmable included PUSH, 1...10
Dimmable included TRIAC cut-phase

Light source LED

FLAT SATURN 1: LED 56,7W
PUSH, 1...10:
110/240V 5670lm 3000K CRI>90
TRIAC:
220/240V 5100lm 2700K CRI>90

FLAT SATURN 2: LED 113,4W
PUSH, 1...10:
110/240V 11300lm 3000K CRI>90
TRIAC:
220/240V 10170lm 2700K CRI>90

FLAT SATURN 3: LED 132,3W
PUSH, 1...10:
110/240V 13230lm 3000K CRI>90
TRIAC:
220/240V 11900lm 2700K CRI>90



Certification

CE EAC PS E F Classe I IP20



FOLIAGE

Design Enrico Azzimonti



EMOZIONI LUMINOSE

FOLIAGE è la famiglia di lampade a sorgente LED disegnata da Enrico Azzimonti per LUMEN CENTER ITALIA. Il progetto si propone di riportare attraverso linee essenziali e giochi di luce indiretta le emozioni luminose che si provano standosene sdraiati sotto la chioma di un albero e osservandone le foglie.

BRIGHT EMOTIONS

Foliage is a LED light source family designed by Enrico Azzimonti for LUMEN CENTER ITALIA. The project aims to restore, through essential lines and games of indirect light, the same bright emotions felt lying under a tree foliage and watching its leaves.

光のエモーション

「フォリアージュ」はルーメンセンター・イタリアのためにエンリーコ・アズィモンティによってデザインされたLED光源を内蔵したランプのシリーズ。この優雅なラインでデザインされたランプは、樹木の下に横たわって木漏れ日を見上げた時に現れるような光の再現を目指して作られました。

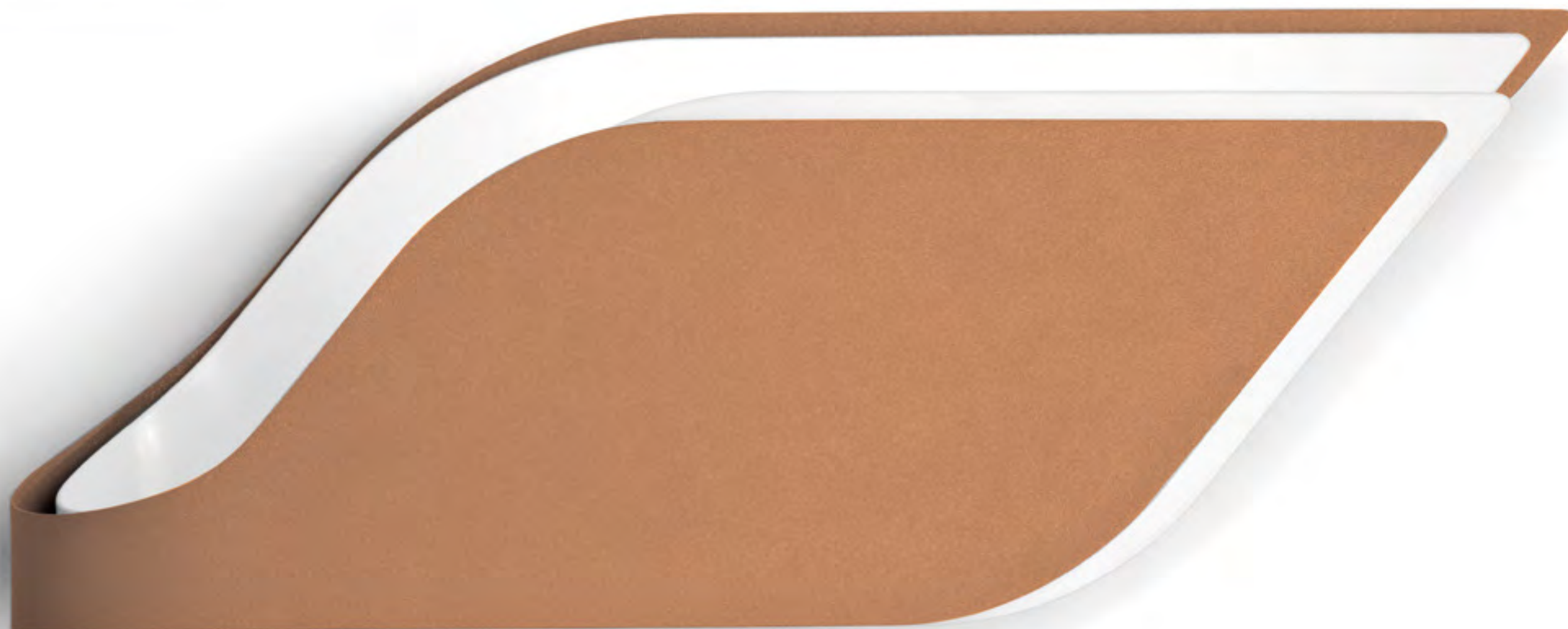

FOLIAGE / FOLIAGE P

Design Enrico Azzimonti

FOLIAGE, applique e plafoniera a sorgente LED disegnata da Enrico Azzimonti per LUMEN CENTER ITALIA. È presentata in due misure combinabili a parete o soffitto.

Disponibile nelle finiture bianco fine textured/bianco opaco, grigio sabbia fine textured/bianco opaco, oxyde fine textured/bianco opaco e emerald fine textured/bianco opaco. Sorgente luminosa LED da 2x6W 1200lm per la versione P da 38 cm e 4x6W 2400lm per la versione da 56 cm.

FOLIAGE, wall and ceiling lamps with LED light sources designed by Enrico Azzimonti for LUMEN CENTER ITALIA. Available in two sizes combinable as wall or ceiling lamps.

Available colour combinations: fine textured white/matt white, fine textured sand grey/matt white, fine textured oxyde/matt white, fine textured emerald/matt white.

LED light source 2x6W 1200lm for the P version (38 cm) and 4x6W 2400lm for the 56 cm version.

「フォリアージュ」シリーズのウォール/シーリングランプ。ルーメンセンター・イタリアのためにエンリコ・アッツイモンティによってデザインされたLED光源ランプ。二種類のサイズでウォール/シーリングの両方に使用が可能です。塗装のコンビネーションは、梨地状のファインテクスチャー（以下FT）FTホワイト/ホワイト半光沢、FTサンド・グレー/ホワイト半光沢、FTオレンジ/ホワイト半光沢、FTエメラルド/ホワイト半光沢の4種類から選択できます。LED光源は2x6ワット、1200ルーメンが「フォリアージュP」のバージョンに、4x6ワット、2400ルーメンが「フォリアージュ」56cmのバージョンに内蔵されています。



FOLIAGE

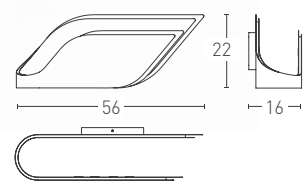

FOLIAGE P

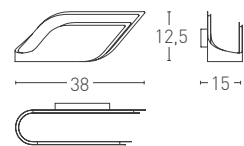

Units: cm

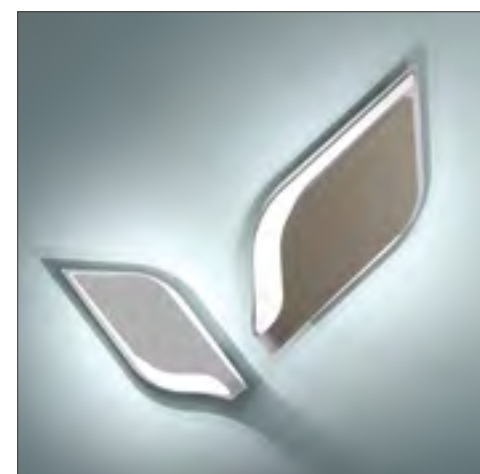

Finishes

- Fine textured White and Matt white
○ ○ 105FT + 106
- Fine textured Sand grey and Matt white
● ○ 115R FT + 106
- Fine textured Emerald and Matt white
● ○ 116FT + 106
- Fine textured Oxyde and Matt white
● ○ 117FT + 106

Electronic driver

Dimmable included TRIAC

Light source

LED

FOLIAGE

LED TOTAL POWER 24W 220/240V
2400lm 3000K CRI>90

FOLIAGE P

LED TOTAL POWER 12W 220/240V
1200lm 3000K CRI>90

A

Certification

CE EAC F Classe I IP20



FREEDOM

Design Enrico Azzimonti

LA LUCE CHE LIBERA EMOZIONI E SENSAZIONI

Ispirata dalla percezione di circolarità della luce generata dalla fiamma di una candela in cui forma, colore, luce e calore sembrano essere magicamente racchiusi su loro stessi per poi aprirsi rischiarendo il buio e donando benessere, nasce FREEDOM - design Enrico Azzimonti - una rivisitazione contemporanea del candeliere.

THE LIGHT THAT LETS EMOTIONS AND SENSATIONS BE FREE

Inspired by light circularity perception created by a candle flame where shape, color, light and heat seem to be magically enclosed in themselves waiting to be opened, enlightening and giving wellness, arise FREEDOM - design Enrico Azzimonti - a contemporary re-edition of the chandelier.

感情と感覚を開放するあかり

キャンドルの炎によって円形に拡散するあかりが生まれるフォルム、カラー、光、暖かさのそれらの感覚からインスピレーションを受け、この感覚の特徴を魅惑的に封じ込み、闇を照らしながらもその快適さを与えるそんな発想から「フリーダム」は生まれました。エンリーコ・アズィモンティのデザインによる現代版のシャンデリア・デザインを目指した、ペンダントタイプのランプです。

FREEDOM 10L/16L

Design Enrico Azzimonti



FREEDOM lampadario a sospensione disegnato da Enrico Azzimonti per LUMEN CENTER ITALIA. Caratterizzato dalla semplicità delle linee, è disponibile nelle versioni a 10 o 16 luci. Finiture disponibili: nichel nero e bianco opaco.

FREEDOM chandelier designed by Enrico Azzimonti for LUMEN CENTER ITALIA. Characterized by the simplicity of the lines, the lamp is available with 10 or 16 lights. Finishes available: black nickel and matt white.

「フリーダム」は、ルーメンセンター・イタリアのためにエンリーコ・アッツイモンティによってデザインされたシャンデリアタイプのランプ。シンプルなラインが特徴です。このシャンデリアは、10灯、16灯の二種類が用意されています。塗装はニッケル・ブラックとホワイト半光沢の二種類が用意されています。



FREEDOM 10L

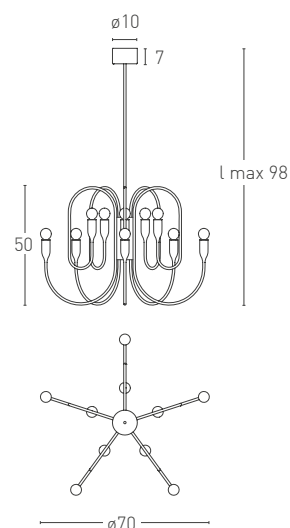

FREEDOM 16L

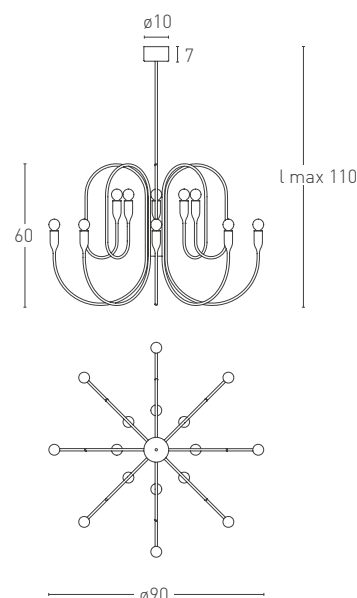

Units: cm

Finishes

- 106 Matt white
- 157 Black nickel

Suggested light source

- E14 Halogen ECO
- FREEDOM 10L max 10x46W
- FREEDOM 16L max 16x46W
- E14 LED

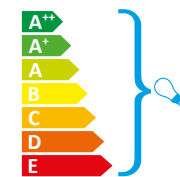

Certification

CE EAC Classe I IP20



GRUS

Design Alberto Saggia+Valerio Sommella



UNA GRU DI LUCE

GRUS metafora geometrica degli eleganti volatili dalle lunghe zampe e di una piccola costellazione, la cui conformazione ricorda proprio la figura di una "gru" pronta a spiccare il volo, la nuova lampada da terra disegnata da Alberto Saggia e Valerio Sommella per LUMEN CENTER ITALIA.

A CRANE OF LIGHT

GRUS geometric metaphor of elegant birds with long paws and also of the homonym small constellation - named in latin Grus - whose stars seems to draw a crane ready to take off. This is the concept behind the new floor lamp designed by Alberto Saggia e Valerio Sommella for LUMEN CENTER ITALIA.

光のクレーン

長い脚を持つ優雅な鳥「鶴」の幾何学的な隠喩とその姿を象った星座の「ツル座」。この空に飛び立つ「鶴」を思わせる「グルース」は、ルーメンセンター・イタリアのためにアルベルト・サッジャとヴァレリオ・ソッメッラによってデザインされた新しいフロアーランプ。

GRUS

Design Alberto Saggia+Valerio Sommella

Lampada da terra con punto luce decentrato caratterizzata da un'esile struttura geometrica realizzata in lamiera verniciata e disponibile nelle finiture grigio grafite o grigio perla. La struttura portante è divisa in due parti - una imperniata sull'altra - tenute in tensione da un cavo metallico che scorre parallelo alla struttura e fissato alla base romboidale. La regolazione della tensione del cavo consente la regolazione in altezza del grande diffusore in tessuto che nasconde la sorgente luminosa. Diffusore disponibile nelle finiture white, red wine, cognac e sage.

Floor lamp with decentralized lighting spot and with a thin geometric structure finely realized in aluminium sheet and available in graphite grey or pearl grey finishes. The framework is composed of two parts, one pivoted on the other, fixed by a metal adjustable wire along the structure and set on the metal rhomboidal base. The adjustment of the metal wire allows height regulation of the large textile diffuser that hides the light source. Diffuser available in four colors: white, red wine, cognac and sage.

薄いスチールパネルによって幾何学的に構成されたアームを持つフロアーランプ。グラファイト・グレーとパール・グレーの二種類の塗装が用意されています。ヒンジ結合で重ね合わせた二つのパーツの構造体を平行の吊りワイヤーを介してひし形の台座に固定します。この吊りワイヤーの長さを調整することによって光源を内蔵した布製の大きなセードの高さを調節が可能です。セードのカラーは、ホワイト、レッドワイン、コニャック、ホワイトセージの4種類が用意されています。

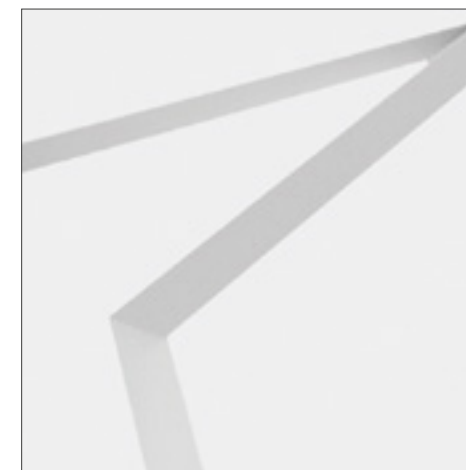
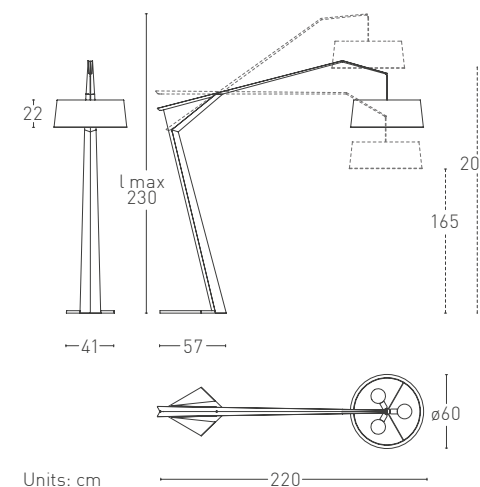

Finishes

- 115D FT Graphite grey
- 123 Pearl grey

Diffuser

- BC White
- C Cognac
- R Red wine
- W Sage

Cable

Transparent

Dimmer

Included

Suggested light source

E27 Halogen ECO
max 3x77W

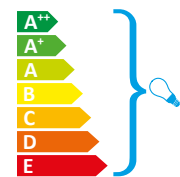

Certification





ALBA E TRAMONTO IN UNA NUOVA APPLIQUE

HINODE, applique a luce indiretta disegnata da Setsu&Shinobu Ito per LUMEN CENTER ITALIA. La lampada, liberamente ispirata alla luce del giorno che sorge e tramonta sulla linea dell'orizzonte, illumina generosamente verso l'alto e diffonde, attraverso una fessura nel corpo lampada, una morbida luce verso il basso.

SUNSHINE AND SUNSET IN A NEW WALL LAMP

HINODE an indirect light wall lamp designed by Setsu&Shinobu Ito for LUMEN CENTER ITALIA. The lamp, inspired by the daylight that rises and sets on the horizon line, lights generously upwards and spreads a soft light downwards through a slot in the lamp structure.

日の出と夕暮れを 新しいウォールランプに

「日の出」は、ルーメンセンター・イタリアのため伊藤節と伊藤しのぶによってデザインされたウォールタイプの間接照明です。地平線から日が昇り、そして日が沈む様子をイメージして製作されました。光が惜しみなく上向きに放射されるとともに、ランプ構造の隙間からやわらかく下方に広がります。

HINODE

Design Setsu&Shinobu Ito

HINODE, applique in alluminio pressofuso con sorgente LED o alogena ECO Energy Saver, disegnata da Setsu&Shinobu Ito per LUMEN CENTER ITALIA. Disponibile nelle finiture: bianco opaco, alluminio sabbiato e grigio perla.

HINODE is a wall lamp in die cast aluminium with LED or ECO halogen light source, designed by Setsu&Shinobu Ito for LUMEN CENTER ITALIA. Available in the following finishes: matt white, sandblasted aluminium or pearl grey.

「日の出」はアルミダイキャスト成型のLEDまたはエナジーセーバー・エコハロゲンのウォールタイプのランプ。ルーメンセンター・イタリアのため伊藤節+伊藤しのぶがデザインしたランプ。ホワイト半光沢、アルミ・サンドブラスト仕上げ、パール・グレイの塗装から選択できます。

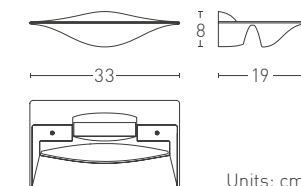
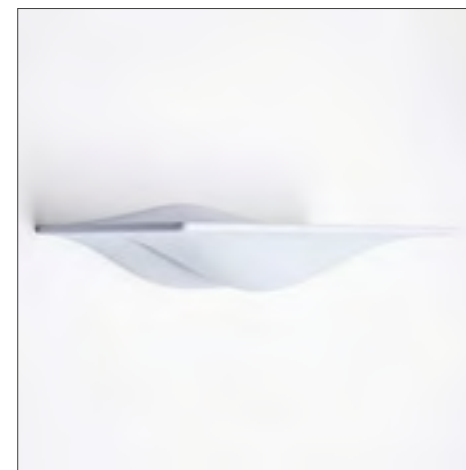

Units: cm

Finishes

- 106 Matt white
- 121 Sandblasted aluminium
- 123 Pearl grey

Electronic driver

HINODE LED Dimmable included TRIAC

Suggested light source

HINODE 
R7s Linear Halogen ECO 114,2 mm
max 1x230W

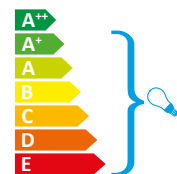

Light source

LED

HINODE LED
LED TOTAL POWER 42W 220/240V
3850lm 3000K CRI>90



Certification

HINODE
    Classe I IP20

HINODE LED
   Classe I IP20



ICEGLOBE COLLECTION

Design VillaTosca

LUCE ARTICA

ICEGLOBE è l'iconica collezione di lampade a sospensione, plafoniera, applique, terra e tavolo realizzate in polycarbonato microforato con la tecnologia dello stampaggio rotazionale.

La collezione, che dal 2005 è uno tra i prodotti best seller, è declinata in innumerevoli versioni realizzate con sfere dal diametro differente: la famiglia ICEGLOBE include sfere con diametro di cm: 30, 45, 57, 78; la famiglia MINI sfere con diametro 20 cm e la famiglia MICRO sfere dal diametro 12 cm.

ARTIC LIGHT

ICEGLOBE is the iconic collection of suspension, ceiling, wall, floor and table lamps made of micropunched polycarbonate by rotational molding technology. The collection, that represents one of the "best sellers" products since 2005, is available in numerous versions made of spheres with different diameters: the ICEGLOBE family includes spheres with diameters of 30, 45, 57, 78 cm; the MINI family includes spheres with diameter of 20 cm while the MICRO family includes spheres with diameter of 12 cm.

北極からのひかり

「アイスグローブ」は、ペンダントタイプ、シーリングタイプ、ウォールタイプ、フロアタイプ、テーブルタイプで提供している、ヴィットラトスカを代表する照明コレクションです。耐熱性ポリカーボネートを回転成形して作った本体から無数の孔を通して光が射します。本コレクションは、2005年から続くベストセラー商品の一つとしてさまざまなタイプとサイズを展開。「アイスグローブ」シリーズには、直径30センチ、45センチ、57センチ、78センチがあります。「ミニ」シリーズは直径20センチ、「マイクロ」シリーズは直径12センチとなります。

ICEGLOBE S/LS/MAXI S/GIANT S

Design VillaTosca

ICEGLOBE nelle versioni a sospensione da 30, 45, 57 e 78 cm. Diffusore realizzato in policarbonato microforato autoestinguente, rosone con finitura nichel satinato. Possibilità di attacco a soffitto decentrato rispetto al rosone per i modelli: IG S, IG LS, IG MAXI S.

ICEGLOBE line for suspension lamps of 30, 45, 57 and 78 cm. Diffuser made of self-extinguishing micropunched polycarbonate, ceiling rose with a satin nickel finish. It may be mounted on the ceiling off centre with respect to the ceiling rose for the models: IG S, IG LS, IG MAXI S.

ペンダントタイプのアイスグローブ・シリーズで直径30、45、57、78 cmの四つのサイズ。グローブは、自己消化性を持つポリカーボネート製。フランジは、ニッケル・サテン仕上げ。「IG S」、「IG LS」、「IG MAXI S」は、ランプをフランジとは別の位置に設置することも可能。

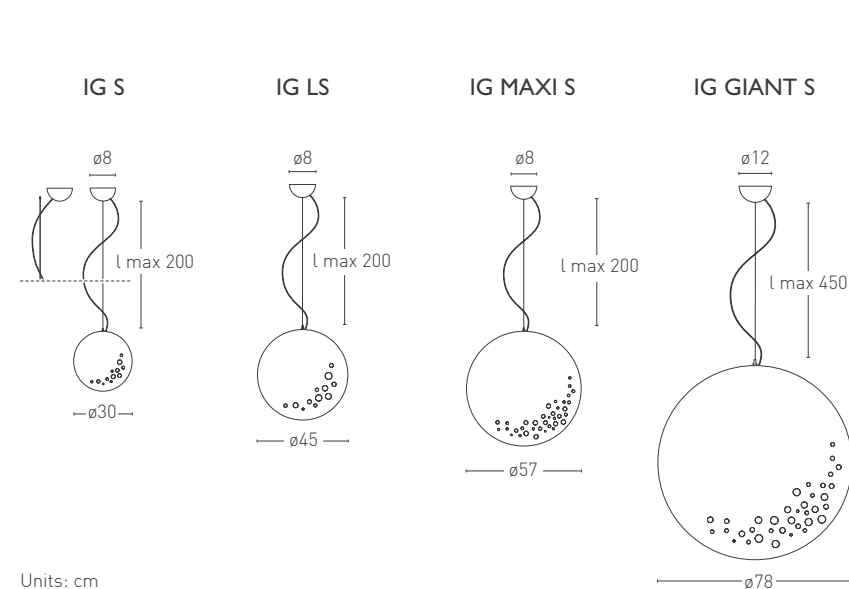

Units: cm



Finishes

● 166 Satin nickel

Diffuser

PC Polycarbonate

Cable

Transparent

Suggested light source

E27 ECO Fluo
max 1x24W

E27 Halogen ECO

ICEGLOBE S max 1x77W

ICEGLOBE LS / MAXI S max 1x116W

ICEGLOBE GIANT S max 1x205W

GX24q-4 ECO Fluo

ICEGLOBE GIANT S max 2x42W

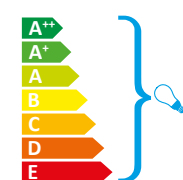

Certification

CE EAC PS E F Classe I IP20



ICEGLOBE SEMI MAXI / SEMI GIANT

Design VillaTosca

ICEGLOBE nelle versioni a semisfera a sospensione da 57 o 78 cm di diametro. Diffusore realizzato in policarbonato microforato autoestinguente, rosone con finitura nichel satinato. Possibilità di attacco a soffitto decentrato rispetto al rosone per il modello IG SEMI MAXI.

ICEGLOBE in the half-sphere suspension models with a diameter of 57 or 78 cm. Diffuser made of self-extinguishing micropunched polycarbonate, supplied with ceiling rose with a satin nickel finish. It may be mounted on the ceiling off centre with respect to the ceiling rose for IG SEMI MAXI only.

アイスグローブの半球体セードのバージョン。直径57と78cmのサイズで構成されています。グローブは、自己消化性を持つポリカーボネート製。フランジは、ニッケル・サテン仕上げ。「IG MAXI SEMI」は、ランプをフランジとは別の位置に設置することも可能。



Finishes

- 166 Satin nickel

Diffuser

PC Polycarbonate

Cable

Transparent

Suggested light source

- E27 Halogen ECO
ICEGLOBE SEMI MAXI max 1x116W
ICEGLOBE SEMI GIANT max 3x116W
- E27 ECO Fluo
ICEGLOBE SEMI MAXI max 1x24W
ICEGLOBE SEMI GIANT max 3x24W

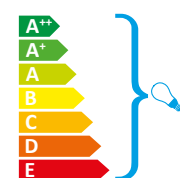

Certification

CE EAC PS E F Classe I IP20

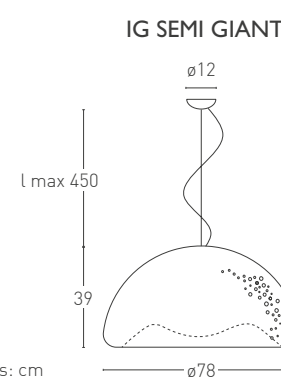
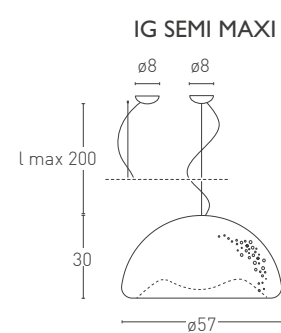

Units: cm

ICEGLOBE 2I/2IL

Design VillaTosca

ICEGLOBE nelle versioni da parete e plafone con diametro 30 o 45 cm. Diffusore realizzato in policarbonato microforato autoestinguente, attacco a muro con finitura nichel satinato.

ICEGLOBE in the wall and in the ceiling versions with a diameter of 30 cm and 45 cm. Diffuser made of self-extinguishing micropunched polycarbonate, wall holder with a satin nickel finish.

アイスグローブのウォール/シーリングタイプ。グローブの直径は30cmと45cm。グローブは、ポリカーボネート(自己消化性素材)製。取り付けベースは、ニッケルサテン仕上げのメタル製。

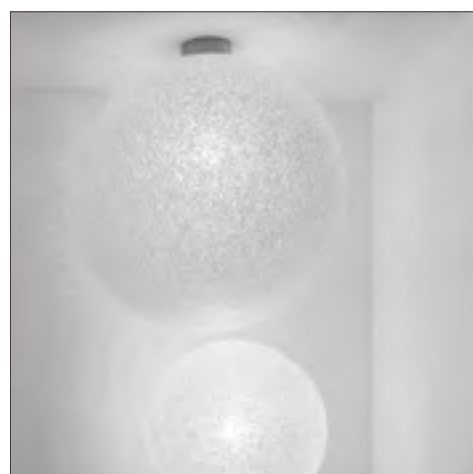

IG 2I

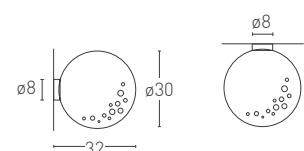

IG 2IL

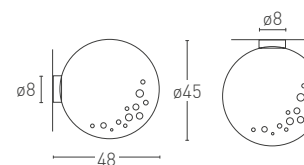

Units: cm



Finishes

● 166 Satin nickel

Diffuser

PC Polycarbonate

Cable

Transparent

Suggested light source

 E27 ECO Fluo
max 1x24W

 E27 Halogen ECO

ICEGLOBE 2I max 1x77W

ICEGLOBE 2IL max 1x116W

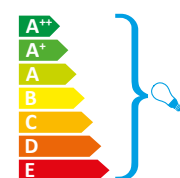

Certification

    Classe I IP20

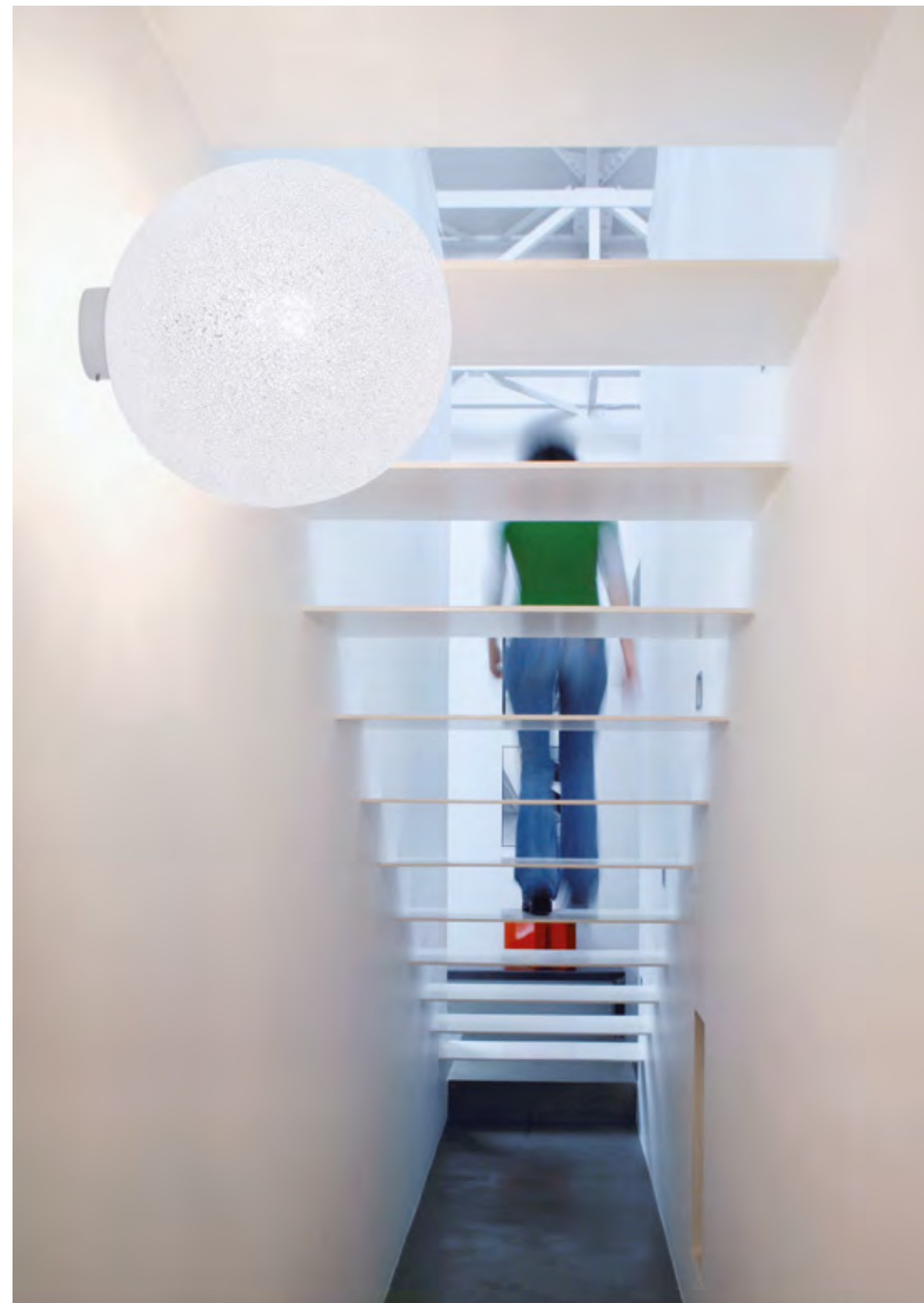

ICEGLOBE 9/10/11/12

Design VillaTosca

ICEGLOBE da terra con sfera da 30 cm. Stelo disponibile in 4 diverse altezze. Diffusore realizzato in policarbonato microforato autoestinguente. Stelo e base realizzati in metallo con finitura nichel satinato. Regolatore di intensità luminosa incluso.

ICEGLOBE floor model with a sphere of 30 cm. Stem available in 4 different heights. Diffuser made of self-extinguishing micropunched polycarbonate. Stem and base made of metal with a satin nickel finish. Dimmer included.

グローブ直径30cmのフロアタイプの「アイスグローブ」。ステムの長さの違いから、4つの高さが選べます。グローブは、ポリカーボネート(自己消化性素材)製。ステムとベースは、ニッケルサテン仕上げのメタル製。調光器付き。

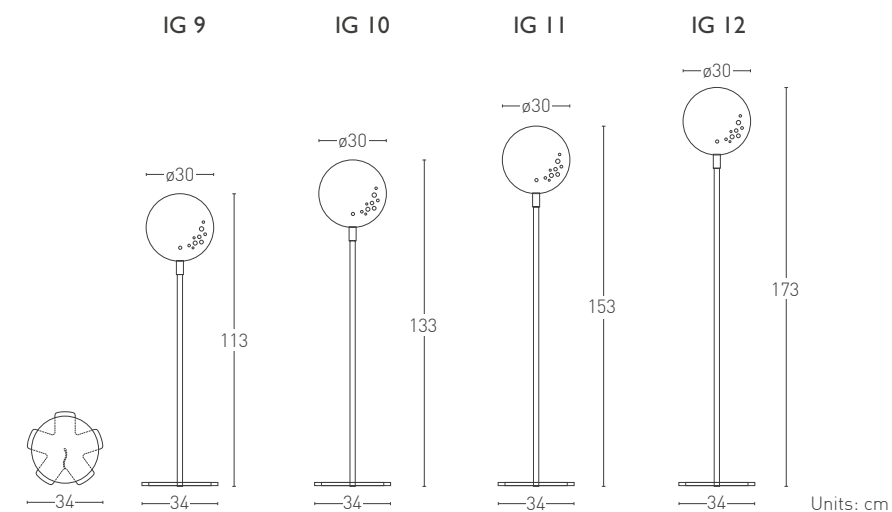

Finishes

● 166 Satin nickel

Diffuser

PC Polycarbonate

Cable

Transparent

Dimmer

Included

Suggested light source

E27 Halogen ECO
max 1x116W

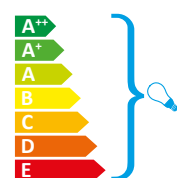

Certification

CE EAC PS E F IP20



ICEGLOBE L09/L10/L11

Design VillaTosca

ICEGLOBE da terra con sfera da 45 cm. Stelo disponibile in 3 diverse altezze. Diffusore realizzato in policarbonato microforato autoestinguente. Stelo e base realizzati in metallo con finitura nichel satinato. Regolatore di intensità luminosa incluso.

ICEGLOBE floor model with a sphere of 45 cm. Stem available in 3 different heights. Diffuser made of self-extinguishing micropunched polycarbonate. Stem and base made of metal with a satin nickel finish. Dimmer included.

フロアタイプの「アイスグローブ」。グローブは直径45cm。ステムの高さは3つの中から選べます。グローブは、ポリカーボネート(自己消化性素材)製。ステムとベースは、ニッケルサテン仕上げのメタル製。調光器付き。



Finishes

● 166 Satin nickel

Diffuser

PC Polycarbonate

Cable

Transparent

Dimmer

Included

Suggested light source

☞ E27 Halogen ECO
max 1x116W

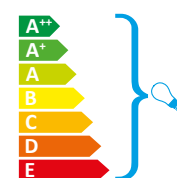

Certification

CE EAC PS E F IP20

IG L09

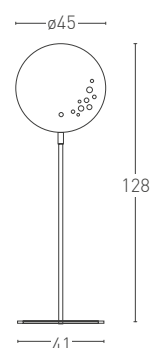

IG L10

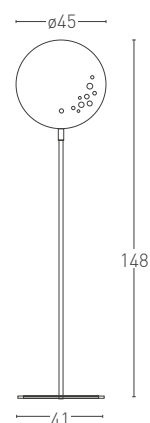

IG L11

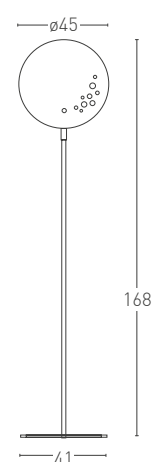

Units: cm



ICEGLOBE 03/L03

Design VillaTosca

ICEGLOBE da tavolo con sfera da 30 o 45 cm. Diffusore realizzato in policarbonato microforato autoestinguente. Stelo e base, realizzati in metallo con finitura nichel satinato. Regolatore di intensità luminosa incluso.

ICEGLOBE table model with a sphere of 30 or 45 cm. Diffuser made of self-extinguishing micropunched polycarbonate. Stem and base made of metal with a satin nickel finish. Dimmer included.

「アイスグローブ」のテーブルランプ。グローブは直径30、45 cmの二種類から構成されポリカーボネート（自己消化性素材）製。ステムとベースは、ニッケルサテン仕上げのメタル製。調光器付き。

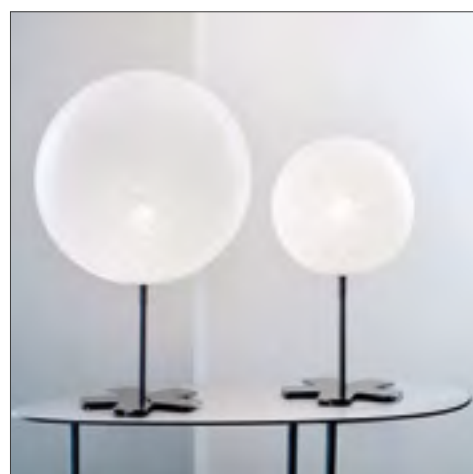

IG 03

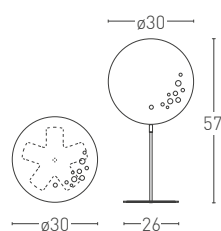

IG L03

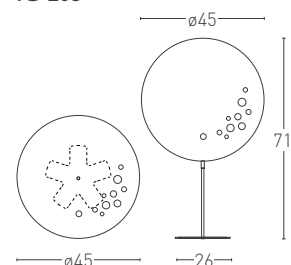

Units: cm



Finishes

● 166 Satin nickel

Diffuser

PC Polycarbonate

Cable

Transparent

Dimmer

Included

Suggested light source

 E27 Halogen ECO

ICEGLOBE 03 max 1x77W

ICEGLOBE L03 max 1x116W

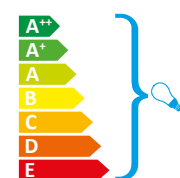

Certification

     IP20



ICEGLOBE 02/L02/MAXI 02/GIANT 02

Design VillaTosca

ICEGLOBE da tavolo e terra. Disponibile nei diametri da 30, 45, 57 e 78 cm. La sfera realizzata in policarbonato microforato e autoestinguente è appoggiata nella base metallica con finitura nichel satinato. Regolatore di intensità luminosa incluso.

ICEGLOBE table and floor model with diameters of 30, 45, 57 and 78 cm. The sphere, made of self-extinguishing micropunched polycarbonate, is supported on a metallic base characterized by a satin nickel finish. Dimmer included.

アイスグローブのテーブル/フロアタイプのランプ。グローブの直径は30、45、57、78cmから選べ、ポリカーボネート製で自己消化性素材です。ニッケルサテン仕上げのメタル製のベースに乗せたもので、調光器付き。

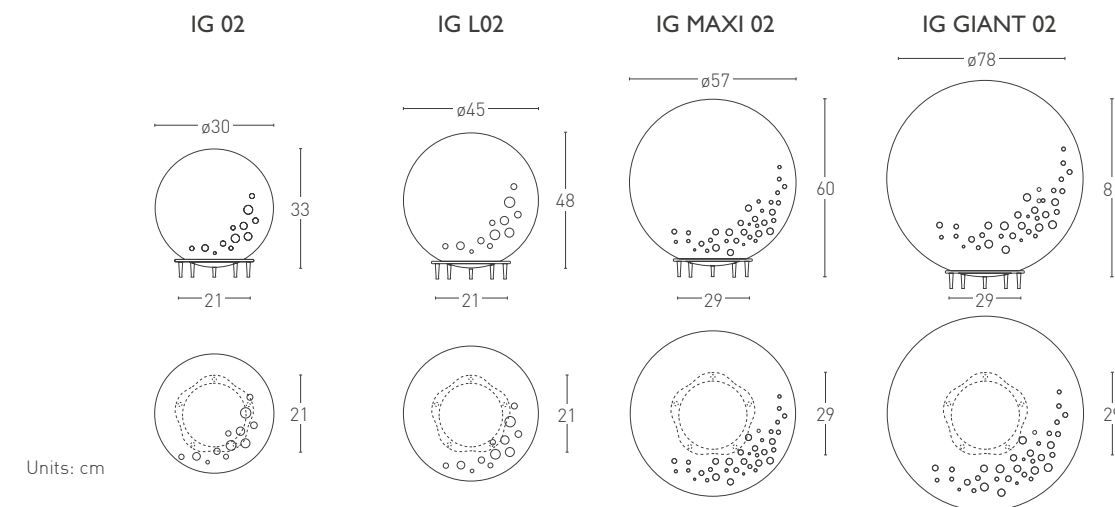

Finishes

- 166 Satin nickel

Diffuser

PC Polycarbonate

Cable

Transparent

Dimmer

Included

Suggested light source

E27 Halogen ECO

ICEGLOBE 02 max 1x77W

ICEGLOBE L02 max 1x116W

ICEGLOBE MAXI 02 max 1x116W

E27 Halogen ECO

ICEGLOBE GIANT 02 max 1x205W

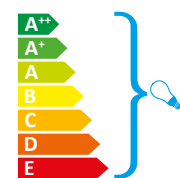

Certification



ICEGLOBE BUBBLE 3/5/10 / MINI BUBBLE 3/5/10

Design VillaTosca

ICEGLOBE BUBBLE, sospensione a cascata da 3, 5 o 10 elementi. Sfera realizzata in policarbonato autoestinguente microforato dal diametro di 30 e 20 cm per la versione MINI. Rosone per attacco a soffitto disponibile in bianco opaco con dettagli nichel satinato. Lunghezza cavo massima 3 metri.

ICEGLOBE BUBBLE, cascade suspension version composed of 3, 5 or 10 elements. Sphere made of self-extinguishing micropunched polycarbonate with a diameter of 30 and 20 cm for the MINI version. The canopy is available in white finish with details in satin nickel. Cable length: max 3 m.

「アイスグローブ・バブル」は、3、5または10個のエレメントのペンダントタイプ。グローブは、30cmと20cm（「ミニ」バージョン）のポリカーボネート（自己消化性素材）製。天井取り付け用フランジカバーは、ニッケルサテンとホワイト半光沢から選択可能。最大ケーブルの長さは、3メートル。

IG BUBBLE 3

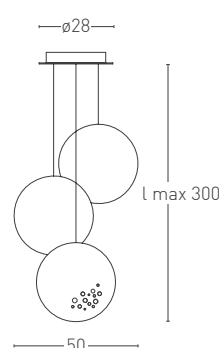

IG BUBBLE 5

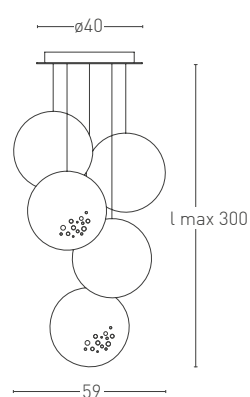

IG BUBBLE 10

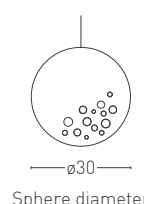
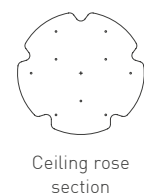
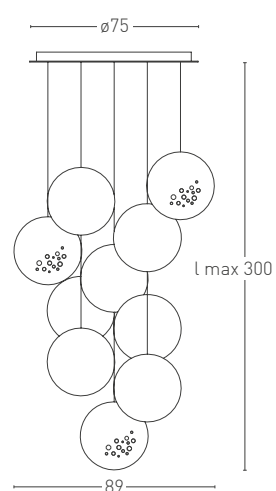

IG MINIBUBBLE 3

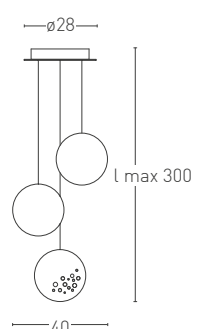

IG MINIBUBBLE 5

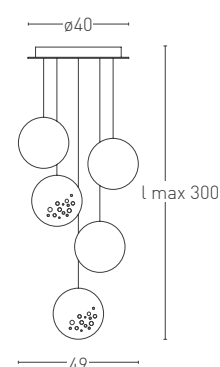

IG MINIBUBBLE 10

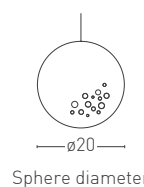
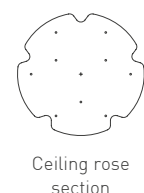
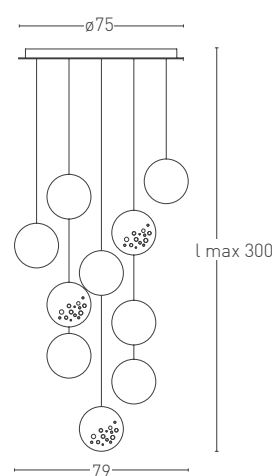

Finishes

Ceiling rose:

○ 106 Matt white

Details:

● 166 Satin nickel

Diffuser

PC Polycarbonate

Cable

Transparent

Suggested light source

IG BUBBLE 3/5/10

⦿ E27 Halogen ECO
max 3/5/10x77W

⦿ E27 ECO Fluo
max 3/5/10x24W

IG MINIBUBBLE 3/5/10

⦿ E27 Halogen ECO
max 3/5/10x42W

⦿ E27 ECO Fluo
max 3/5/10x11W

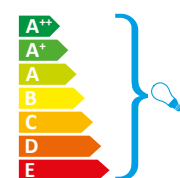

Certification

CE EAC PS E F Classe I IP20



Units: cm

ICEGLOBE MINI 02/S/21

Design VillaTosca

Sfera da 20 cm di diametro realizzata in polycarbonato microforato autoestinguente, declinata nelle versioni da tavolo, a parete e sospensione. Finitura dei dettagli metallici: nichel satinato.

Sphere with a diameter of 20 cm made of self-extinguishing micropunched polycarbonate, available in table, wall and suspension versions. Metal details finish: satin nickel.

自己消化性を持つポリカーボネート製の直径20cmのグローブを持つランプ。テーブルランプ、ウォールタイプ、ペンダントタイプの三種類で構成される製品。ディテール部品はメタル製のニッケル・サテン仕上げ。

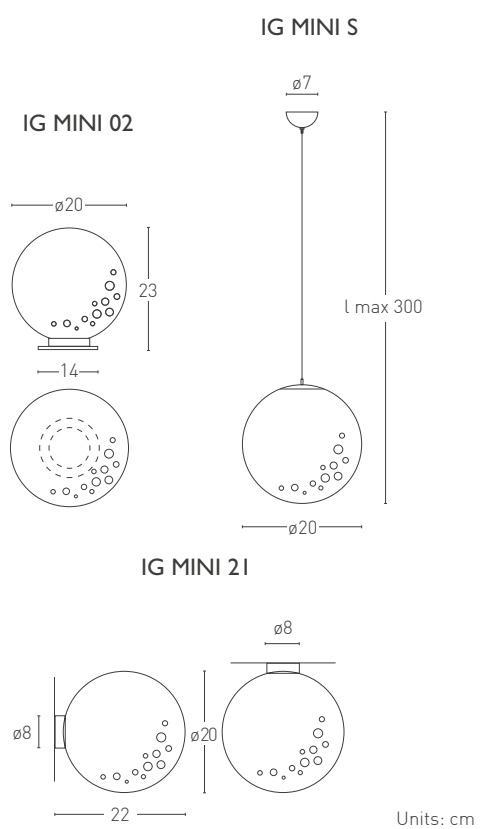
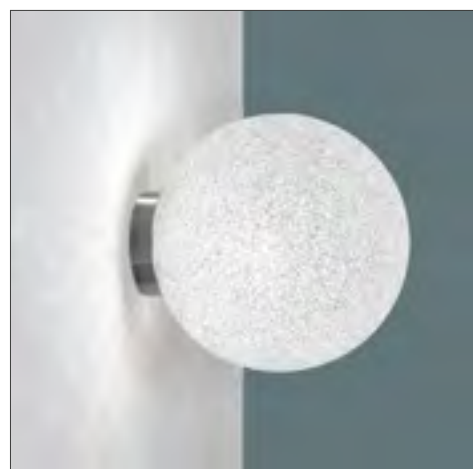

Finishes

● 166 Satin nickel

Diffuser

PC Polycarbonate

Cable

Transparent

Suggested light source

☞ E27 Halogen ECO
max 1x42W

☞ E27 ECO Fluo
max 1x11W

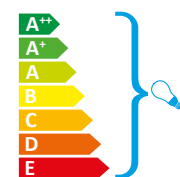

Certification

CE EAC PS E F IP20

IG MINI S/21 Classe I

IG MINI 02 □



ICEGLOBE MINI 21B/21BL

Design VillaTosca

Lampada da parete con stelo in due misure. Diffusore a sfera da 20 cm di diametro realizzato in policarbonato microforato auto-estinguente. Finitura delle parti metalliche: nichel satinato.

Wall lamp with stem available in two sizes. Sphere diffuser with a diameter of 20 cm made of self-extinguishing micropunched polycarbonate. Metal details finish: satin nickel.

二つのサイズを持つ、ステム付きウォールタイプのランプ。自己消化性を持つポリカーボネート製の直径20cmのグローブ。ディテール部品は、メタル製のニッケル・サテン仕上げ。

IG MINI 21B

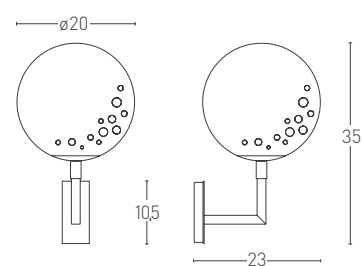

IG MINI 21BL

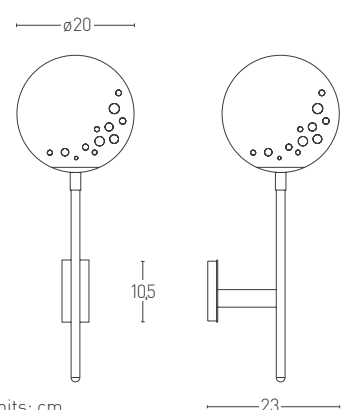

Units: cm



Finishes

● 166 Satin nickel

Diffuser

PC Polycarbonate

Suggested light source

 E27 Halogen ECO
max 1x42W

 E27 ECO Fluo
max 1x11W

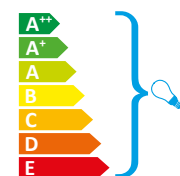

Certification

    Classe I IP20



ICEGLOBE MICRO 03

Design VillaTosca

Piccola lampada da tavolo con diffusore a sfera dal diametro di 12 cm realizzato in policarbonato microforato autoestinguente. Base e stelo realizzati in metallo laccato bianco opaco.

Small table lamp supplied with a sphere shape diffuser with a diameter of 12 cm made of self-extinguishing micropunched polycarbonate. Base and stem made of matt white lacquered metal.

グローブ直径12cm、ポリカーボネート（自己消化性）素材でできている小さなテーブルランプ。ベースとステムは、メタル製のホワイト半光沢塗。



Finishes

○ 106 Matt white

Diffuser

PC Polycarbonate

Cable

White

Suggested light source



G9 Halogen ECO
max 1x33W

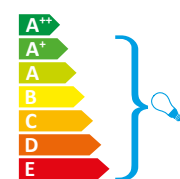

Certification

CE EAC PS E F IP20

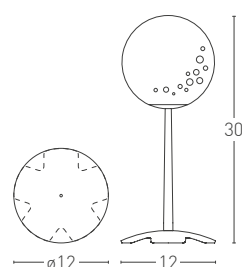
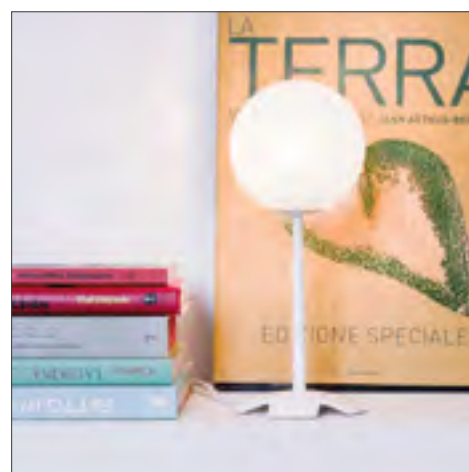

Units: cm



ICEGLOBE MICRO 21/21-I/S/S-I / BUBBLE 4/8/12/16

Design VillaTosca

Versioni a parete/plafone e sospensione con attacco a rosone o incasso con diffusori in policarbonato microforato autoestinguente. Sfere dal diametro di 12 cm. Dettagli metallici con finitura bianco opaco. Disponibile anche nella versione BUBBLE con 4 fino a 16 elementi.

Range of wall/ceiling and suspension lamps supplied with a ceiling rose or a built-in kit with diffusers made of self-extinguishing micropunched polycarbonate. Spheres with a diameter of 12 cm. Metal details in matt white finish. Also available in the BUBBLE version from 4 to 16 elements.

ウォール/シーリング/ペンダントの三種類で構成されるバージョン。フランジカバーあるいは壁面埋め込み式のランプ。自己消化機能を持つポリカーボネート直径12cmのグローブ。ホワイト半光沢塗装のメタルをディテールに使用。4個から16個までのグローブを吊り下げられる「バブル」のバージョンも用意しています。

IG MICRO 21

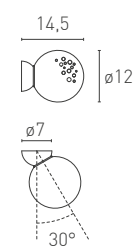

Adjustable with a 30° angle

IG MICRO 21-I

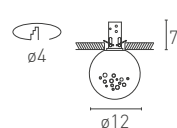

IG MICRO BUBBLE 4

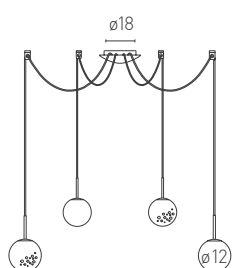

IG MICRO BUBBLE 8

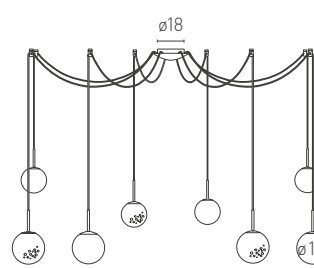

IG MICRO BUBBLE 12

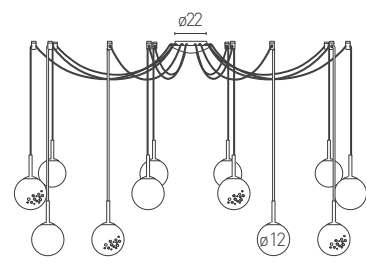

IG MICRO S

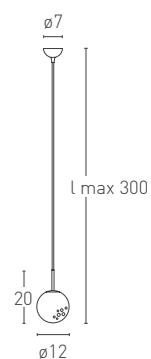

IG MICRO S-I

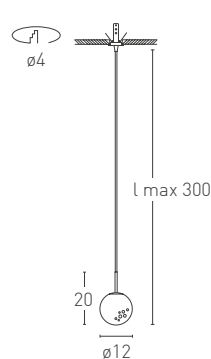

IG MICRO BUBBLE 16

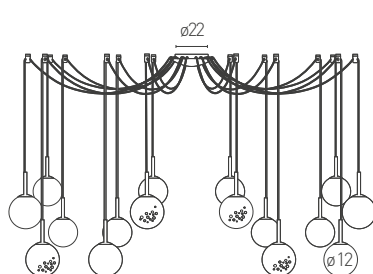

Units: cm

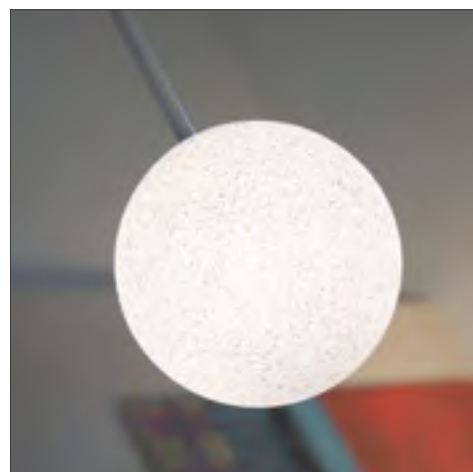

Finishes

○ 106 Matt white

Diffuser

PC Polycarbonate

Cable

White

Suggested light source



G9 Halogen ECO

IG MICRO 21/21-I/S/S-I max 1x33W

IG MICRO BUBBLE 4 max 4x33W

IG MICRO BUBBLE 8 max 8x33W

IG MICRO BUBBLE 12 max 12x33W

IG MICRO BUBBLE 16 max 16x33W

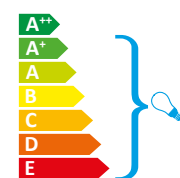

Certification



ICEGLOBE MICRO A2/A4/A6

Design VillaTosca

Lampade da parete a 2, 4 o 6 elementi. Struttura metallica con finitura bianco opaco. Diffusori a sfera dal diametro di 12 cm realizzati in policarbonato microforato autoestinguente.

Wall lamp available in 2, 4 or 6 elements. Metal structure with a matt white finish. Sphere diffuser with a diameter of 12 cm made of self-extinguishing micropunched polycarbonate.

2、4、6灯式のウォールタイプのランプ。本体はメタル製ホワイト半光沢仕上げ。グローブは直径12cm、ポリカーボネート（自己消化性）素材でできています。



Finishes

○ 106 Matt white

Diffuser

PC Polycarbonate

Suggested light source



G9 Halogen ECO

MICRO A2 max 2x33W

MICRO A4 max 4x33W

MICRO A6 max 6x33W

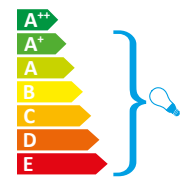

Certification

CE EAC PS E F Classe I IP20

IG MICRO A2

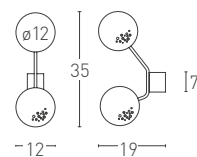

IG MICRO A4

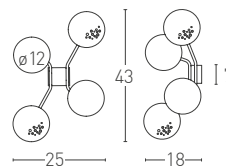

IG MICRO A6

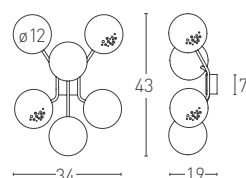

Units: cm

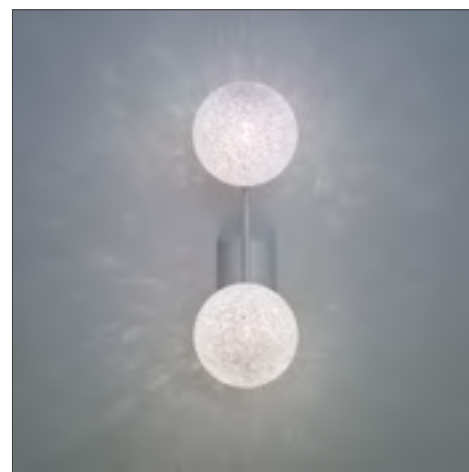
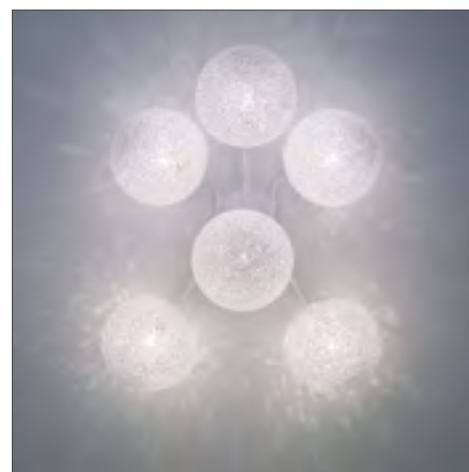

ICEGLOBE MICRO P/I6L

Design VillaTosca

Plafoniera e sospensione rispettivamente da 12 e 16 luci. Struttura metallica laccata bianco opaco. Diffusori a sfera dal diametro di 12 cm realizzati in policarbonato microforato autoestinguente.

Ceiling and suspension version respectively with 12 and 16 lights. Metal structure lacquered in matt white. Sphere diffusers with a diameter of 12 cm made of self-extinguishing micropunched polycarbonate.

12灯シーリングタイプと16灯ペンダントタイプから構成される製品。メタル製ホワイト半光沢塗装の本体。グローブは直径12 cm、ポリカーボネート（自己消化性）素材でできています。



IG MICRO P

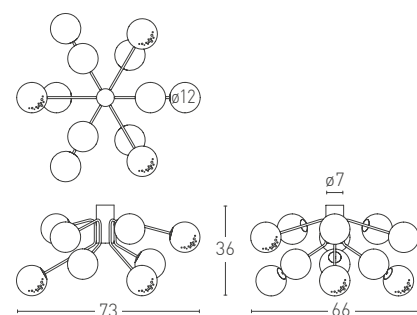

IG MICRO I6L

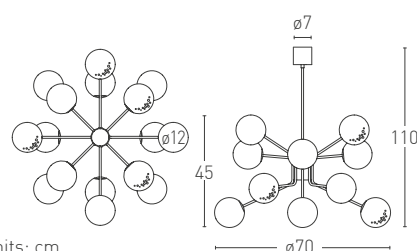

Units: cm

Finishes

○ 106 Matt white

Diffuser

PC Polycarbonate

Suggested light source



G9 Halogen ECO

MICRO P max 12x20W

MICRO I6L max 16x20W

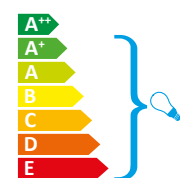

Certification

CE ENEC PS E F Classe I IP20

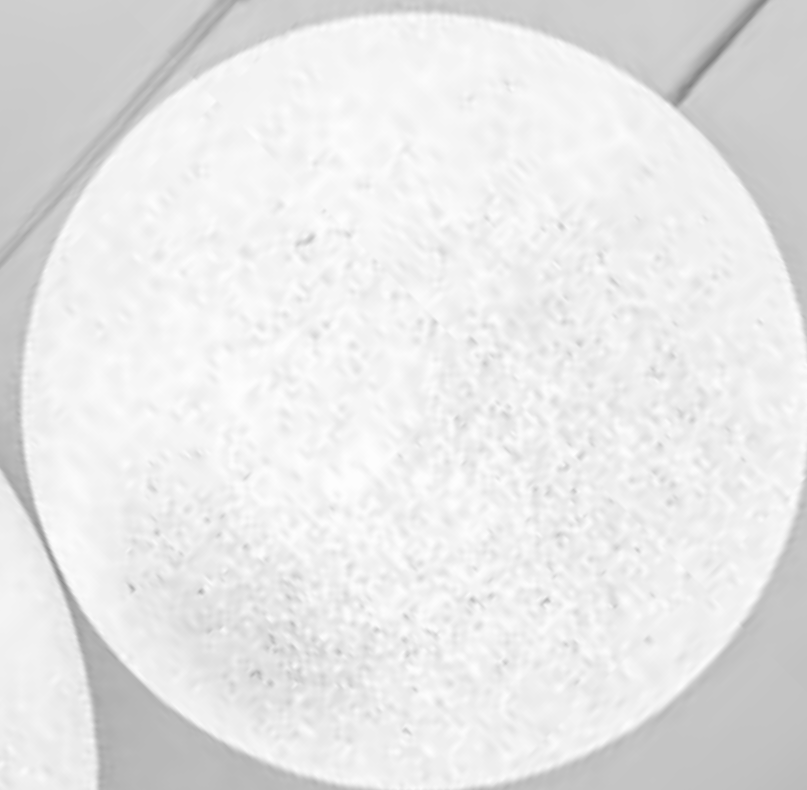
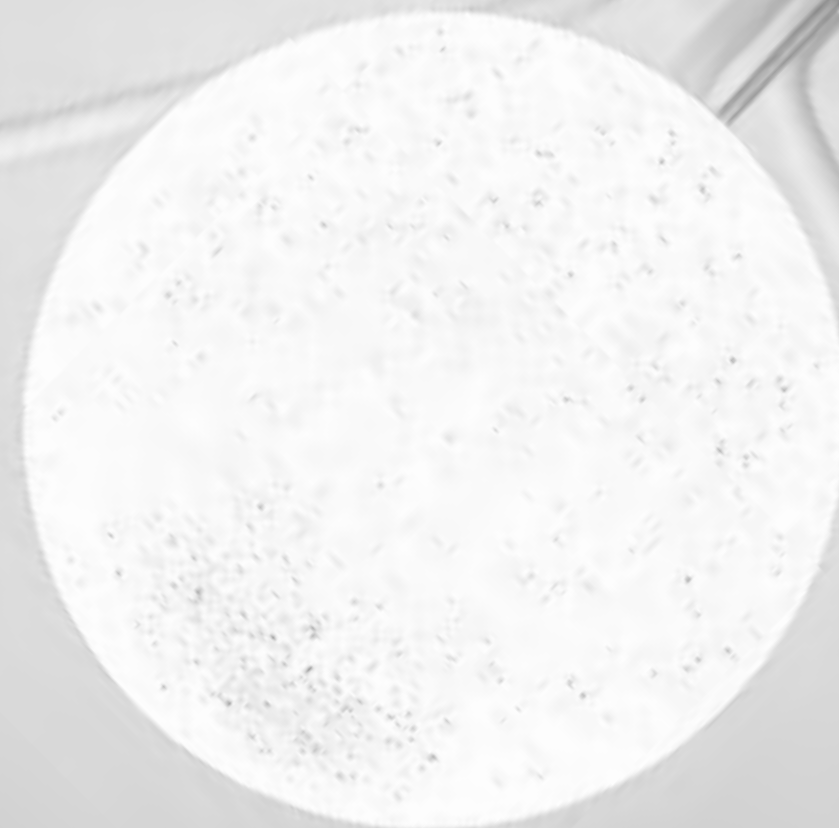
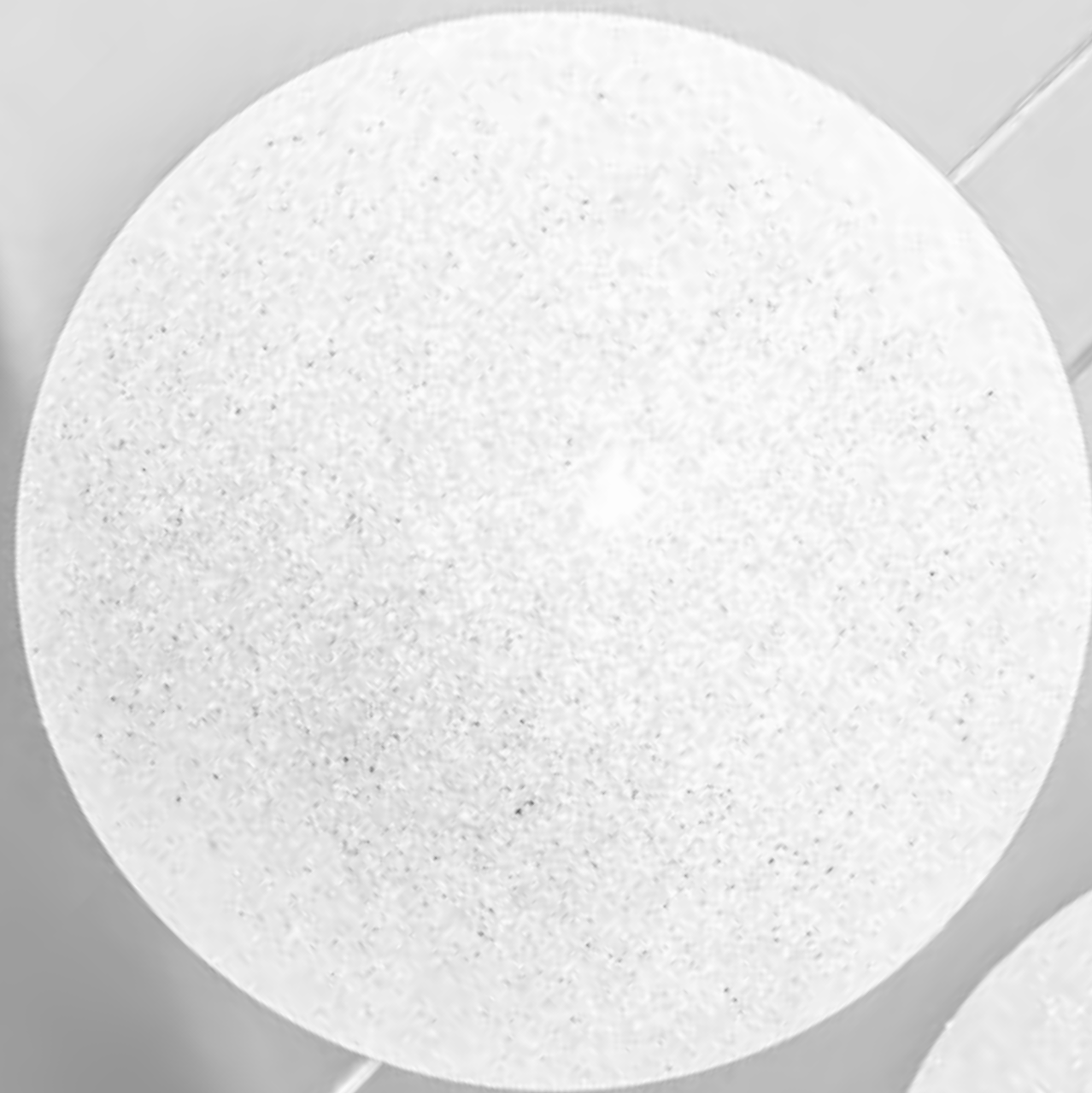

LUCE ARTICA

Collezioni di sospensioni in policarbonato microforato e rosoni in ABS bianco opale. Disponibile anche nella versione a sospensione multipla con struttura in metallo verniciato bianco opaco.

ARTIC LIGHT

Collection of suspensions in micro-punched polycarbonate with ceiling rose in ABS opal white. Also available as multiple suspension with metal structure painted in matt white.

北極からのひかり

ビーズ状のポリカーボネート製のグローブを持つペンダントタイプのシリーズ。フランジはABS樹脂製オパール・ホワイト。複数のグローブ（3体あるいは5体）のマルチ・ペンダントバージョンを用意しています。この筐体は、メタル製ホワイト半光沢塗装。

ICELIGHT 20/30/45/60/60 SEMI

Design VillaTosca

ICELIGHT è una collezione di lampade a sospensione che sfrutta al massimo le potenzialità dello stampaggio polimerico e che standardizza il prodotto per renderlo semplice e versatile per il settore contract e grandi forniture. L'attacco a soffitto è realizzato interamente in ABS bianco opaco ed è standard per tutta la collezione. La sfera è disponibile nei diametri: 20, 30, 45, 57 cm e nella versione SEMI da 57 cm di diametro. Cavo autoportante, attacco E27.

ICELIGHT is a collection of suspension lamps in polymer moulding, simple and versatile for contract and supplies sectors. The ceiling rose is entirely in matt white ABS, standard for all the collection. Sphere diameters: 20, 30, 45, 57 cm and SEMI version in 57 cm diameter. Self-supporting power cable, socket E27.

「アイスライト」は、樹脂成型の可能性を最大限に生かしたペンダントランプシリーズです。大小用意されたシンプルなデザインは様々な空間で自由な使い方が可能で、コントラクト等の大規模利用に最適です。全てのサイズに採用されているフランジカバーとランプボディはホワイト半光沢のABS製。グローブ部は、直径20、30、45、57cmと半球体57cmの5種類が用意されています。

(品名:20、30、45、60、SEMI60)

吊ケーブルは電源ケーブル兼用。電球金口はE27。

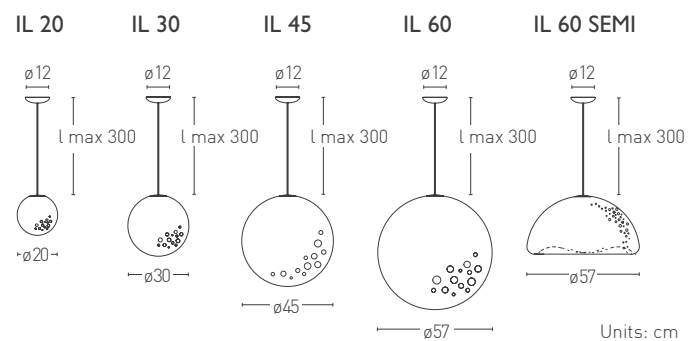

Finishes

○ ABS White

Diffuser

PC Polycarbonate

Cable

Transparent

Suggested light source

E27 Halogen ECO

IL 20 max 1x42W

IL 30 max 1x77W

IL 45/60/60S max 1x116W

E27 ECO Fluo

IL 20 max 1x11W

E27 ECO Fluo

IL 30/45/60/60S max 1x24W

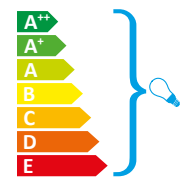

Certification



ICELIGHT PENDANT 3/5

Design VillaTosca

Attacco a soffitto dotato di 3 o 5 bracci disposti a raggiera che consente la libera configurazione di sospensioni utilizzando 3 o 5 sfere a scelta tra i diametri 20, 30, 45 cm della collezione ICELIGHT. Finitura bianco opaco.

Ray system ceiling rose with 3 or 5 arms; the lamp allows the free configuration of the suspensions settings using 3 or 5 spheres (diameters 20, 30, 45 cm) of ICELIGHT collection. Matt white finish.

天井取り付けベースに3つあるいは5つのアームを備えたペンダントタイプのランプ。アイスライトシリーズのグローブ(20、30、45 cm)から組み合わせが自由に選択できます。塗装はホワイト半光沢。

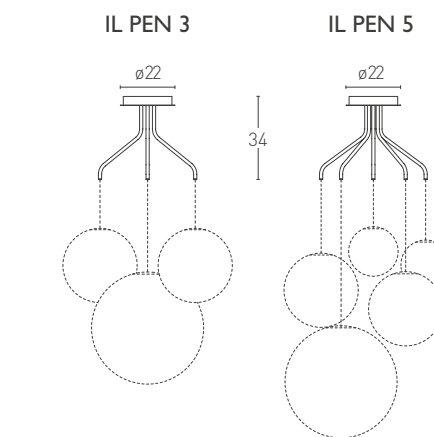

Units: cm

ICELIGHT PENDANT COMPOSITION

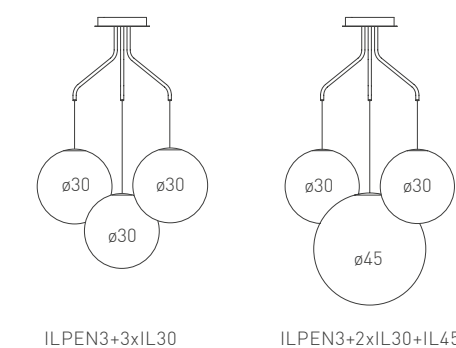

ILPEN3+3xIL30

ILPEN3+2xIL30+IL45

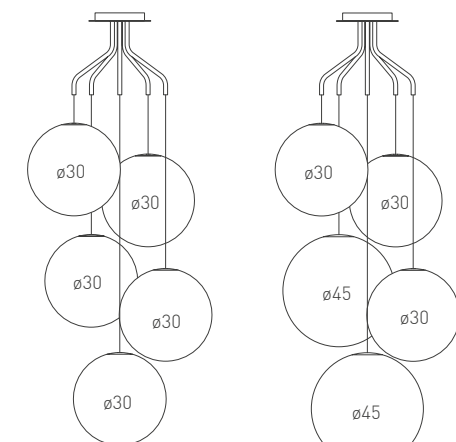

ILPEN5+5xIL30

ILPEN5+3xIL30+2xIL45



Finishes

○ 106 Matt white

Diffuser

PC Polycarbonate

Cable

Transparent

Certification



LEAVES

Design VillaTosca

VEGETAZIONE LUMINOSA

LEAVES è una divertente collezione di sospensioni, applique e plafoniere dal colorato fogliame metallico. Le molteplici e diverse versioni si adattano perfettamente ad ambienti giovani, accoglienti e familiari. Disponibili nei colori: rosso lucido, verde chartreuse, nero lucido, bianco lucido, foglia oro e foglia argento.

LIGHTING GREENERY

LEAVES is a pleasant collection of suspension lamps, wall lamps and ceiling lamps supplied with a colored metal foliage. The various versions are perfectly suited for use in familiar, comfortable and young settings. Available in the colors: glossy red, chartreuse green, glossy black, glossy white gold/silver foil.

緑豊かなあかり

「リーブス」は、鮮やかな色合いの金属製の群葉が特徴的な楽しいシリーズです。ペンダントタイプ、ウォール/シーリングタイプなど多様なバージョン展開により、若者向けにも、普段使いのくつろぎ空間にも完璧にマッチします。カラー展開は、レッド光沢、ライトグリーン光沢、ブラック光沢、ホワイト光沢、金箔、銀箔仕上げの6種類を用意しております。

LEAVES S/21

Design VillaTosca

LEAVES è la più piccola versione della serie, disponibile come sospensione o applique/plafone. Realizzata in fogli di metallo tagliati a laser e successivamente modellati a mano, è disponibile nelle finiture: nero lucido, bianco lucido, verde chartreuse, rosso, foglia oro e foglia argento. Per la versione a sospensione, è possibile decentrare l'attacco a soffitto rispetto al rosone o ordinare un rosone con doppia uscita per collegare due lampade.

LEAVES is the smallest version of the collection, available as suspension or wall/ceiling lamp. Made of metal leaves shaped by hand. Available in glossy black, glossy white, chartreuse green, red, gold and silver foil finishes. The suspension lamps may be mounted on the ceiling off centre with respect to the ceiling rose alternatively a double socket ceiling rose is available to facilitate the connection of two lamps.

「リーフス」シリーズの中で一番小さな製品。ペンダント/シーリング/ウォールタイプの三種類に対応することができます。レーザーカットされたメタルを手作業で折り曲げています。塗装は、ブラック光沢、ホワイト光沢、ライトグリーン、レッド、金箔仕上げ、銀箔仕上げの中から選択できます。ペンダントタイプの場合は、フランジから別の位置に配置することができます。さらに、オーダーでひとつのフランジから二体のランプに電源供給することも可能です。

LEAVES S

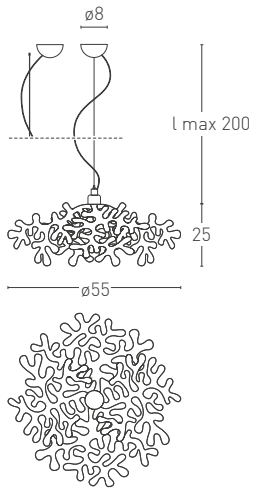

LEAVES 21

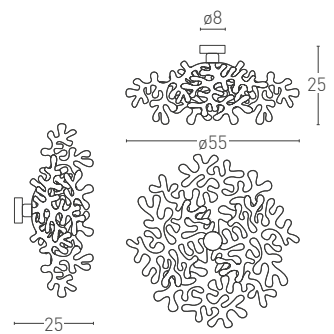

Units: cm



Finishes

- 112 Glossy black
- 114 Glossy white
- 119 Chartreuse green
- 120 Red
- 130 Gold foil
- 131 Silver foil

Cable

Transparent

Light source

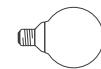

LEAVES S

E27 ECO Fluo Globe ø100 mm
max 1x24W

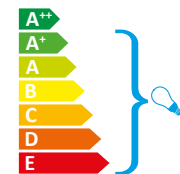

Suggested light source

LEAVES 21

E27 Special Mirror Silver
max 1x100W

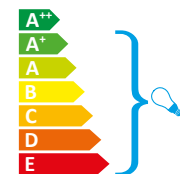

Certification

CE EAC PS E F Classe I IP20



MIDILEAVES / SUPERLEAVES

Design VillaTosca

MIDILEAVES e SUPERLEAVES sono le versioni a sospensione rispettivamente dal diametro di 75 e 105 cm. Realizzata in fogli di metallo tagliati a laser e successivamente modellati a mano, è disponibile nelle finiture: nero lucido, bianco lucido, verde chartreuse, rosso, foglia oro e foglia argento.

MIDILEAVES and SUPERLEAVES are the suspension versions available respectively with a diameter of 75 and 105 cm. Made of laser cut metal leaf shaped by hand, available in glossy black, glossy white, chartreuse green, red, gold/silver foil finishes.

「ミディリーブス(直径75cm)」、「スーパリーブス(直径105cm)」は、シャンデリアタイプのバージョンです。レーザーカットされたメタルを手作業で折り曲げています。塗装は、ブラック光沢、ホワイト光沢、ライトグリーン、レッド、金箔仕上げ、銀箔仕上げの中から選択できます。

MIDILEAVES

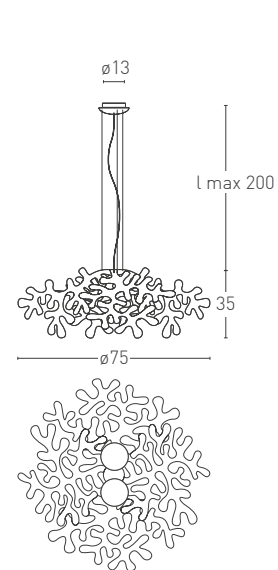

SUPERLEAVES

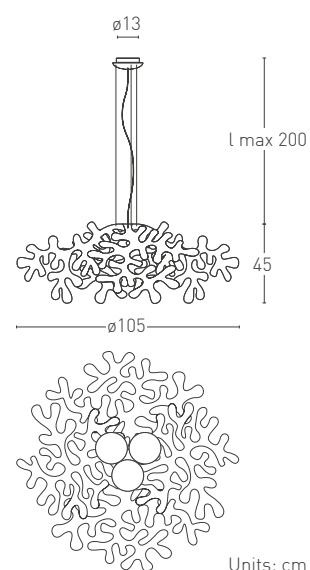

Units: cm

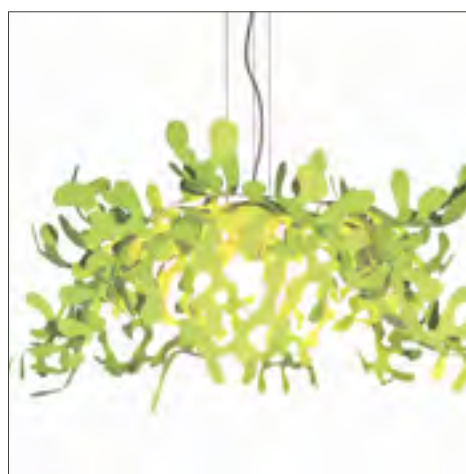

Finishes

- 112 Glossy black
- 114 Glossy white
- 119 Chartreuse green
- 120 Red
- 130 Gold foil
- 131 Silver foil

Cable

Transparent

Light source

E27 ECO Fluo Globe ø100 mm

MIDILEAVES max 2x24W 220/240V
2900lm 2700K

SUPERLEAVES max 3x24W 220/240V
5550lm 2700K

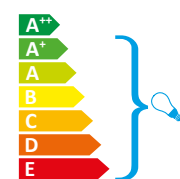

Certification

CE EAC PS E F Classe I IP20



IRONIA E SEMPLICITÀ

MAIL, serie di applique disegnate da Alberto Saggia e Valerio Sommella, è protagonista dell'illuminazione di Casa Taide - l'innovativo progetto degli architetti Rui Vieira Oliveira e Vasco Manuel Fernandez realizzato a Taide, Póvoa de Lahnoso (Portogallo) e vincitore dei premi Architizer: A+ Award 2015 Jury Winner e A+ Awards 2015 Popular Choice Winner.

IRONY AND SIMPLICITY

Mail, wall lamp series designed by Alberto Saggia and Valerio Sommella, is protagonist of Casa Taide illumination - an innovative project by the architects Rui Vieira Oliveira and Vasco Manuel Fernandez realized in Taide, Póvoa de Lahnoso (Portugal) and winner of Architizer awards: A+ Award 2015 Jury Winner e A+ Awards 2015 Popular Choice Winner.

アイロニーとシンプルさ

「メール」は、アルベルト・サジヤとヴァレリオ・ソムメラによってデザインされたウォールタイプのランプ。このランプは、アメリカの建築・デザインWEBサイト「アルキタイザー(Architizer)」主催の「A+Awards」賞で審査員賞およびポピュラーチョイス賞の二つを受賞したプロジェクト「タイデ邸 (Taide House)」(設計: ルイ・ヴィエーラ・オリヴィエーラ+ヴァスコ・マヌエル・フェルナンデス/ポルトガル)に使用されました。

MAIL / MAIL S

Design Alberto Saggia+Valerio Sommella

MAIL è l'ironica collezione di applique disegnata da Alberto Saggia e Valerio Sommella per LUMEN CENTER ITALIA. In queste pagine viene presentata nella versione "regular" (l 34 cm) e "small" (l 19 cm). Entrambe forniscono luce indiretta attraverso una sorgente LED o alogena ECO Energy Saver.

MAIL e MAIL S sono disponibili in cinque diverse finiture: bianco opaco, grigio sabbia FT, grigio perla, foglia oro e foglia rame.

MAIL is the ironic collection of wall lamps designed by Alberto Saggia and Valerio Sommella for LUMEN CENTER ITALIA. In these pages it is presented in its "regular" (l 34 cm) and "small" (l 19 cm) versions. They both produce indirect light using a LED system or an ECO Energy Saver halogen light source.

MAIL and MAIL S are available in five different finishes: matt white, sand grey FT, pearl grey, gold foil and copper foil.

「メール」は、アルベルト・サッジャとヴァレリオ・ソンメッラがルーメンセンター・イタリアのためにデザインしたシニカルな作品。このページでは、レギュラーサイズ（幅34 cm）とスモールサイズ（幅19 cm）の製品を紹介します。両方ともLED光源とエコハロゲン・エナジーセーバーのランプの二種類を取り揃えています。「メール」と「メール S」は、以下の五種類の塗装から選ぶことができます。ホワイト半光沢、サンド・グレーFT、パール・グレー、金箔仕上げ、銀箔仕上げ。

MAIL S

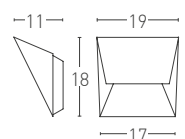

MAIL

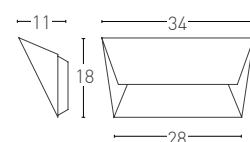

Units: cm

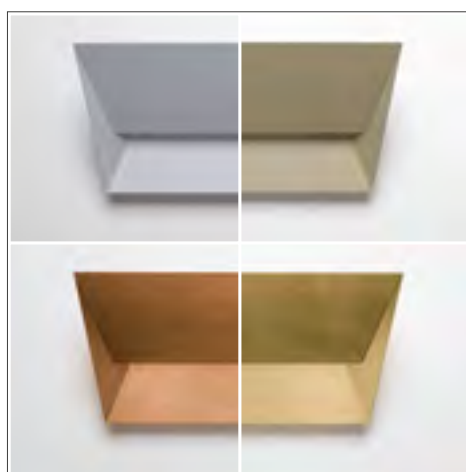
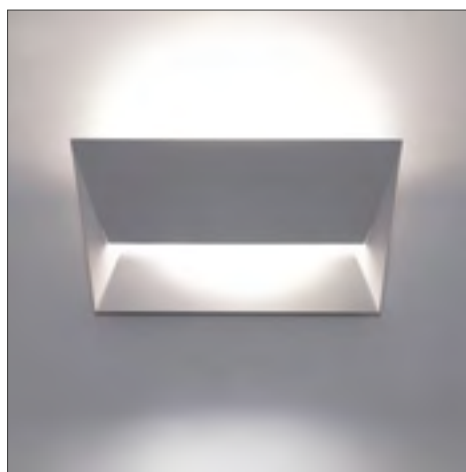

Finishes

- 106 Matt white
- 115R FT Sand grey
- 123 Pearl grey
- 130 Gold foil
- 132 Copper foil

Electronic driver

MAIL S LED Drive included
MAIL LED Dimmable driver included TRIAC

Light source LED

MAIL S LED
LED 9,2W 220/240V
780lm 3000K CRI>90

MAIL LED
LED 25W 220/240V
2320lm 3000K CRI>90



Suggested light source



MAIL S G9 Halogen ECO
max 1x60W

MAIL R7s Linear Halogen ECO 114,2 mm
max 1x230W

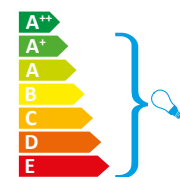

Certification



CASA TAÍDE

project by
R. Oliveira &
V. M. Fernandez
Architects

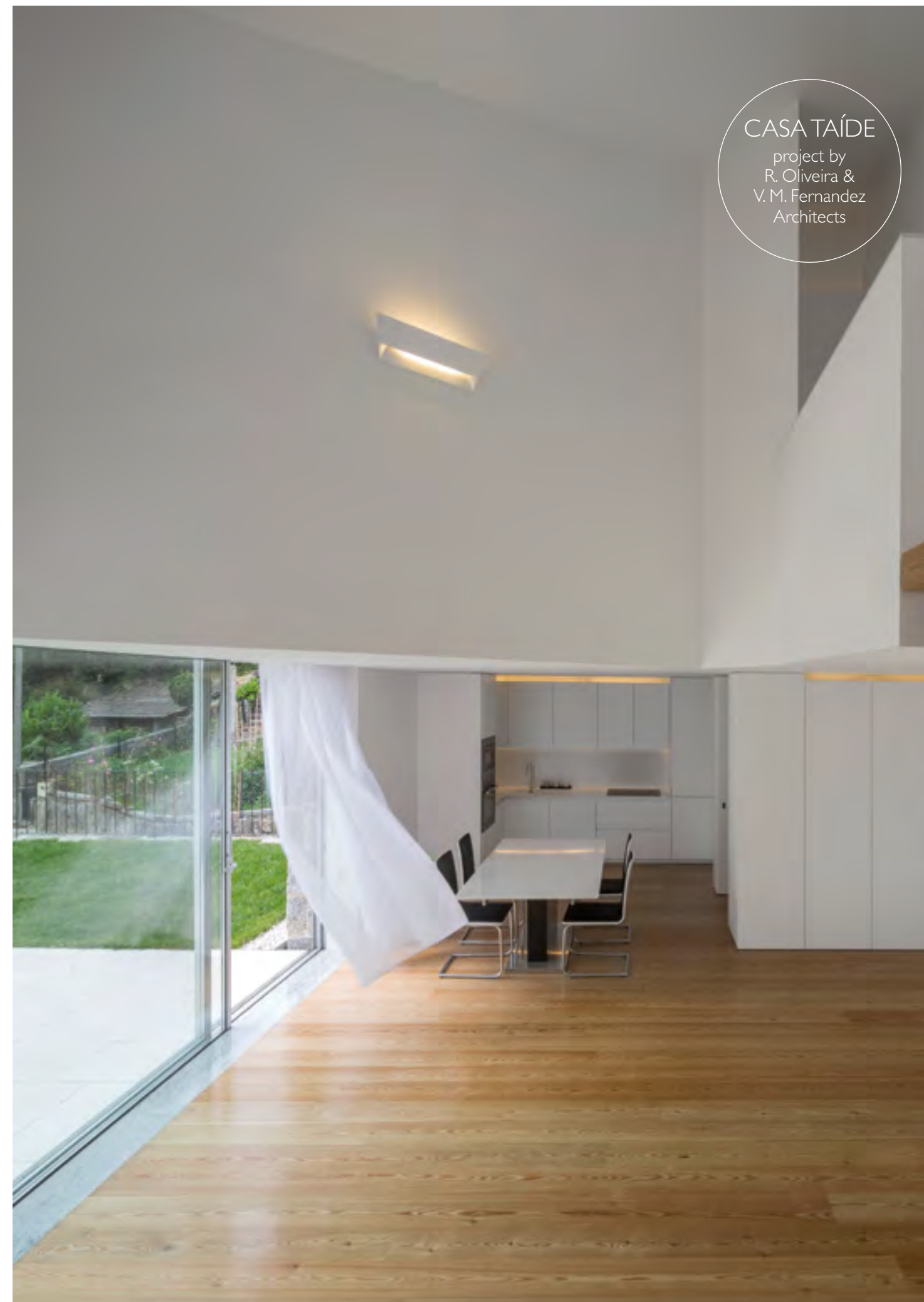

MAIL L/XL

Design Alberto Saggia+Valerio Sommella

MAIL L e XL nella versione "large" (l 56 cm) e "extra large" (l 81 cm). Utilizzano sorgenti LED o fluorescenti ECO Energy Saver.

Disponibili in cinque diverse finiture: bianco opaco, grigio sabbia FT, grigio perla, foglia oro e foglia rame.

MAIL L and XL in "large" (l 56 cm) and "extra large" (l 81 cm) versions with embedded LED or Ecoflu light source.

Available in five different finishes: matt white, sand grey FT, pearl grey, gold foil and copper foil.

「メールL」と「メールXL」は、ラージサイズ（幅56 cm）とエクストラ・ラージサイズ（幅81 cm）の製品です。両方ともLED光源とエコハロゲン・エナジーセーバーのランプの二種類を取り揃えています。以下の五種類の塗装から選ぶことができます。ホワイト半光沢、サンド・グレーFT、パール・グレー、金箔仕上げ、銀箔仕上げ。

CASA TAÍDE

project by
R. Oliveira &
V.M. Fernandez
Architects

MAIL L

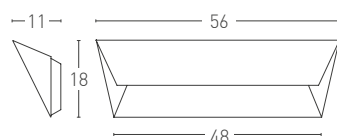

MAIL XL

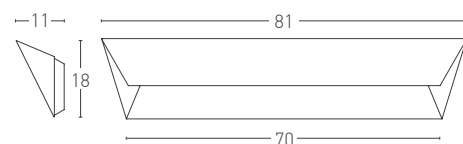

Units: cm



Finishes

- 106 Matt white
- 115R FT Sand grey
- 123 Pearl grey
- 130 Gold foil
- 132 Copper foil

Electronic driver

Included for LED version only:
Dimmable TOUCH DIM, DALI

Light source LED

MAIL L LED
LED TOTAL POWER 40W 220/240V
3765lm 3000K CRI>90

MAIL XL LED
LED TOTAL POWER 60W 220/240V
5650lm 3000K CRI>90

A

Light source

MAIL L
ECO Fluo 2G11 220/240V
1x24W 1800lm 3000K **AL.EL.**

MAIL XL
ECO Fluo 2G11 220/240V
1x55W 4800lm 3000K **AL.EL.**

A

Certification

CE EAC IP20 Classe I

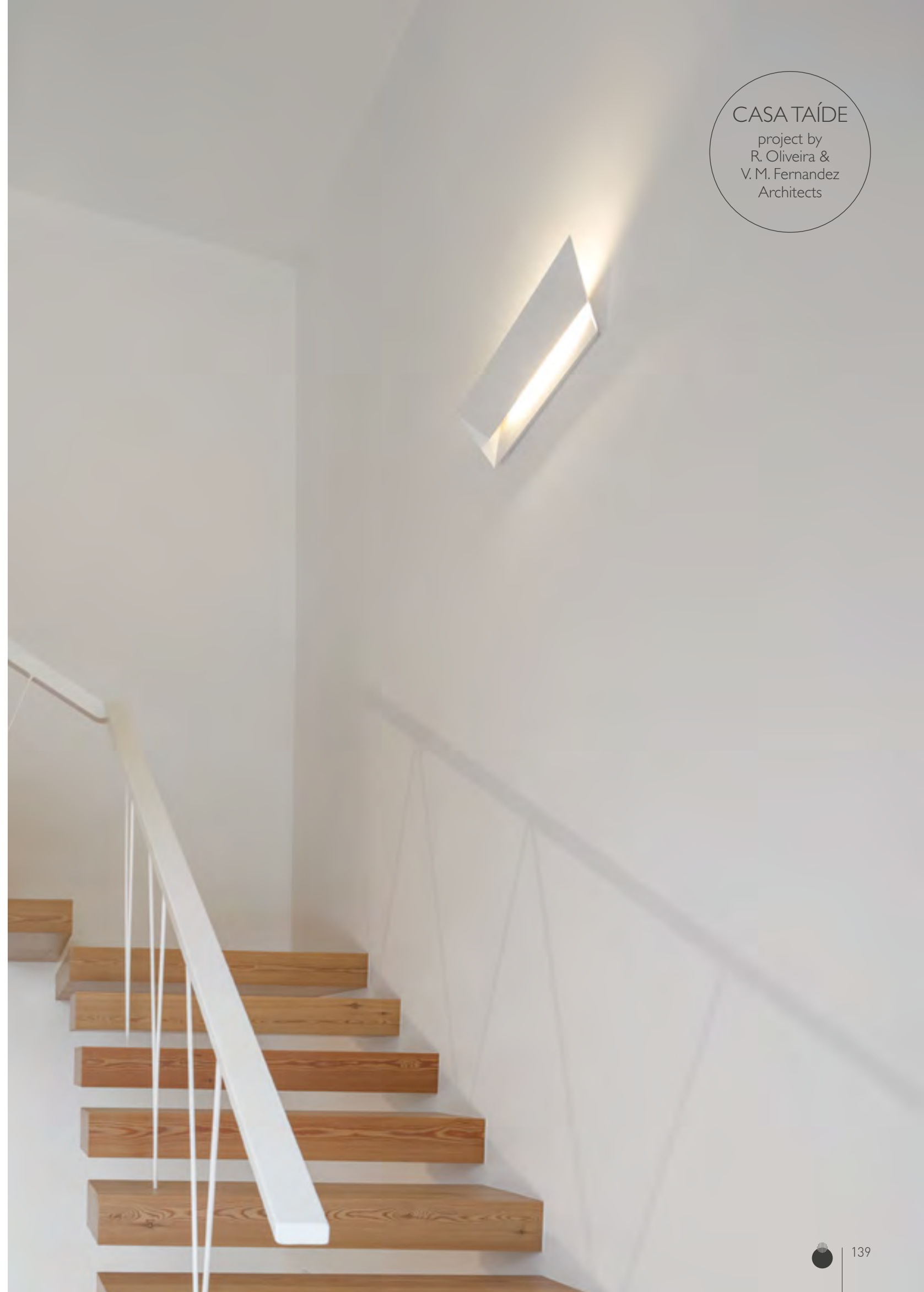

MAIL

Design Alberto Saggia+Valerio Sommella

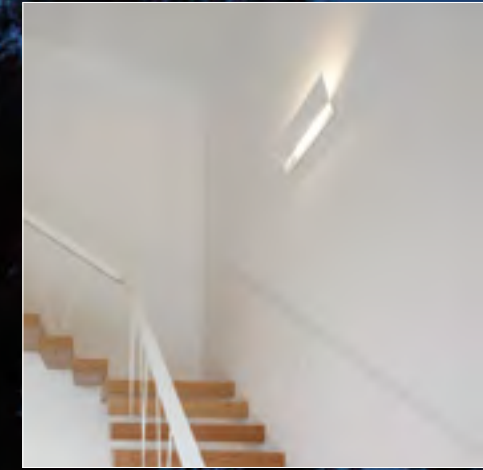
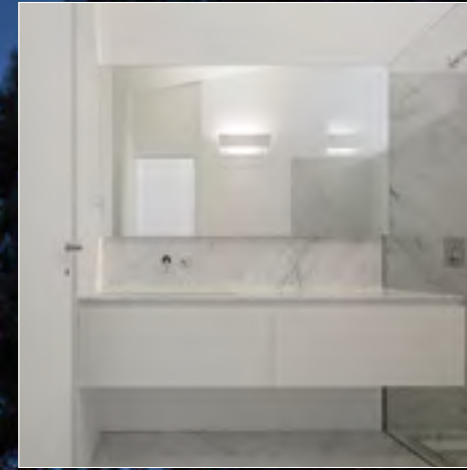
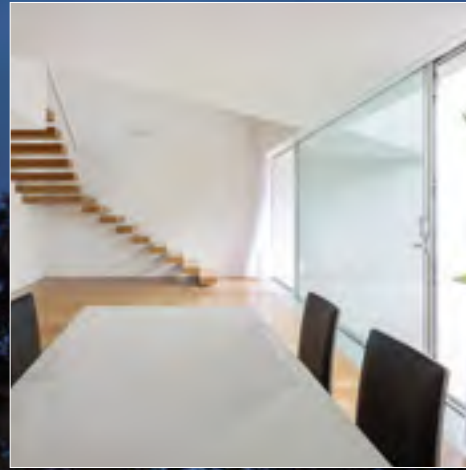
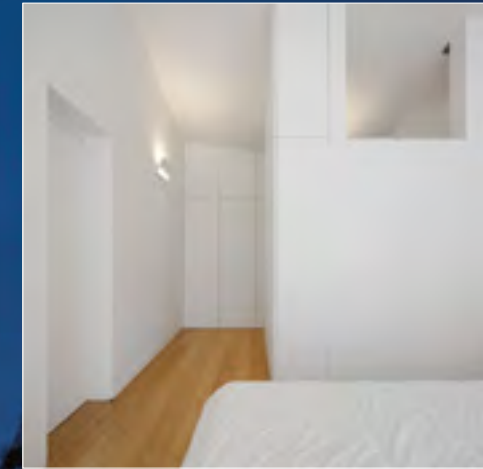
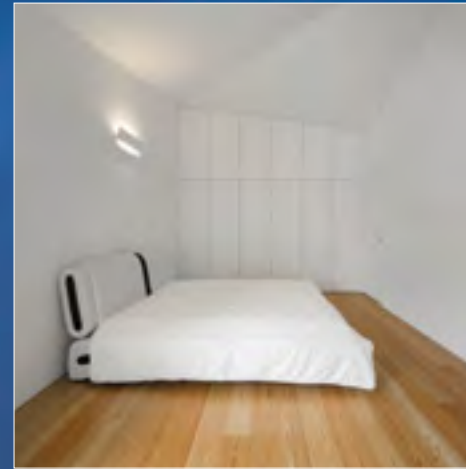

CASA TAÍDE
project by
R. Oliveira &
V. M. Fernandez
Architects



PUNTI DI LUCE

PINCO&PALLINO, collezione di illuminazione puntuale a sorgente LED. PINCO, PALLINO, e PALLINO LIP diventano la sorgente luminosa ideale per illuminare piccoli spazi, per fare luce su banconi e penisole, oppure come punto luce in serie a soffitto e parete. Ogni prodotto è presentato nelle versioni applique, sospensione e nelle versioni applique e sospensione da incasso per renderne più agevole l'installazione in abbassamenti, contropareti e soffitti.

POINTS OF LIGHT

PINCO&PALLINO, line of spot lights using LED light source. PINCO, PALLINO and PALLINO LIP are the ideal light source to light up small spaces, to provide light on counters and peninsulas, or as an in-line light source on ceiling or wall. Each product is presented in the following versions: wall lamp, suspension and in their built-in versions, suitable for lowerings, double walls and ceilings.

点のひかり

「ピンコ&パल्लीノ」はLEDを光源に持つポイントライトシリーズです。限られた空間のカウンターや長テーブルを照らす為の理想的な照明ですが、スポット/アクセントライトとして天井や壁に使用するにも最適です。各デザインにウォール/シーリング/ペンダント、タイプを用意しており、埋め込みタイプのモデルは壁や天井の穴に簡単に設置できるバイオネット式の取り付け金具を有しています。

PINCO 21/21-I/S/S-I

Design VillaTosca

PINCO 21 e PINCO 21-I, piccoli punti luce da parete o soffitto. La versione 21 è dotata di alimentatore integrato nella base, mentre, la versione 21-I da incasso, può essere fornita con diversi alimentatori remoti a seconda del numero di lampade installate.

PINCO S e PINCO S-I, punti luce a sospensione disponibili anche nella versione ad incasso. Diffusore realizzato in metacrilato trasparente. Sorgente luminosa LED da 4,5W 430lm, 3000K, CRI>90. Finiture disponibili: bianco opaco, nero opaco e cromato.

PINCO 21 and PINCO 21-I are small wall or ceiling spot lights. The 21 version is equipped with an electronic driver integrated into the base, while the 21-I recessed lighting version can be provided with different remote electronic drivers according to the number of lamps installed.

PINCO S and PINCO S-I are pendant spot lights also available in recessed lighting. Diffuser in transparent methacrylate. LED light source of 4,5W 430lm, 3000K, CRI>90. Finishes: matt white, matt black and chrome.

「ピンコ21&ピンコ21-I」は壁や天井に設置する小さなポイントライトです。バージョン「21」はドライバー内蔵型、バージョン「21-I」は埋め込み型でドライバーは必要な照明の数にあわせて別置で設定ができます。

「ピンコS&ピンコS-I」はペンダントタイプのポイントランプで、埋め込み型も用意しています。発光部は透明のメタクリレート樹脂製。光源はLED(4,5ワット、430ルーメン、3000ケルビン、CRI>90)。筐体の仕上げは、ホワイト半光沢、ブラック半光沢、クロムメッキ。

PINCO 21

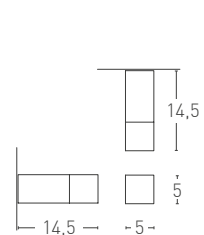

PINCO 21-I

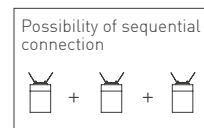
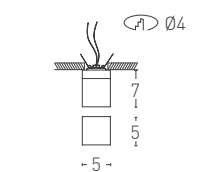

Units: cm

PINCO S

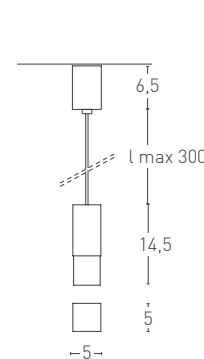

PINCO S-I

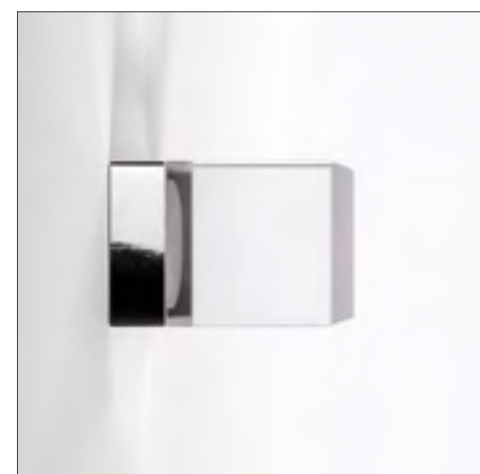
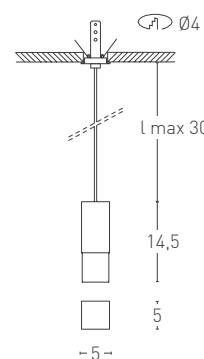

Finishes

- 102 Matt black
- 106 Matt white
- 150 Chrome

Diffuser

PMMA transparent methacrylate

Cable

PINCO S / PINCO S-I
Transparent

Electronic driver

PINCO 21 / PINCO S / PINCO S-I
Included
PINCO 21-I
Not included (250mA 20V)

Light source LED

LED 1x4,5W 220/240V
430lm 3000K CRI>90



Certification

CE EAC IP20 Classe I

PINCO 21-I



PALLINO 21/21-I/S/S-I

Design VillaTosca

PALLINO 21 e PALLINO 21-I, piccoli punti luce da parete o soffitto. La versione 21 è dotata di alimentatore integrato nella base, mentre, la versione 21-I da incasso, può essere fornita con diversi alimentatori remoti a seconda del numero di lampade installate.

PALLINO S e PALLINO S-I, punti luce a sospensione disponibili anche nella versione ad incasso. Diffusore realizzato in metacrilato trasparente. Sorgente luminosa LED da 4,5W 430lm, 3000K, CRI>90. Finiture disponibili: bianco opaco, nero opaco e cromato.

PALLINO 21 and PALLINO 21-I are small wall or ceiling spot lights. The 21 version is equipped with an electronic driver integrated into the base, while the 21-I recessed lighting version can be provided with different remote electronic drivers according to the number of lamps installed.

PALLINO S and PALLINO S-I are pendant spot lights also available in lighting version. Diffuser in transparent methacrylate. LED light source of 4,5W 430lm, 3000K, CRI>90. Finishes: matt white, matt black and chrome.

「パッリーノ21&パッリーノ21-I」は壁や天井に設置する小さなポイントライトです。バージョン「21」はドライバー内蔵型、バージョン「21-I」は埋め込み型でドライバーは必要な照明の数にあわせて別置で設定ができます。

「パッリーノS&パッリーノS-I」はペンダントタイプのポイントランプで、埋め込み型も用意しています。発光部は透明のメタクリレート樹脂製。光源はLED(4,5ワット、430ルーメン、3000ケルビン、CRI>90)。筐体の仕上げは、ホワイ半光沢、ブラック半光沢、クロムメッキ。

PALLINO 21

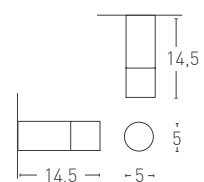

PALLINO 21-I

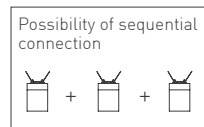
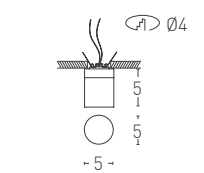

Units: cm

PALLINO S

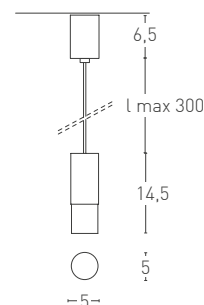

PALLINO S-I

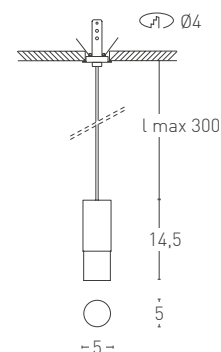

Finishes

- 102 Matt black
- 106 Matt white
- 150 Chrome

Diffuser

PMMA Transparent methacrylate

Cable

PALLINO S / PALLINO S-I
Transparent

Electronic driver

PALLINO 21 / PALLINO S / PALLINO S-I
Included

PALLINO 21-I
Not included (250mA 20V)

Light source LED

LED 1x4,5W 220/240V
430lm 3000K CRI>90



Certification

CE EAC IP20 Classe I

PALLINO 21-I



PALLINO LIP 21/21-I/S/S-I

Design VillaTosca

PALLINO LIP 21 e PALLINO LIP 21-I, piccoli punti luce da parete o soffitto. La versione 21 è dotata di alimentatore integrato nella base, mentre, la versione 21-I da incasso, può essere fornita con diversi alimentatori remoti a seconda del numero di lampade installate.

PALLINO LIP S e PALLINO LIP S-I, punti luce a sospensione disponibili anche nella versione ad incasso. Diffusore realizzato in metacrilato trasparente. Sorgente luminosa LED da 4,5W 430lm, 3000K, CRI>90. Finiture disponibili: bianco opaco, nero opaco e cromato.

PALLINO LIP 21 and PALLINO LIP 21-I are small wall or ceiling spot lights. The 21 version is equipped with an electronic driver integrated into the base, while the 21-I recessed lighting version can be provided with different remote electronic drivers according to the number of lamps installed.

PALLINO LIP S and PALLINO LIP S-I are pendant spot lights also available in recessed lighting. Diffuser in transparent methacrylate. LED light source of 4,5W 430lm, 3000K, CRI>90. Finishes: matt white, matt black and chrome.

「パッリーノ・リップ21」と「パッリーノ・リップ21-I」は壁や天井に設置する小さなポイントライトです。バージョン「21」はドライバー内蔵型、バージョン「21-I」は埋め込み型でドライバーは必要な照明の数にあわせて別置で設定ができます。

「パッリーノ・リップS」と「パッリーノ・リップS-I」はペンダントタイプのポイントランプで、埋め込み型も用意しています。発光部は透明のメタクリレート樹脂製。光源はLED(4,5ワット、430ルーメン、3000ケルビン、CRI>90)。筐体の仕上げは、ホワイト半光沢、ブラック半光沢、クロムメッキ。

PALLINO LIP 21

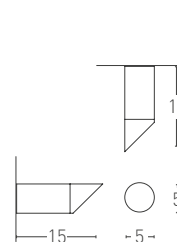

PALLINO LIP 21-I

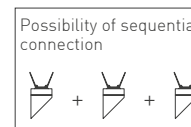
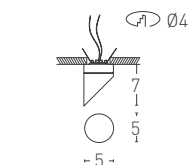

Units: cm

PALLINO LIP S

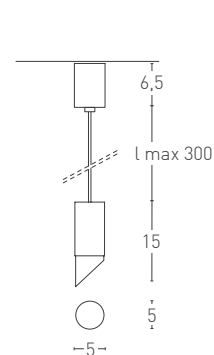

PALLINO LIP S-I

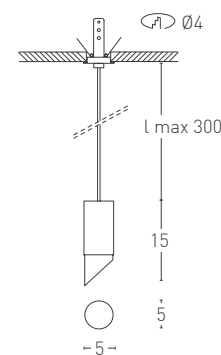

Finishes

- 102 Matt black
- 106 Matt white
- 150 Chrome

Diffuser

PMMA Transparent methacrylate

Cable

PALLINO LIP S / PALLINO LIP S-I
Transparent

Electronic driver

PALLINO LIP 21/ PALLINO LIP S
PALLINO LIP S-I
Included
PALLINO LIP 21-I
Not included (250mA 20V)

Light source LED

LED 1x4,5W 220/240V
430lm 3000K CRI>90



Certification

CE EAC IP20 Classe I

PALLINO LIP 21-I

RAMAGE

Design Enrico Azzimonti

FOGLIE HI-TECH

Prolunga sulle pareti un effimero gioco di luci ed ombre il paralume di RAMAGE, collezione da terra e sospensione che riproduce un lussureggiante fogliame tecnologico. Ogni singola foglia, in metallo tagliato al laser, è modellata manualmente da abili artigiani in grado di creare unici ed irripetibili pezzi dalle organiche forme naturali.

HI-TECH LEAVES

RAMAGE, floor and hanging lamp collection, with its lampshade extends on walls an ephemeral game of light and shadows. It reproduces a lush hi-tech foliage, where each leaf, in laser-cut steel, is shaped by skilled craftsmen who create unique and unrepeatable pieces with natural forms.

ハイテクの木の葉

「ラマーヂュ」は壁に投射されるはかたない光と影の楽しみを生み出すフロアタイプとペンダントタイプのランプです。メタルプレートからレーザーカットされ作り出される木の葉のささやきを感じさせるセード部は熟練の職人の手によって自然な形にボリュームを与えられ、一品ごとが唯一無二の作品となります。

RAMAGE / RAMAGE II

Design Enrico Azzimonti

Lampada a sospensione e da terra con paralume metallico. La doppia sorgente luminosa LED collocata al centro del corpo lampada consente di illuminare sia verso l'alto sia verso il basso, creando un divertente gioco di luci ed ombre. Finiture: bianco opaco, grigio sabbia FT, emerald FT, oxyde FT. Alimentatore elettronico dimmerabile incluso.

Suspension and floor lamp with metallic diffuser. The double LED light source is placed at the center of the body lamp and allows to light up either upwards or downwards, creating a funny game of lights and shadows each light source. Finishes: matt white, sand grey FT, emerald FT, oxyde FT. Dimmable electronic driver included

メタル製セードのペンダントランプ。二重のLED光源を本体の中心に内蔵しております。これによって上部と下部の両方の組み合わせで光と影を楽しむことができます。塗装は、ホワイト半光沢、梨地状のファインテクスチャー（以下FT）FTサンド・グレー、FTエメラルド、FTオレンジの4種類から選択できます。



RAMAGE

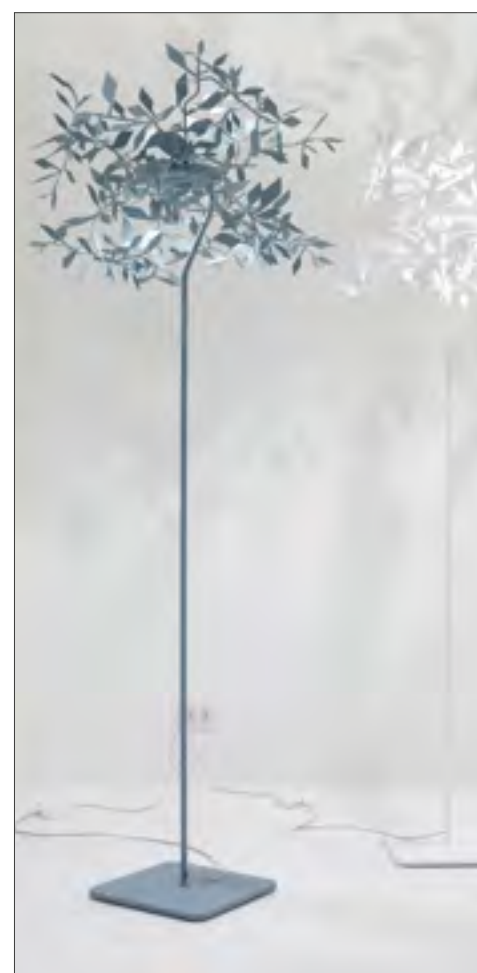
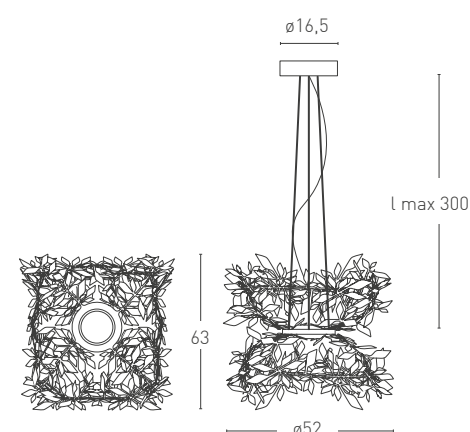

RAMAGE II

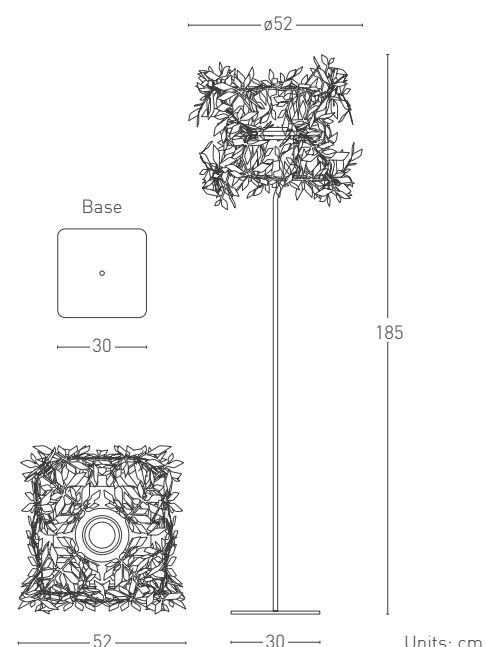

Finishes

- 106 Matt white
- 115R FT Sand grey
- 116FT Emerald
- 117FT Oxyde

Electronic driver

RAMAGE: Dimmable included TRIAC
RAMAGE II: Dimmable included

Light source LED

LED UP - 17,5W 220/240V
1750lm 3000K CRI>90

LED DOWN - 17,5W 220/240V
1750lm 3000K CRI>90



Certification

CE EAC IP20 Classe I



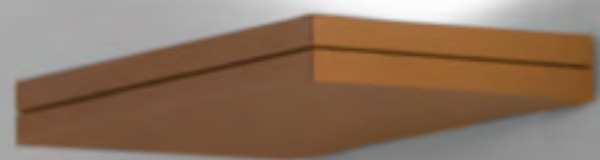

UN CONCENTRATO DI LUCE

SEGNI, famiglia di punti luce a parete caratterizzati dal design estremamente minimale, progettata per ottenere il miglior rendimento luminoso con il minore ingombro e utilizzo di materiale possibile. Il risultato è un concentrato di luce in cui il corpo lampada sparisce sulla parete per dare risalto alle potenzialità dei LED utilizzati. Nuove le versioni orientabili e con doppia sorgente LED (3000K CRI>90).

A CONCENTRATION OF LIGHT

Segni, collection of wall spot lights characterized by an extremely minimal shape, is designed to get the best light output in the smallest amount of space possible. The outcome is a concentrate of light where the lamp body disappears and LED technology stands out. New adjustable versions and with double LED light source (3000K CRI>90).

光の結晶

「セーニ」は、ミニマルデザインの極限を再現したウォールランプでのシリーズ、必要最小限のサイズと材料の消費で最大限の効果を発揮できる照明を目指してデザインされました。その結果としてLED光源(3000ケルビン、CRI>90)の性能を光の結晶として最大限に活用することでランプ自体がまるで壁に溶け込んでしまった様な印象を創り出すことが出来ました。シリーズには新たに照射角度自在式タイプと上下二重光源内蔵タイプが加わりました。

SEGNI QUADRO/RETTO/TONDO/TRINO

Design VillaTosca

SEGNI è la collezione di piccoli punti luce a parete che esalta le potenzialità dei LED utilizzati, rendendo minimo l'ingombro e l'utilizzo di materiale del corpo lampada. Disponibili nelle finiture: bianco fine textured, nero fine textured, oxyde fine textured e grigio perla. Utilizzano sorgenti LED da 10W, 3000K e resa luminosa da 780lm.

SEGNI is the collection of small wall spot lights, that emphasizes the potential of the LED used, in a minimum amount of space and with the smallest use of materials for the lamp body. Available in the following finishes: white fine textured, black fine textured, oxyde fine textured and pearl grey. LED light source 10W 3000K, 780lm.

「セーニ」は、ミニマルデザインの極限を再現したウォールランプで、必要最小限のサイズと材料の消費で最大限の効果を発揮できる照明を目指してデザインされました。塗装は、梨地状のファインテクスチャー（以下FT）FTホワイト、FTブラック、FTオレンジ、FTパール・グレーが用意されています。LEDは10ワット、3000ケルビン、780ルーメン。

SEGNO QUADRO

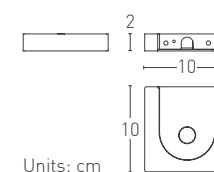

SEGNO TONDO

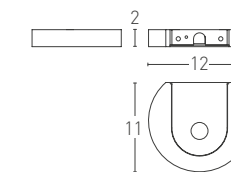

SEGNO RETTO

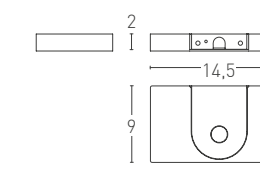

SEGNO TRINO

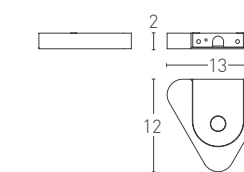

Units: cm



Finishes

- 103FT Black
- 105FT White
- 117FT Oxyde
- 123 Pearl grey

Electronic driver

LED Light Engine dimmable TRIAC

Light source LED

LED 10W 220/240V
780lm 3000K CRI>90



Certification

CE EAC F Classe I IP20



SEGNI GIRO QUADRO/TONDO

Design VillaTosca

Collezione di punti luce a parete con diffusore orientabile di 340°. Disponibili nelle finiture bianco fine textured, nero fine textured, oxyde fine textured e grigio perla. Sorgente LED da 10W, 3000K, 780lm, CRI>90.

Collection of wall spot lights with adjustable diffuser of 340 degrees. Available in the following finishes: FT white, FT black, FT oxyde, pearl grey. LED light source 10W 3000K, 780lm CRI>90.

取り付け中心から340度の角度で本体の向きを変えることの出来るウォールタイプのポイントライトシリーズ。塗装は梨地状のファインテクスチャー(以下FT)FTホワイト、FTブラック、FTオレンジ、FTパール・グレイが用意されています。

LEDは10ワット、3000ケルビン、780ルーメン、CRI>90。

SEGNO GIRO QUADRO

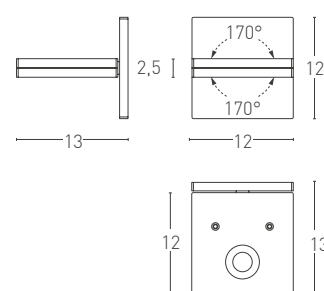

SEGNO GIRO TONDO

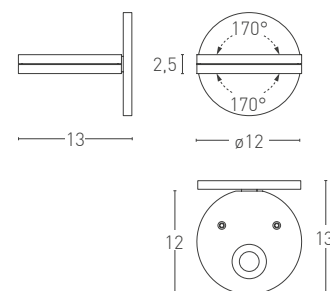

Units: cm



Finishes

- 103FT Black
- 105FT White
- 117FT Oxyde
- 123 Pearl grey

Electronic driver

LED Light Engine dimmable TRIAC

Light source LED

LED 10W 220/240V
780lm 3000K CRI>90



Certification

CE EAC F Classe I IP20

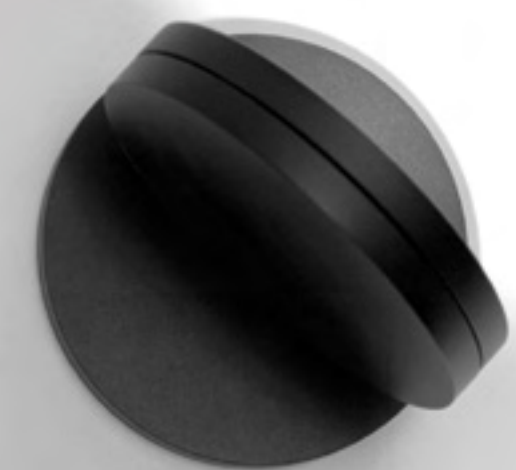

SEGNI MAXI QUADRO/RETTO/DOUBLE

Design VillaTosca

Punti luce a parete dall'elevata potenza luminosa. Disponibili nelle finiture bianco fine textured, nero fine textured, oxyde fine textured e grigio perla. Sorgente LED da 20W, 3000K, 1560lm, CRI>90. Disponibile anche nella versione MAXI DOUBLE con doppia sorgente luminosa collocata nella parte superiore e inferiore del corpo lampada.

High luminous intensity wall spot lights. Available in the following finishes: FT white, FT black, FT oxyde, pearl grey. LED light source 20W, 3000K, 1560lm CRI>90. The MAXI DOUBLE version has double light source located both in the upper and lower part of the lamp body.

強力的な光を生むウォールタイプのポイントライト。塗装は梨地状のファインテクスチャー(以下FT)FTホワイト、FTブラック、FTオレンジ、FTパール・グレーが用意されています。

LEDは20ワット、3000ケルビン、1560ルーメン、CRI>90。「マキシ・ダブル」のバージョンは二重光源を持ち上部と下部を同時に照らすことが出来ます。



Finishes

- 103FT Black
- 105FT White
- 117FT Oxyde
- 123 Pearl grey

Electronic driver

LED Light Engine dimmable TRIAC

Light source LED

LED 20W 220/240V

SEGNO MAXI QUADRO
1560lm 3000K CRI>90

SEGNO MAXI RETTO
1560lm 3000K CRI>90

SEGNO MAXI DOUBLE

LED Up: 20W 1560lm 3000K CRI>90

LED Down: 10W 780lm 3000K CRI>90



Certification

CE EAC F Classe I IP20



SEGNO MAXI QUADRO

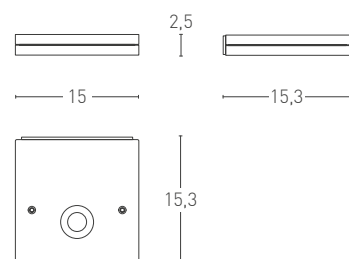

SEGNO MAXI RETTO

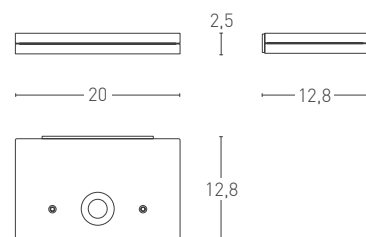

SEGNO MAXI DOUBLE

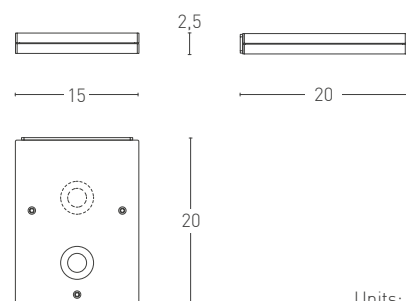

Units: cm



SKYLINE

Design Francesco Giannattasio

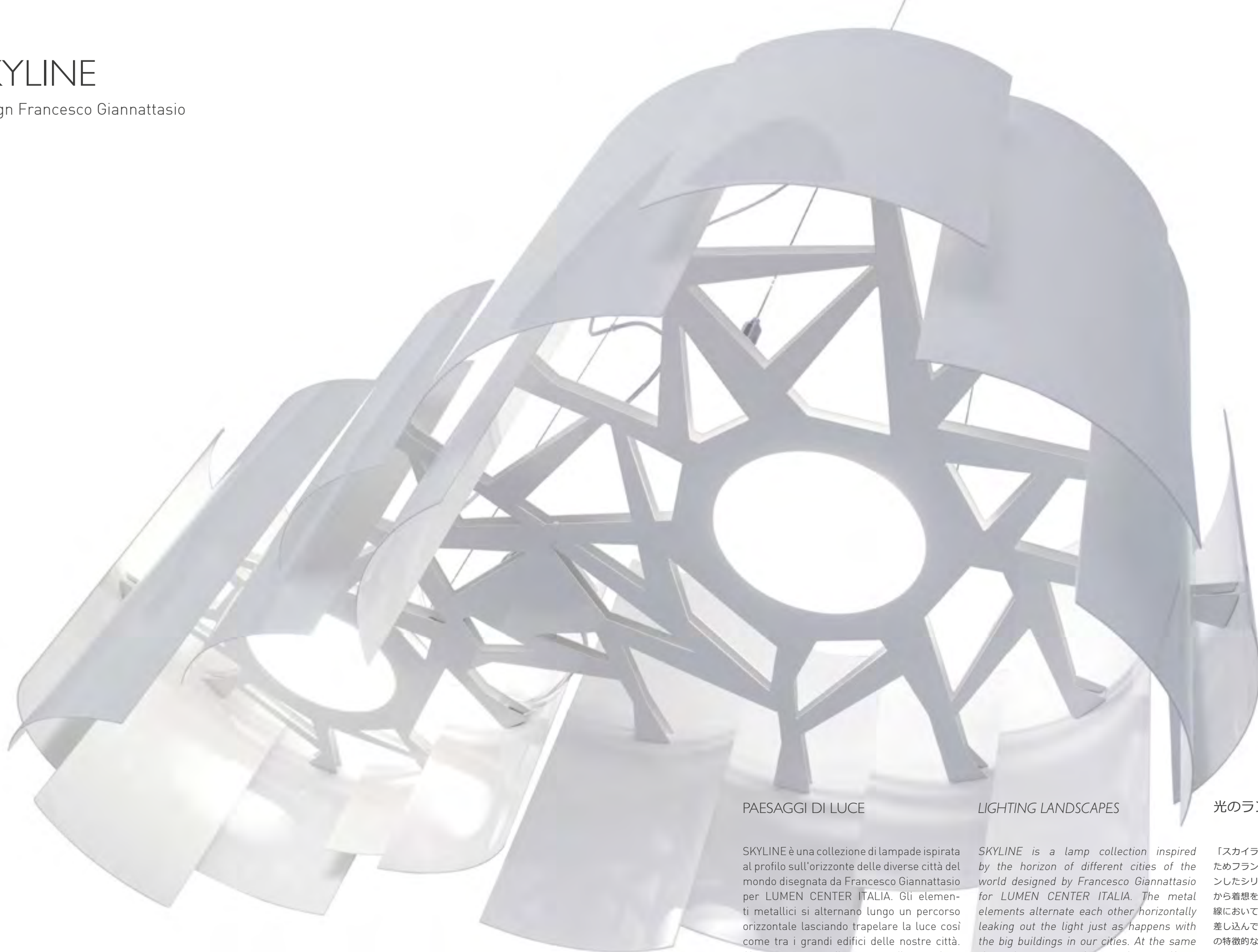

PAESAGGI DI LUCE

SKYLINE è una collezione di lampade ispirata al profilo sull'orizzonte delle diverse città del mondo disegnata da Francesco Giannattasio per LUMEN CENTER ITALIA. Gli elementi metallici si alternano lungo un percorso orizzontale lasciando trapelare la luce così come tra i grandi edifici delle nostre città. Al tempo stesso, il concetto di protezione si manifesta dalle sue forme per trasferirsi nell'ambiente domestico attraverso l'altissima qualità della luce emessa.

LIGHTING LANDSCAPES

SKYLINE is a lamp collection inspired by the horizon of different cities of the world designed by Francesco Giannattasio for LUMEN CENTER ITALIA. The metal elements alternate each other horizontally leaving the light leaking out just as happens with the big buildings in our cities. At the same time, the concept of protection manifests itself from its shapes and transfers itself to the domestic environment through the high quality of the light it produces.

光のランドスケープ

「スカイライン」は、ルーメンセンター・イタリアのためフランチェスコ・ジャンナッターズィオがデザインしたシリーズです。異なった町の水平線のシェープから着想を得たもので、メタル製のエレメントが水平線において交錯することで大きなビル谷間から光が差し込んでくるように光が漏れてきます。同時に、その特徴的な幾枚もの、まるで光を遮るかのように配置されたセードの隙間から漏れて放出される光は最高に美しい環境を室内にもたらしてくれるでしょう。

SKYLINE / SKYLINE S / SKYLINE 21

Design Francesco Giannattasio

SKYLINE, lampada a sospensione, utilizza sorgenti luminose alogene ECO Energy Saver da 230W. Disponibile in due misure: l max 49 cm oppure l max 91 cm con doppia sorgente. SKYLINE 21, lampada a parete utilizza una sorgente luminosa alogene ECO Energy Saver da 160W. Realizzate in metallo laccato bianco lucido.

SKYLINE, suspension lamp uses halogen light ECO Energy Saver sources of 230W. Available in two sizes: l max 49 cm or l max 91 cm with double light source. SKYLINE 21, wall lamp it uses halogen light ECO Energy Saver bulb of 160W. Made of lacquered glossy white metal.

「スカイライン」はメタル製のペンダントランプ。エコハロゲン・エナジーセーバー230ワットを使用。サイズは、幅49 cmと二重光源の91 cmの二種類から選択できます。「スカイライン 21」はメタル製のフロアランプ。エコハロゲン・エナジーセーバー160ワットを使用。共にツヤありのホワイト塗装仕上げ。



Finishes

- 114 Glossy white

Cable

Transparent

Suggested light source

R7s Linear Halogen ECO 114,2 mm

SKYLINE 2x230W
SKYLINE S 1x230W
SKYLINE 21 1x160W

Certification

CE EAC F Classe I IP20

SKYLINE

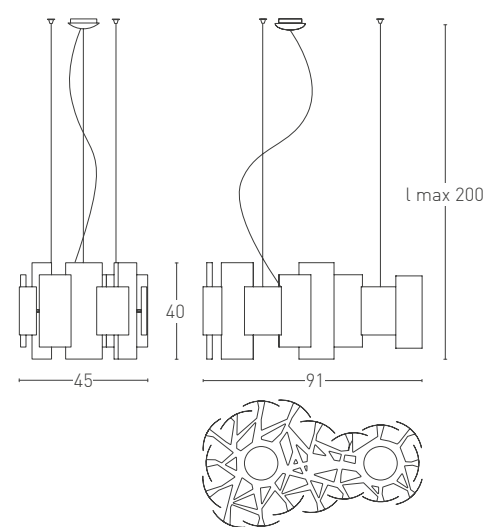

SKYLINE S

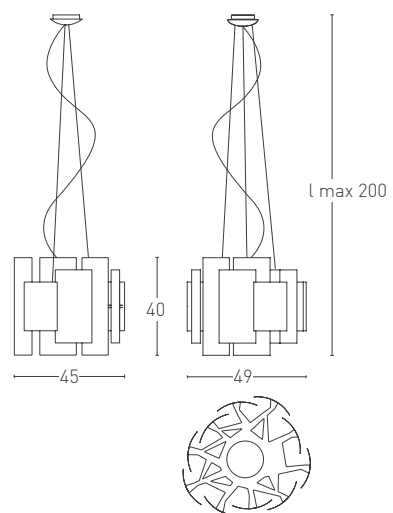

SKYLINE 21

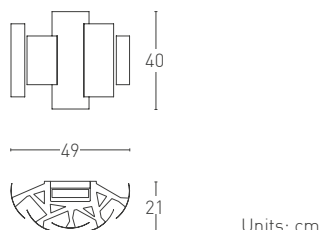

Units: cm

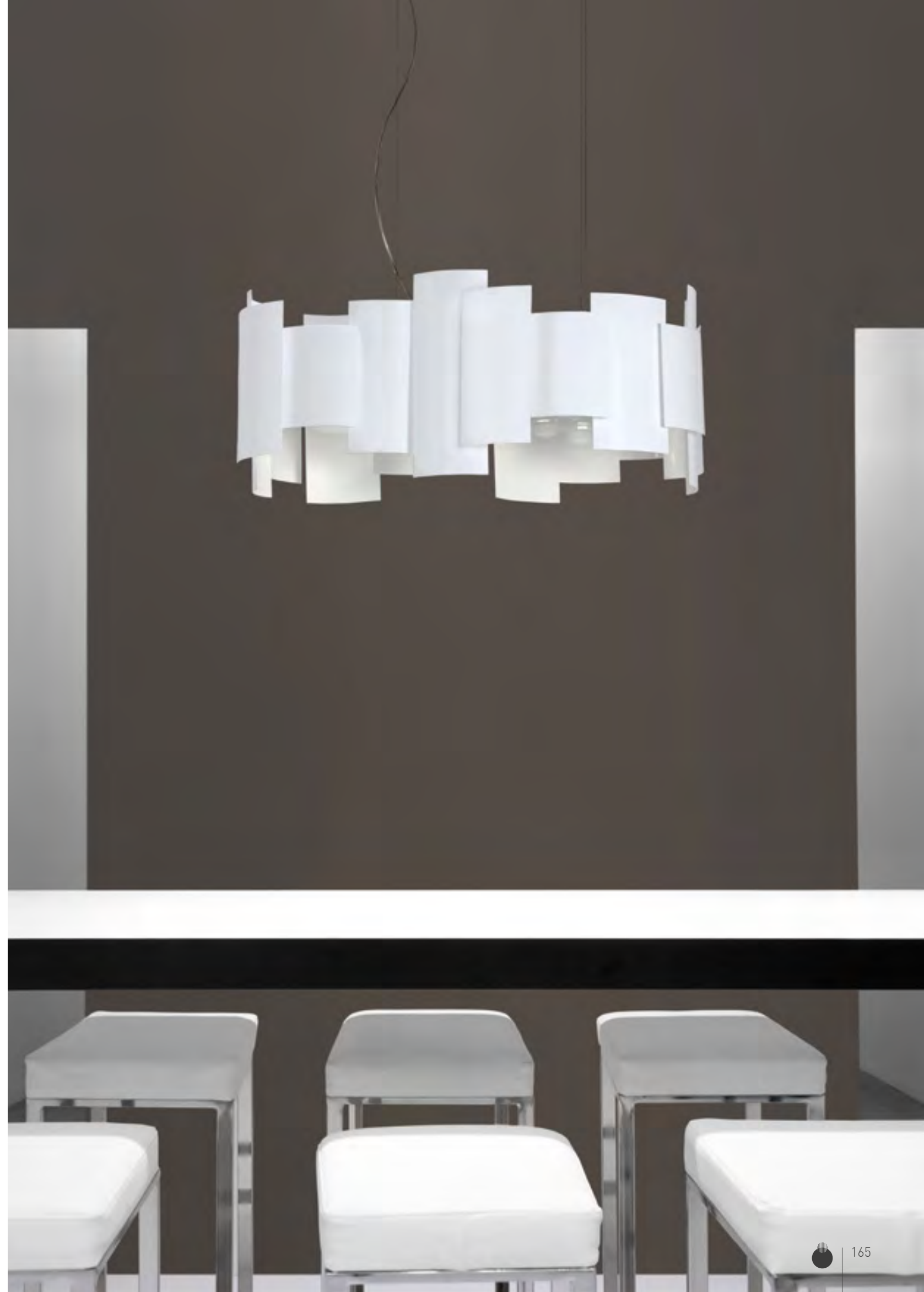

SUMO COLLECTION

Design VillaTosca

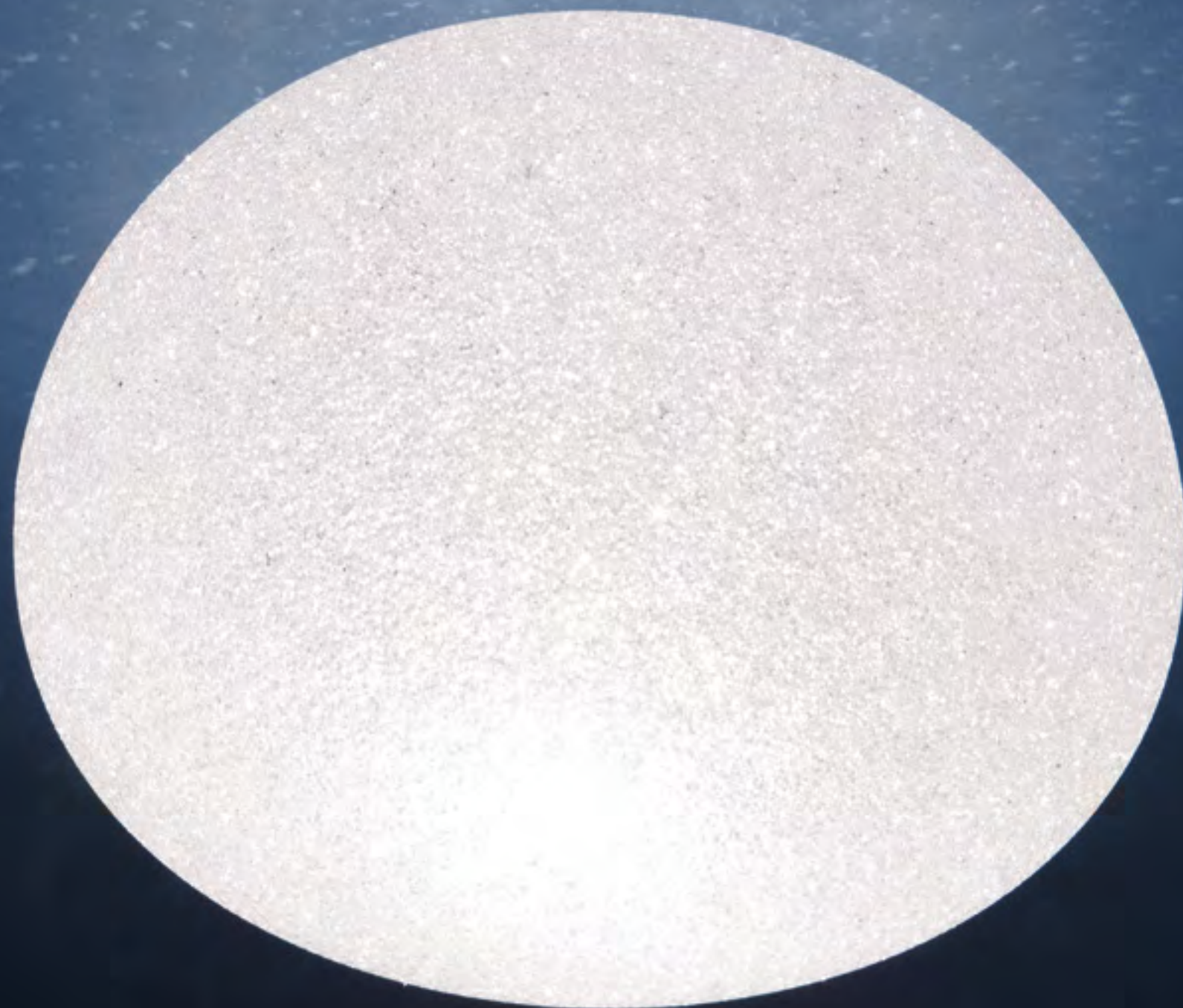

LUCE DALL'ORIENTE

Metaforicamente ispirate alle forme del corpo dei lottatori di Sumo, la divertente collezione di sospensioni, applique e lampade da terra con diffusore in policarbonato microforato è disponibile in varie tipologie e dimensioni. Attacco E27, finitura delle strutture bianco opaco.

LIGHT FROM THE FAR EAST

Metaphorically inspired to Japanese wrestlers body, this funny collection of suspensions, wall and floor lamps with micropunched polycarbonate diffuser, is available in different sizes and typologies. Socket E27, matt white frame finish.

東洋からの光

相撲の力士の体型にヒントを得たユニークなシリーズ。ビーズ状のポリカーボネートを成型し作られたグローブは大小さまざまなサイズを持ち、用途もシーリング/ウォール、ペンダント、フロアと幅広い用途でお選び頂けます。電球金口はE27。筐体の仕上げはホワイト半光沢。

SUMO S/M/L/X

Design VillaTosca

Sospensioni in policarbonato microforato, realizzate in tre forme e 4 differenti diametri. Rosone realizzato in ABS bianco opaco.

Suspension lamps in micropunched polycarbonate, three sizes and 4 different diameters. Ceiling rose in matt white ABS.

ピース状のポリカーボネート製グローブのペンダントランプ、3種類の形状から成る4つのサイズ構成。フランジはABS製（色/ホワイト半光沢）。

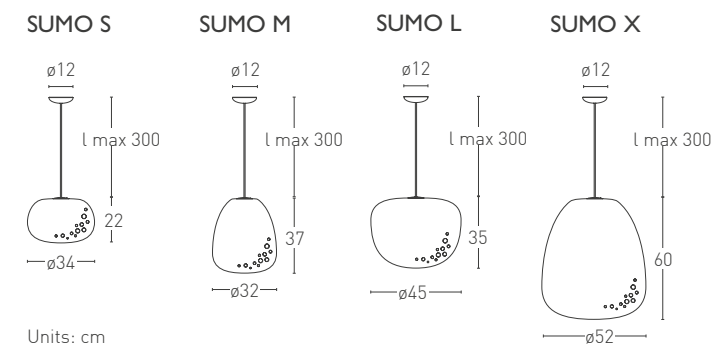

Finishes

○ ABS White

Diffuser

PC Polycarbonate

Cable

Transparent

Suggested light source

SUMO S

E27 Halogen ECO max 1x77W

E27 ECO Fluo max 1x11W

SUMO M/L

E27 Halogen ECO max 1x77W

E27 ECO Fluo max 1x24W

SUMO X

E27 Halogen ECO max 1x116W

E27 ECO Fluo max 1x24W

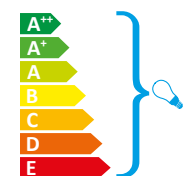

Certification

CE EAC PS E F IP20



SUMO 21/M21/L21

Design VillaTosca

Applique e plafoniere in policarbonato microforato. Attacco realizzato in metallo verniciato bianco opaco.

Wall and ceiling lamps in micropunched polycarbonate. Metal frame is powder coated in matt white.

ビーズ状のポリカーボネート製グローブのシーリング/ウォールランプ。スチール製の筐体はホワイト半光沢の塗装仕上げ。

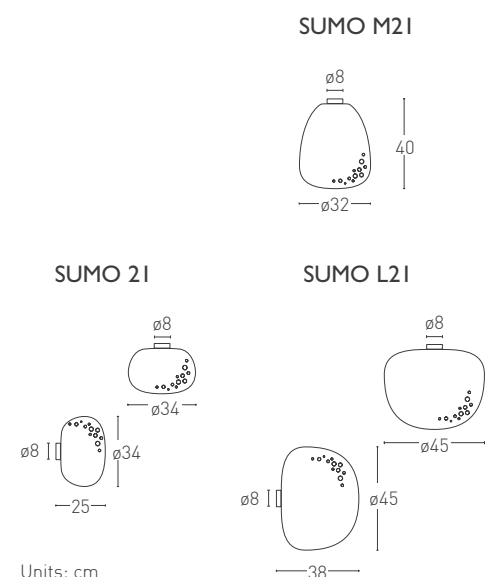

Finishes

- 106 Matt white

Diffuser

PC Polycarbonate

Suggested light source

SUMO 21

E27 Halogen ECO max 1x77W

E27 ECO Fluo max 1x11W

SUMO M21

E27 Halogen ECO max 1x77W

E27 ECO Fluo max 1x24W

SUMO L21

E27 Halogen ECO max 1x77W

E27 ECO Fluo max 1x24W

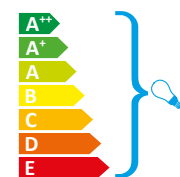

Certification

CE EAC PS E F Classe I IP20

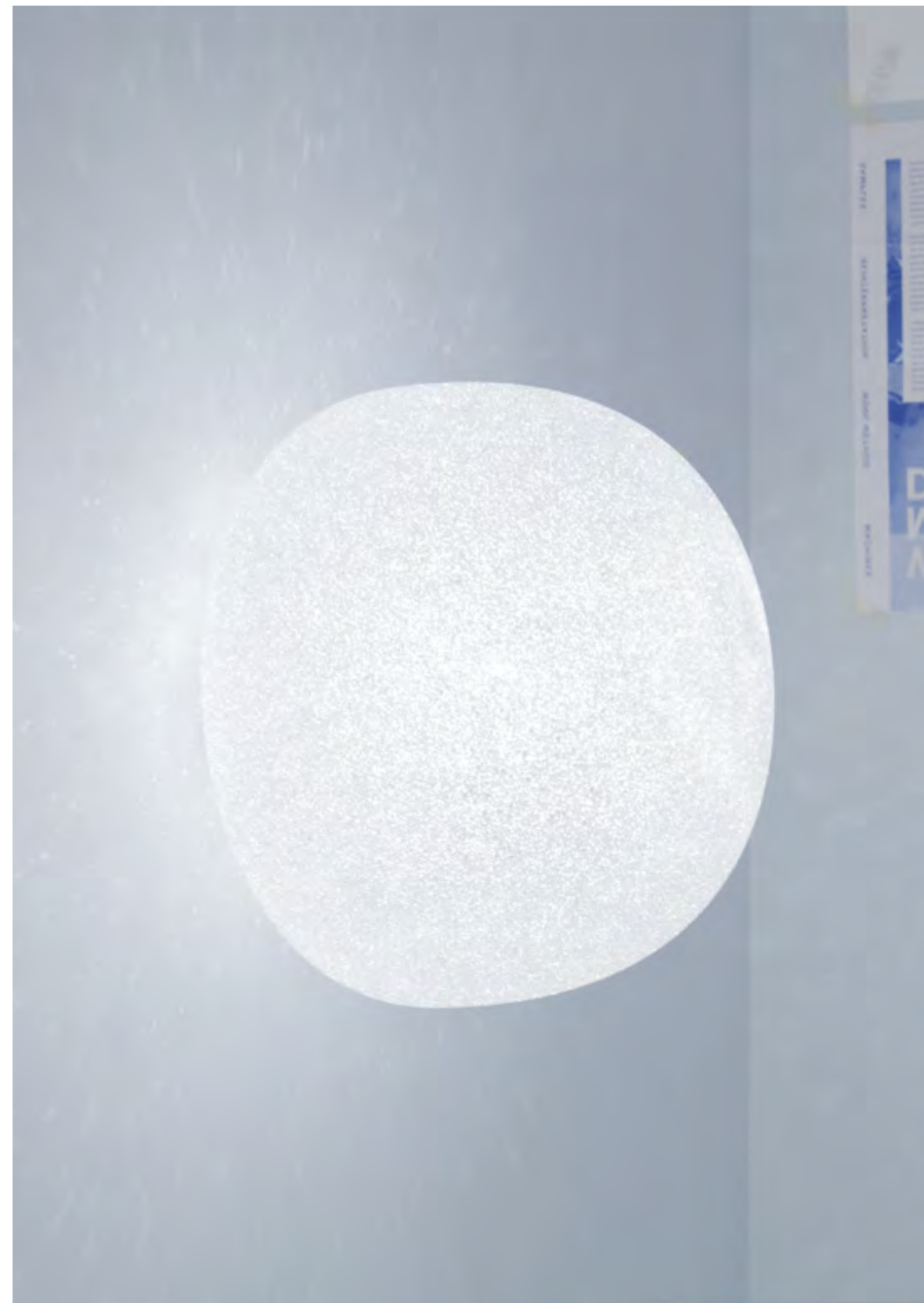

SUMO M11/M12

Design VillaTosca

Lampade da terra con diffusore in policarbonato microforato. Stelo e base realizzati in metallo verniciato bianco opaco. Regolatore di intensità luminosa incluso.

Floor lamps with diffuser in micropunched polycarbonate. Metal frame is powder coated in matt white. Dimmer included.

ピース状のポリカーボネート製グローブのフロアランプ。スチール製の筐体はホワイト半光沢の塗装仕上げ。調光機能付き。

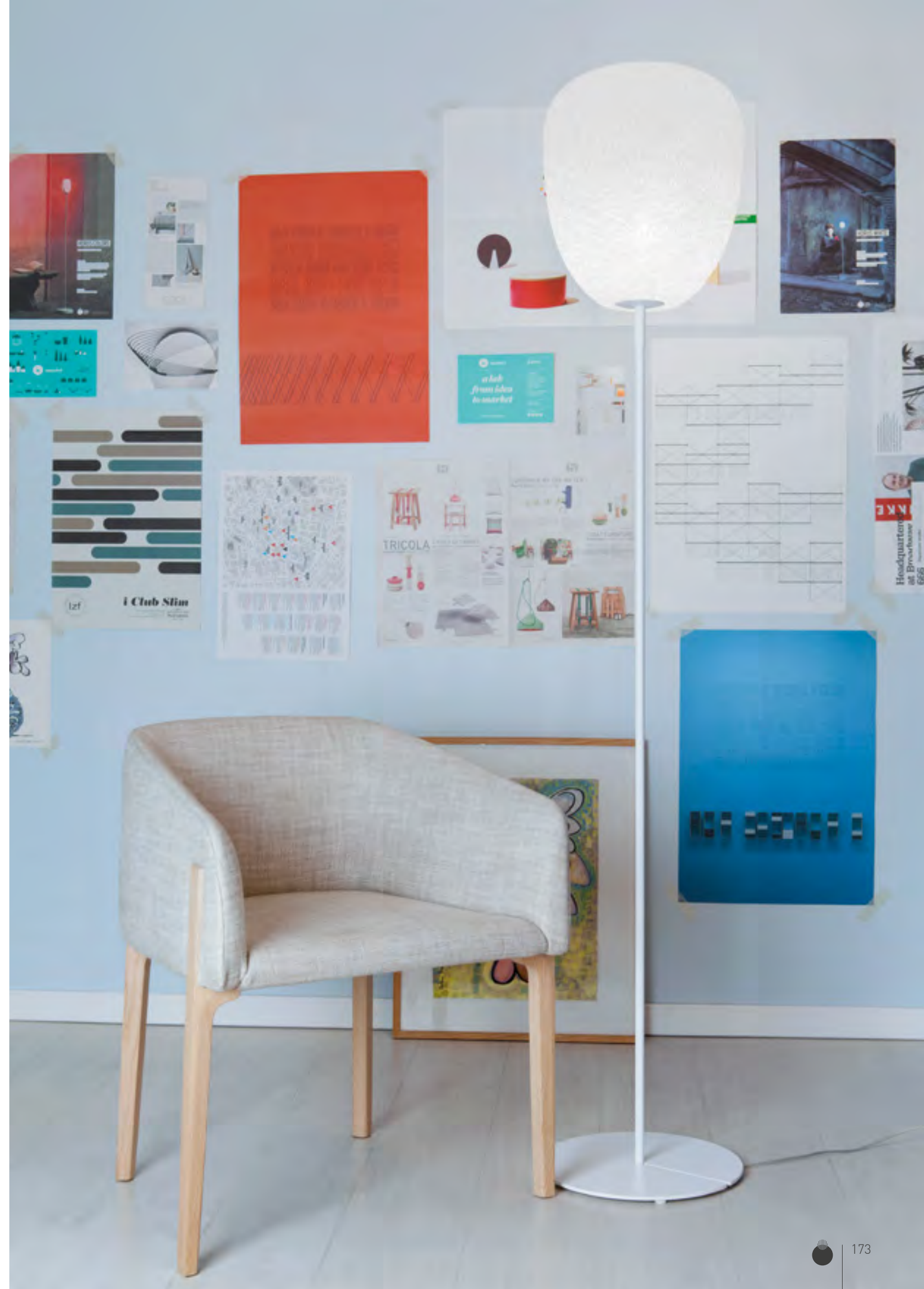

Finishes

○ 106 Matt white

Diffuser

PC Polycarbonate

Dimmer

Included

Suggested light source

 E27 Halogen ECO
max 1x116W

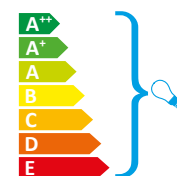

Certification

     IP20

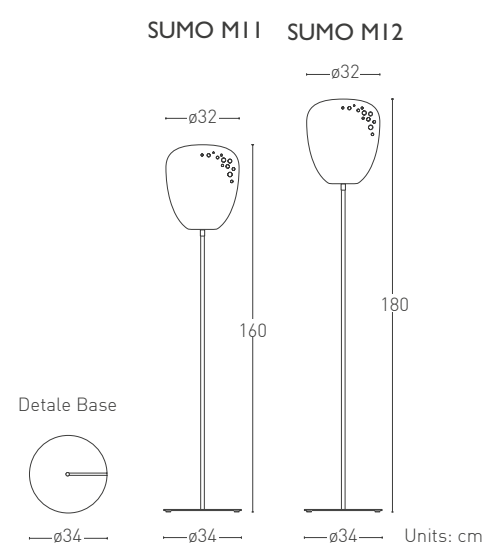

SUMO 02/M02/L02/X02

Design VillaTosca

Lampade da tavolo realizzate in policarbonato microforato. Base realizzata in metallo verniciato bianco opaco. Regolatore di intensità luminosa incluso.

Table lamps in micropunched polycarbonate. Metal frame is powder coated in matt white. Dimmer included.

ピース状のポリカーボネート製グローブのテーブルランプ。スチール製の筐体はホワイト半光沢の塗装仕上げ。調光機能付き。

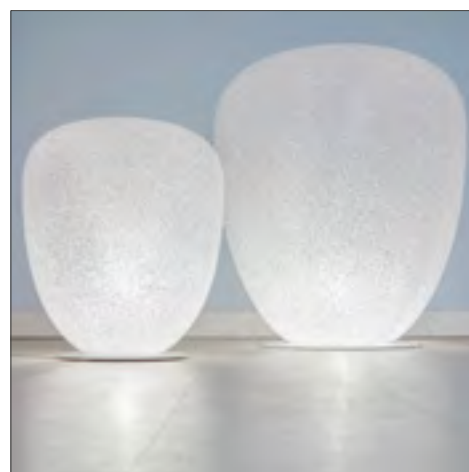
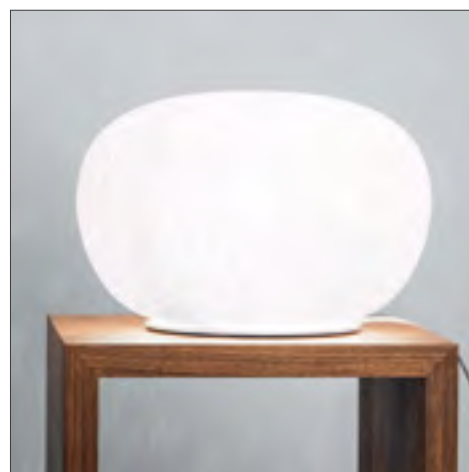
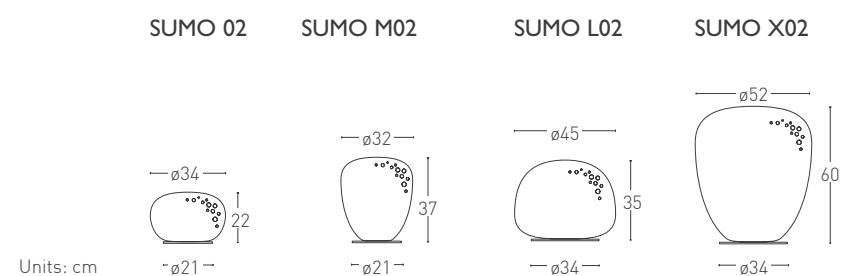

Finishes

○ 106 Matt white

Diffuser

PC Polycarbonate

Dimmer

SUMO L02 / X02 Included

Suggested light source

SUMO 02

☞ E27 Halogen ECO max 1x77W

☞ E27 ECO Fluo max 1x11W

SUMO M02/L02

☞ E27 Halogen ECO max 1x77W

☞ E27 ECO Fluo max 1x24W

SUMO X02

☞ E27 Halogen ECO max 1x116W

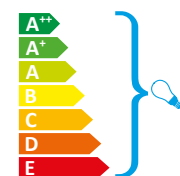

Certification



TAKÉ PLUS COLLECTION

Design VillaTosca

NEW
TECHNO
LOGY

ECOSISTEMI DI LUCE

TAKÉ PLUS è la linea di lampade, a sorgente luminosa LED, caratterizzata dalla grande flessibilità d'uso e personalità estetica. Grazie ad un progetto che ne ottimizza l'assemblaggio e processo produttivo, sono nate 7 diverse tipologie di prodotto in grado di rispondere alle diverse esigenze di illuminazione sia di ambienti domestici che di grandi spazi retail o di intrattenimento, garantendo sempre un elevato standard di qualità della luce.

Le versioni da Terra (da 04 a 06 e OVAL) e S&P, vengono fornite con i nuovi driver a controllo della dimmerazione diretta tramite pulsante integrato nell'alimentatore o tramite App per sistemi operativi iOS e Android. Le versioni a Sospensione sono previste con accensione ON-OFF, a richiesta dimmer integrato nell'alimentatore con controllo della funzione PUSH o tramite App per sistemi operativi iOS e Android.

LIGHT ECOSYSTEM

TAKÉ PLUS is the lamp collection equipped with LED light sources, characterized by a great versatility and personality. Thanks to a process that optimizes assembly and productive process, this collection has built up 7 different types of products to meet the diverse needs of lighting: from the most intimate spaces of home, to major retail and entertainment spaces, always ensuring a high standard of quality of light.

In standard equipment for ground versions (from 04 to 06 and OVAL) and S&P, new drivers with direct control of dimming via dimmer or via App for iOS and Android operating systems.

The suspension version are provided with ON-OFF switch, by request integrated dimmer in the power supply with control of PUSH function or via App for iOS and Android operating systems.

ライティング・エコシステム

「タケ・プラス」はLED光源を内蔵した様々な使い方ができる個性的なデザインを特徴としたランプのシリーズです。

組み立て及び製造工程を最適化したデザインから7種類のタイプが生まれました。これによって、「高い水準の光のクオリティー」を保持しながら家庭的な環境から商空間に至るまで幅広いニーズにこたえることができます。

フロアタイプ (04, 05, 06、オーバル)、S & Pタイプには新たに照明本体から調光する機能に加え、スマートフォン (iOSおよび Android) 等からAppを通じて調光可能な機能も搭載しました。ペンダントタイプの「オン/オフ」シリーズもオプションで同機能をお選びいただけます。

TAKÉ PLUS TOUCH 01

Design VillaTosca

TAKÉ PLUS Touch 01 è la versione da tavolo della serie: costituita da un solo elemento illuminante, ha una resa luminosa di 1100lm ed una potenza di 16W. È dotato di touch dimmer per l'accensione e variazione dell'intensità luminosa. Il diffusore è realizzato in Polietilene (PE) bianco opale. Le finiture disponibili per le basi sono: cromato e bianco opaco.

TAKÉ PLUS Touch 01 table version made of one lighting module; it has a light output of 1100 lm and a power of 16W. It is equipped with touch dimmer for starting and luminous intensity variation. The diffuser is made of opal white Polyethylene (PE). Bases available in the following finishes: chrome and matt white.

「タケ・プラス タッチ01」は「タケ」シリーズのテーブルランプです。発光部は一つのモジュールで構成され、16ワット/1100ルーメンの出力/明るさを有します。ランプの上部には電源ボタンがあり、同じ部分を操作することで調光が可能です。グローブはポリエチレン(PE)製(色/オパール・ホワイト)。筐体の仕上げはクロムメッキとホワイト半光沢。



Finishes

- 106 Matt white
- 150 Chrome

Diffuser

PE Polyethylene opal white

Cable

Transparent

Electronic driver

Dimmable included

Light source

LED

LED 16W 220/240V
1100lm 3000K CRI>90

A

Certification

CE EAC PSE F Classe I IP20

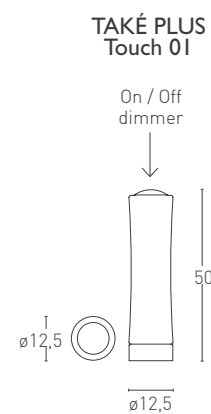

Units: cm

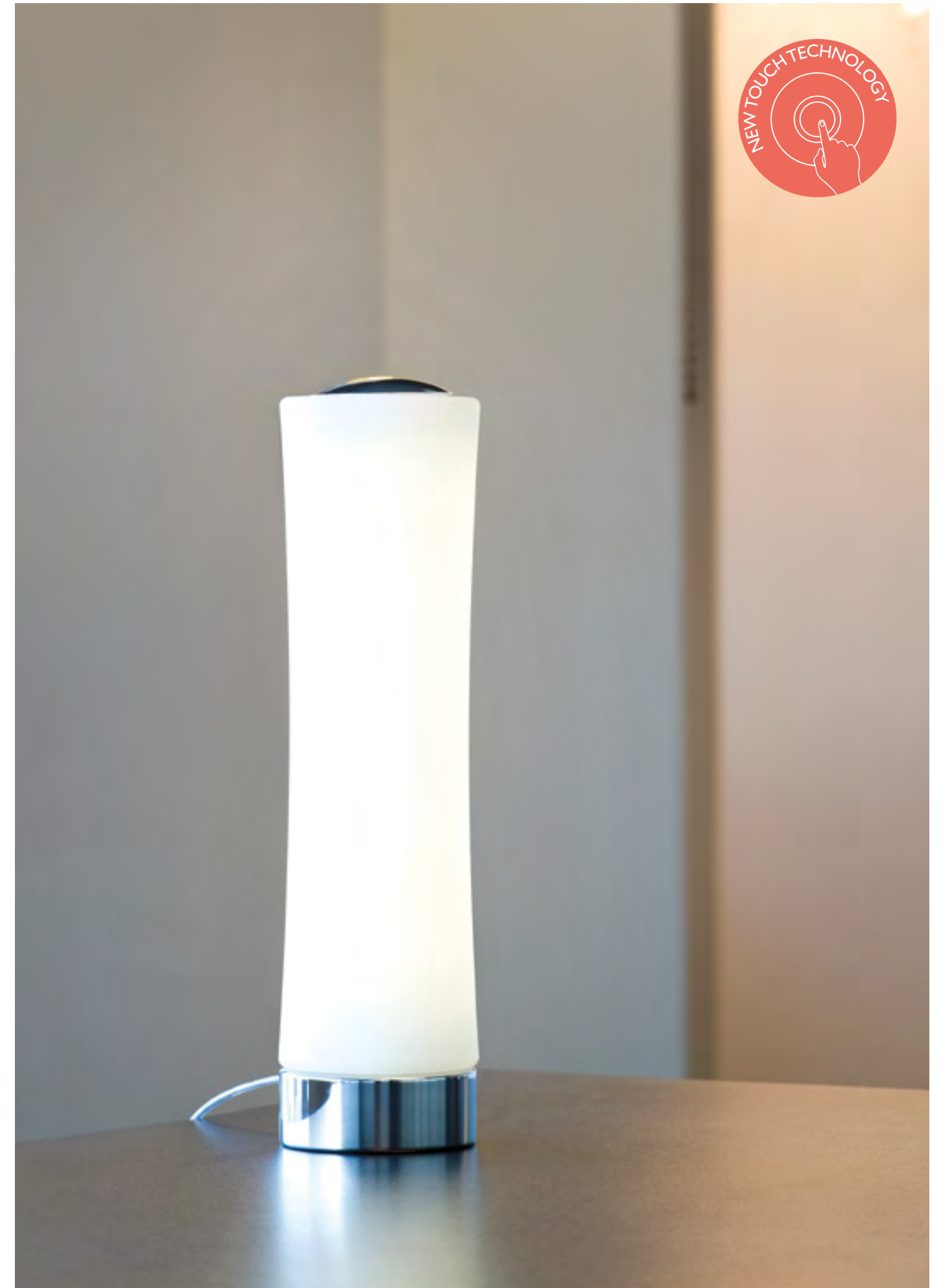

TAKÉ PLUS TOUCH 02/03

Design VillaTosca

TAKÉ PLUS Touch 02 e 03 rappresentano le versioni da "conversazione" rispettivamente a 2 e 3 elementi. Sono dotate di touch dimmer per l'accensione e variazione dell'intensità luminosa. Il diffusore, è realizzato in Polietilene (PE) bianco opale. Le finiture disponibili per le basi sono: cromato e bianco opaco.

TAKÉ PLUS Touch 02 and 03 are the "conversation" versions made of 2 and 3 sections. They are equipped with touch dimmer for starting and luminous intensity variation. The diffuser is made of opal white Polyethylene (PE). Bases available in the following finishes: chrome and matt white.

「タケ・プラス タッチ02」と「タッチ03」は2つ及び3つのモジュールから構成される、会話のしやすい落ち着いた雰囲気演出に向けたフロアタイプのランプです。ランプの上部には電源ボタンがあり、同じ部分を操作することで調光が可能です。グローブはポリエチレン(PE)製(色/オパール・ホワイト)。筐体の仕上げはクロムとホワイト半光沢。

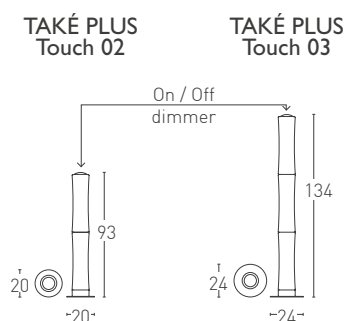

Units: cm



Finishes

- 106 Matt white
- 150 Chrome

Diffuser

PE Polyethylene opal white

Cable

Transparent

Electronic driver

Dimmable included

Light source

LED

LED 220/240V

TAKÉ PLUS Touch 02 32W
2200lm 3000K CRI>90

TAKÉ PLUS Touch 03 48W
3300lm 3000K CRI>90



Certification

CE EAC PS E F Classe I IP20

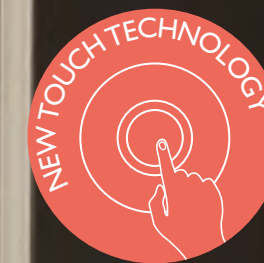

TAKÉ PLUS BT 04/05/06

Design VillaTosca

Lampade da terra, disponibili in tre differenti altezze a seconda degli elementi utilizzati (4, 5 o 6). Dotata di regolatore di intensità luminosa, la lampada diffonde una luce intensa e uniforme lungo tutto il diffusore realizzato in PE bianco opale. Ogni elemento utilizza una sorgente luminosa LED da 16W a temperatura colore prossimale di 3000K.

In dotazione standard nuovi driver con controllo della dimmerazione diretta tramite dimmer a pedale o tramite App per sistemi operativi iOS e Android.

La base e il dimmer a pedale sono di metallo e disponibili in finitura bianco opaco o cromato.

Floor lamp in three different heights according to the used sections (4, 5 or 6). The lamp - equipped with a lighting dimmer - diffuses an intense and uniform light along the whole diffuser made of opal white PE. Each module has a 16W LED lighting source with 3000K colour temperature.

In standard equipment new drivers with direct control of dimming via pedal dimmer or via App for iOS and Android operating systems.

The base and the pedal dimmer are made of metal and available in matt white or chrome finish.

このフロアタイプのバージョンでは、モジュールの使用数（4、5、6）によって3つの高さのバリエーションがあります。調光器付き。ランプは、オパール・ホワイト仕上げのポリエチレン製のグローブ全体を通して全体的にくっきりとした光を広げます。各モジュールは、16ワットのLED光源を内蔵しており、色温度は約3000ケルビン。調光機能については、従来の照明本体から直接操作するものに加え、新たにスマートフォン（iOSおよび Android）等からAppを通じて調光可能な機能も搭載しました。照明ベースと調光装置ともなるアダプターは金属製で塗装は、ホワイト半光沢、クロムの二種類があります。

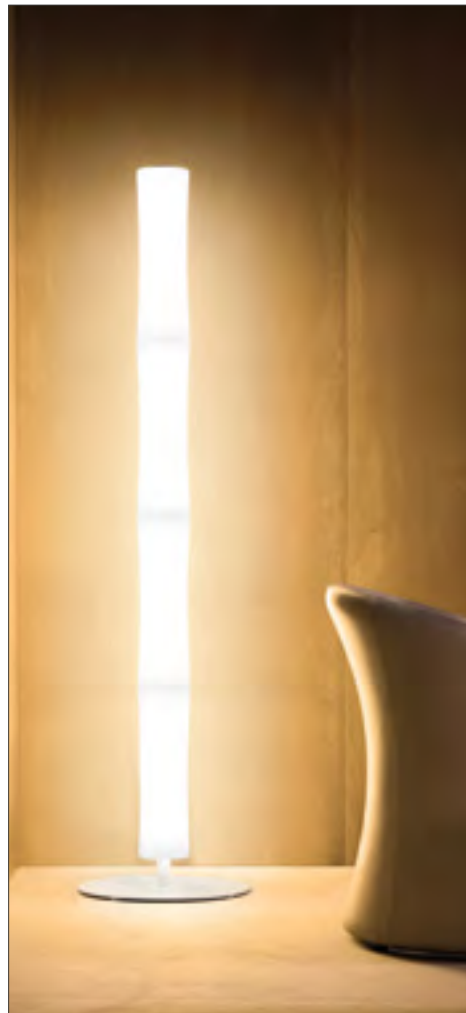
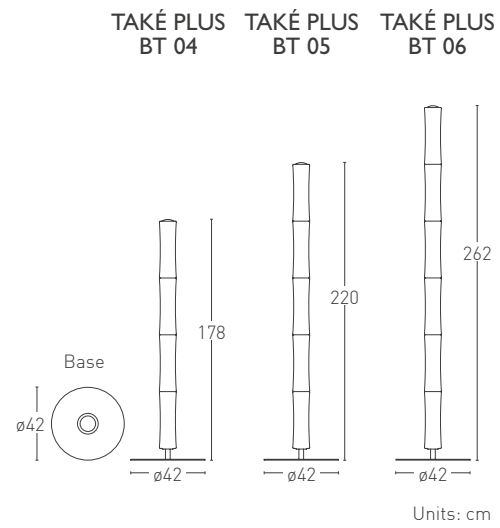

Finishes

- 106 Matt white
- 150 Chrome

Diffuser

PE polyethylene opal white

Cable

Transparent

Electronic driver

Dimmable included

Dimmer

Pedal dimmer and Bluetooth control App for Android and iOS systems

Light source

LED

LED 220/240V

TAKÉ PLUS BT 04 64W
4400lm 3000K CRI>90

TAKÉ PLUS BT 05 80W
5500lm 3000K CRI>90

TAKÉ PLUS BT 06 96W
6600lm 3000K CRI>90

A

Certification

CE EAC PS E F Classe I IP20

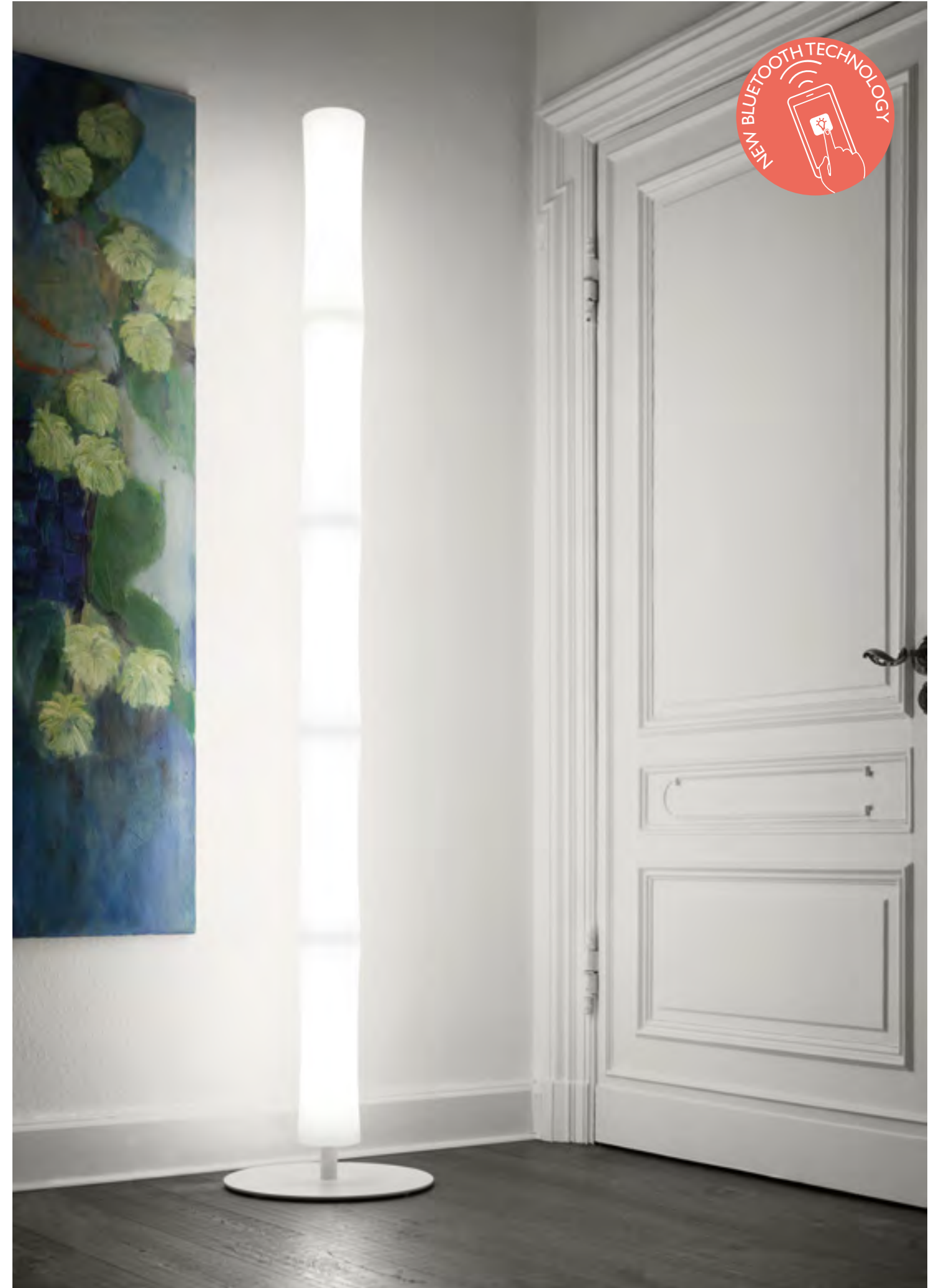

TAKÉ PLUS BT OVAL 05/06

Design VillaTosca

TAKÉ PLUS BT OVAL, lampada da terra con stelo inclinato di 12° su base ovale composta da 5 o 6 elementi. La sorgente LED utilizzata ha temperatura colore di 3000K e diffonde uniformemente la luce lungo tutto l'elemento diffusore in PE. Le potenze variano da 80W per il modello a 5 moduli a 96W per il modello a 6 moduli.

In dotazione standard nuovi driver con controllo della dimmerazione diretta tramite dimmer a pedale o tramite App per sistemi operativi iOS e Android.

La base e il dimmer a pedale sono di metallo e disponibili in finitura bianco opaco o cromato.

TAKÉ PLUS B OVAL, floor lamp with a 12° inclined stem, on an oval base, made of 5 or 6 sections. The LED light source has a 3000K colour temperature and diffuses uniformly the light along the whole PE diffuser. The lighting powers vary from 80W for the 5 sections model to 96W for the 6 sections model.

In standard equipment new drivers with direct control of dimming via pedal dimmer or via App for iOS and Android operating systems.

The base and the pedal dimmer are made of metal and available in matt white or chrome finish.

「タケ・プラス BTオーバル」は、楕円形のベースに垂直から12度傾斜した支柱に5つあるいは6つのモジュールで構成されたフロアタイプのランプ、LED光源をポリエチレン製グローブ内に中心から全体に向け配置、それにより各モジュールは色温度3000ケルビンの光を周囲に均等に広げることができます。出力は5モジュールで80ワット、6モジュールで96ワットの二種類があります。調光機能については、従来の照明本体から直接操作するものに加え、新たにスマートフォン（iOSおよび Android）等からAppを通じて調光可能な機能も搭載しました。照明ベースと調光装置ともなるアダプターは金属製で塗装は、ホワイ半光沢、クロムの二種類があります。



Finishes

- 106 Matt white
- 150 Chrome

Diffuser

PE Polyethylene opal white

Cable

Transparent

Electronic driver

Dimmable included

Dimmer

Pedal dimmer and Bluetooth control App for Android and iOS systems

Light source LED

LED 220/240V

TAKÉ PLUS BT OVAL 05 80W
5500lm 3000K CRI>90

TAKÉ PLUS BT OVAL 06 96W
6600lm 3000K CRI>90

A

Certification

CE EAC PS E F Classe I IP20

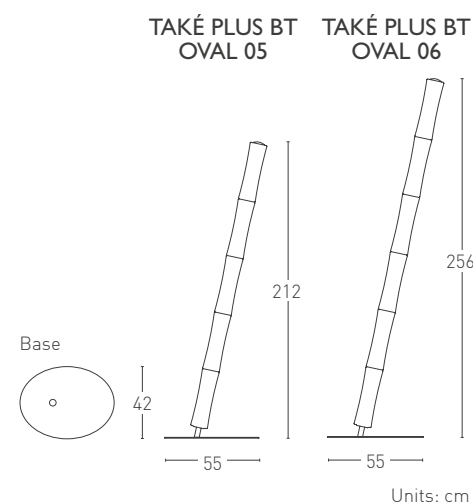

TAKÉ PLUS BT S&P 04/05/06

Design Villa Tosca

TAKÉ PLUS BT S&P è una particolare versione soffitto-pavimento che ottimizza lo spazio necessario al collocamento della lampada. Il punto di ancoraggio è a soffitto e viene alimentata tramite una normale presa elettrica a parete. È disponibile a 4, 5 o 6 moduli. È dotata di variatore di intensità luminosa e fornisce una luce uniforme lungo tutto l'elemento diffusore grazie alla particolare tecnologia LED utilizzata.

In dotazione standard nuovi driver con controllo della dimmerazione diretta tramite dimmer a pedale o tramite App per sistemi operativi iOS e Android.

Dimmer a pedale e parti metalliche sono disponibili in bianco opaco o cromato.

TAKÉ PLUS BT S&P is a unique ceiling-floor version that optimizes the available space to collocate the lamp. The anchoring point is on the ceiling and it is powered through a normal electric wall socket. It is available with 4, 5 or 6 sections. It is equipped with a dimmer and gives a uniform light along the whole diffuser thanks to its particular LED technology.

In standard equipment new drivers with direct control of dimming via pedal dimmer or via App for iOS and Android operating systems.

Pedal dimmer and metal parts are available in matt white or chrome.

「タケ・プラス BT S&P」は、特別なシーリング/フロアーランプのバージョンです。空間のニーズに適応した形でランプを配置することができます。アンカーポイントは、天井に取り付け、電源は通常の壁に取り付けられた電源プラグを利用することができます。4、5、6モジュールのバリエーションがあります。なお調光器を内蔵しており、特別なLEDテクノロジー採用により光を各モジュール全体に広げることが出来ます。調光機能については、従来の照明本体から直接操作するものに加え、新たにスマートフォン（i-OSおよび Android）等からAppを通じて調光可能な機能も搭載しました。照明ベースと調光装置ともなるアダプターは金属製で塗装は、ホワイト半光沢、クロムの二種類があります。

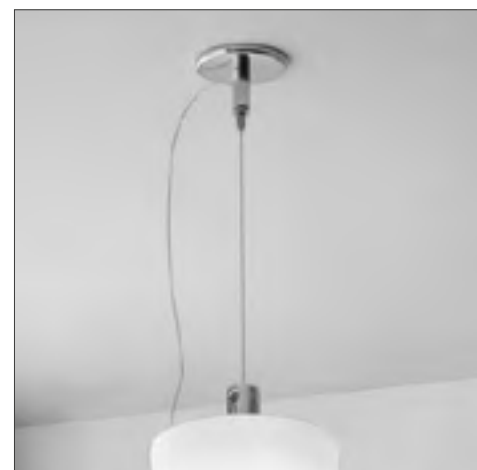
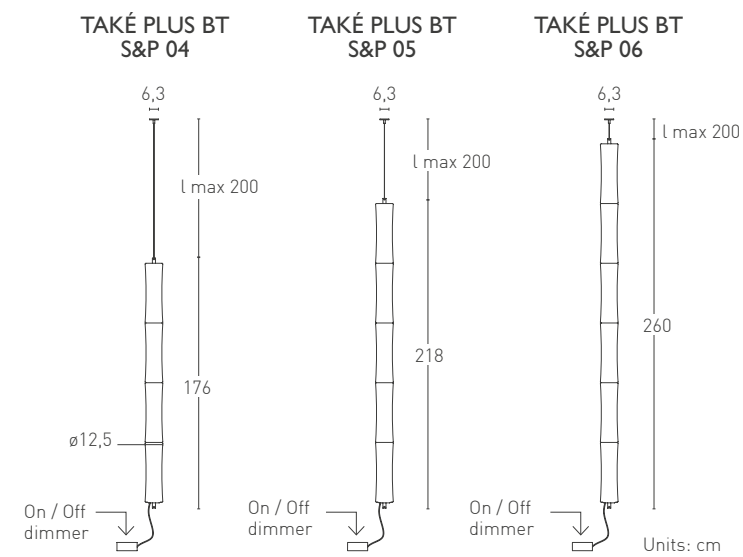

Finishes

- 106 Matt white
- 150 Chrome

Diffuser

PE Polyethylene opal white

Cable

Transparent

Electronic driver

Dimmable included

Dimmer

Pedal dimmer and Bluetooth control App for Android and iOS systems

Light source

LED

LED 220/240V

TAKÉ PLUS BT S&P 04 64W
4400lm 3000K CRI>90

TAKÉ PLUS BT S&P 05 80W
5500lm 3000K CRI>90

TAKÉ PLUS BT S&P 06 96W
6600lm 3000K CRI>90

A

Certification

CE EAC PS E F Classe I IP20



TAKÉ PLUS ON-OFF S1/S2/S3/S4/S5/S6

Design VillaTosca

TAKÉ PLUS ON/OFF si declina nelle versioni a sospensione da 1 fino a 6 elementi. Gli attacchi forniti consentono di realizzare versioni in orizzontale, verticale o obliquo. A seconda del numero di elementi, varia la potenza luminosa dei circuiti LED utilizzati: da 16W e 1100lm per l'elemento singolo a 96W e 6600lm per il sistema a 6 elementi. La temperatura di colore dei LED utilizzati è 3000K. Il diffusore è realizzato in PE bianco opale. La finitura delle parti metalliche è bianco opaco o cromato. Accensione ON-OFF, a richiesta dimmer integrato nell'alimentatore con controllo della funzione PUSH o tramite App per sistemi operativi iOS e Android.

TAKÉ PLUS ON/OFF extends its versions from 1 up to 6 sections suspension lamps. The supplied ceiling holders allow you to make a horizontal, vertical or oblique lamp mounting. According to the number of elements, the light power of the LED strips varies: from 16W and 1100 lm for the single section to 96W and 6600 lm for the 6 sections lighting fixture. The colour temperature of the LED is 3000K. The diffuser is made in opal white PE. The metal parts finish is matt white or chrome. ON-OFF switch and upon request integrated dimmer in the power supply with control of PUSH function or via App for iOS and Android operating systems.

「タケ・プラス-オン/オフ」は、1つから6つのモジュールで展開されるペンダントタイプのランプです。付属の取付金具によって、水平/垂直/傾斜の異なる設置が可能です。全体の出力はモジュールに内蔵されるLED光源の違いで変動します。シングルモジュールは16ワット1100ルーメン、6モジュールは96ワット6600ルーメン。色温度は3000ケルビンのLEDを使用。グローブはポリエチレン製のオパール・ホワイト仕上げ。金属部の塗装は、ホワイト半光沢、クロムの二種類があります。調光機能については長押しボタン式の調光に加え、新たにスマートフォン (i-OSおよびAndroid) 等からAppを通じて調光可能な機能を選択することもできます。

SET-UP MODALITIES

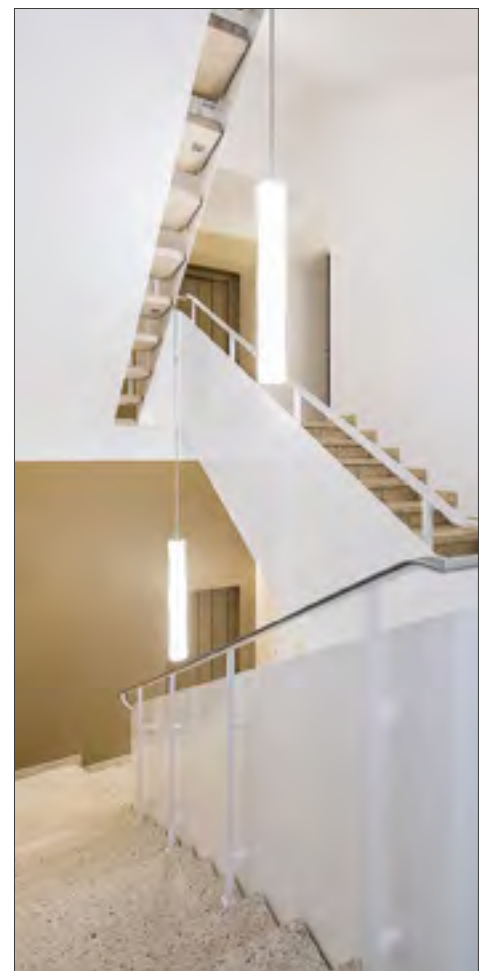
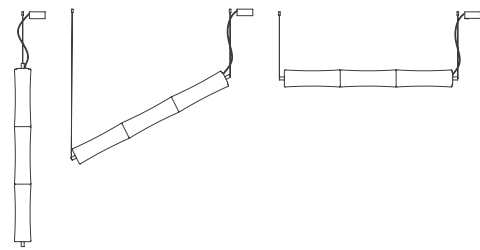

Finishes

- 106 Matt white
- 150 Chrome

Diffuser

PE Polyethylene opal white

Cable

Transparent

Electronic driver

Standard version ON / OFF
or
Dimmer included by request for BT version (Bluetooth) application for Android and iOS Systems

Light source

LED

LED 220/240V

TAKÉ PLUS ON/OFF S1 16W

1100lm 3000K CRI>90

TAKÉ PLUS ON/OFF S2 32W

2200lm 3000K CRI>90

TAKÉ PLUS ON/OFF S3 48W

3300lm 3000K CRI>90

TAKÉ PLUS ON/OFF S4 64W

4400lm 3000K CRI>90

TAKÉ PLUS ON/OFF S5 80W

5500lm 3000K CRI>90

TAKÉ PLUS ON/OFF 6 96W

6600lm 3000K CRI>90

A

Certification

CE EAC PS E F Classe I IP20

TAKÉ PLUS S1 TAKÉ PLUS S2 TAKÉ PLUS S3 TAKÉ PLUS S4 TAKÉ PLUS S5 TAKÉ PLUS S6

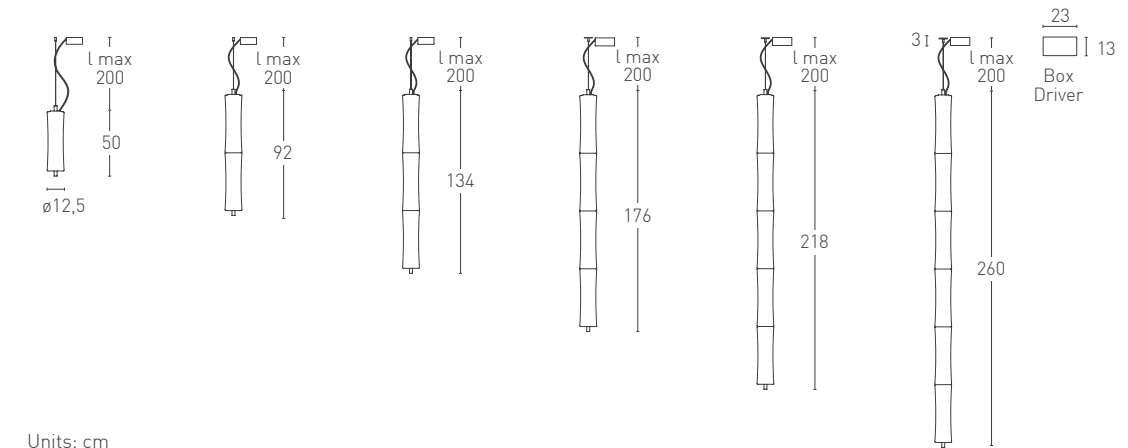

Units: cm



TAKÉ PLUS 21

Design VillaTosca

TAKÉ PLUS 21 è la versione applique della linea, si presta ad essere inserita come punto luce a parete in piccoli spazi, nicchie o corridoi. Il diffusore in PE bianco opale diffonde in maniera uniforme la luce generata dalla sorgente LED da 16W con resa luminosa di 1100lm. L'attacco ed i particolari in metallo sono disponibili nelle finiture cromato o bianco opaco.

TAKÉ PLUS 21 wall lamp version. Suitable for small spaces, niches or corridors. The white opal PE diffuser, gives uniform light thanks to its 16W LED light source, with a 1100lm light output. The wall plate and the metal parts are available in chrome or matt white finish.

「タケ プラス 21」は、シリーズの中のウォールタイプのランプです。ポイントランプとして小さな空間の壁や壁の奥まり、廊下などに適したランプです。グローブは、ポリエチレン樹脂オパール・ホワイトでLED光源は16ワット/1100ルーメンの光を一定に拡散します。

取り付けアーム及びメタル製の台座は、クロムとホワイト半光沢の二種類のカラーが用意されています。



Finishes

- 106 Matt white
- 150 Chrome

Diffuser

PE Polyethylene opal white

Electronic driver

Dimmable included PUSH, 1...10

Light source **LED**

LED 16W 220/240V
1100lm 3000K CRI>90

A

Certification

CE EAC F PS E IP20 Classe I

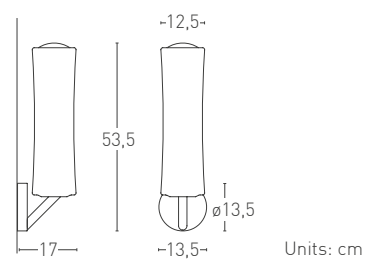

TAKÉ 27/27-I / BUBBLE 04/08

Design VillaTosca

TAKÉ 27 è un sistema di lampade a sospensione semplificato, che permette di utilizzare normali lampadine con attacco E27 fino ad un massimo di 57W. La versione da 1 modulo può essere fissata al soffitto tramite rosone oppure con attacco ad incasso (TAKÉ 27-I). Disponibile con dettagli metallici cromati o laccati bianco opaco.

Partendo dal singolo modulo TAKÉ 27 è possibile configurare sospensioni multiple utilizzando 4, 8 o 12 elementi. Ogni versione dispone di un rosone *ad hoc* con finitura cromo o bianco opaco.

TAKÉ 27 is a simplified system of suspension lamps which allows to use conventional bulbs with E27 sockets, max 57W. The 1 section version can be mounted to the ceiling by means of the ceiling rose or the built-in kit (TAKÉ 27-I). Available with chrome or matt white metal details.

Starting from the single section of TAKÉ 27 it is possible to create multiple suspensions made of 4, 8 or 12 sections. Each version is supplied with an ad hoc ceiling rose, available in chrome or matt white.

「タケ27」は、シンプルなペンダントタイプのランプシステム。E27の金口に最大57ワットの電球の使用が可能です。このシングルモジュールのバージョンは、フランジの取付金具または埋め込み式 (タケ27-I)の二種類があります。ディテール部品の塗装は、クロム、ホワイト半光沢があります。

「タケ27」のシングルモジュールをベースに4、8、12灯式のシャンデリアタイプの構成が可能です。各バージョンごとに特別なフランジが用意されています。塗装は、クロムとホワイト半光沢があります。



Finishes

- 106 Matt white
- 150 Chrome



Diffuser

PE Polyethylene opal white

Cable

Transparent

Suggested light source

-  E27 Halogen ECO
max 1/4/8x57W
-  E27 ECO Fluo
max 1/4/8x23W

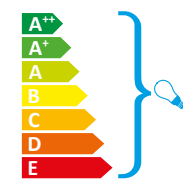

Certification

CE EAC PS E F Classe I IP20

TAKÉ 27

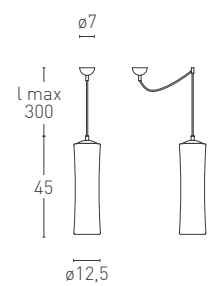

TAKÉ 27-I

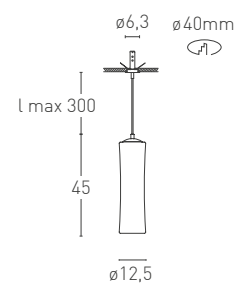

TAKÉ BUBBLE 04

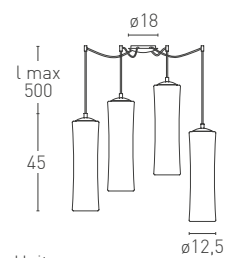

TAKÉ BUBBLE 08

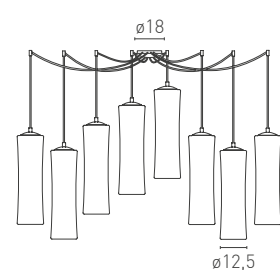

Units: cm

VIRGOLA

Design VillaTosca



STILE MINIMAL,
LUCE AL MASSIMO

VIRGOLA, applique caratterizzata dal design estremamente minimale: la lampada é infatti concepita per ottenere il miglior rendimento luminoso con il minore ingombro e utilizzo di materiale.

MINIMAL DESIGN,
MAXIMUM LIGHT PERFORMANCE.

VIRGOLA, wall lamp characterized by an extremely minimal design: the lamp is in fact designed to obtain the best illumination result in a minimum amount of space and with the smallest use of materials.

ミニマル・スタイル
最大の光

「ヴィルゴラ」は、ウォールタイプの間接照明ランプです。究極のミニマル・デザインを特徴とする製品で、最低限の大きさと最小限のマテリアルの消費によって最大の光効率を実現するべくデザインされました。

VIRGOLA

Design VillaTosca

VIRGOLA, lampada da parete a luce indiretta. Il design estremamente minimal che caratterizza il prodotto, consente la massima resa della tecnologia LED utilizzata. Disponibile con sorgente LED da 20W e 1560lm. Finiture fine textured (FT): bianco, grigio sabbia, emerald e oxyde.

VIRGOLA, indirect light wall lamp. The extremely minimal design that characterizes the product allows the maximum exploitation of the LED technology used. Available with LED light source 20W and 1560lm. Fine textured (FT) finishes: white, sand grey, emerald and oxyde.

「ヴィルゴラ」は、ウォールタイプの間接照明ランプです。究極のミニマル・デザインを特徴とする製品で、使われているLED光源技術が与えるその効果は製品のコンセプトに大きく貢献しています。LED光源は、20ワット/1560ルーメン。塗装は、ファイン・テクスチャー塗装 (FT) : ホワイト、サンド・グレイ、エメラルド、オレンジの4種類が用意されています。

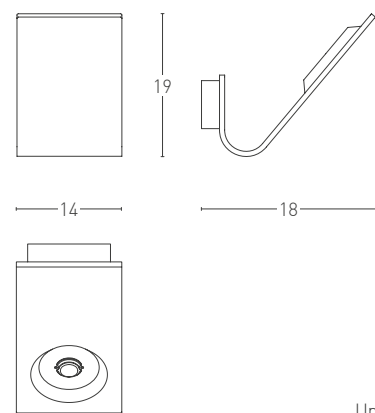

Finishes

- 105FT White
- 115R FT Sand grey
- 116FT Emerald
- 117FT Oxyde

Electronic driver

LED Light Engine dimmable TRIAC

Light source

LED

LED 20W 220/240V
1560lm 3000K CRI>90

A

Certification

CE EAC F Classe I IP20

Units: cm



555 LED / 570 LED

Design Elio Giudici, 1974/2016

555 e 570, storici pezzi della collezione LUMEN CENTER ITALIA, rispettivamente in versione da terra e applique. Il diffusore orientabile è realizzato in metallo, così come il resto della struttura. Forniscono luce indiretta. Disponibili nelle finiture: nero opaco, ottone satinato, cromo, ottone lucido e nichel satinato. Versione da terra dotata di regolatore di intensità luminosa.

555 and 570, historical pieces belonging to the LUMEN CENTER ITALIA collection, respectively floor and wall versions. The adjustable diffuser is made of metal, as the rest of the structure. The lamps give indirect light. Available in the following finishes: matt black, satin brass, chrome, polished brass and satin nickel. The floor version is supplied with a lighting dimmer.

「555」と「570」は、ルーメンセンターのコレクションの中でも歴史的な作品です。この製品は、フロアタイプとウォールタイプで構成されています。拡散光板をはじめ本体は全てメタル製です。ディフューザーの向きが調整が可能です。新たに搭載されたLEDによる間接照明をお届けします。カラーは、ブラック半光沢、真鍮サテン仕上げ、クロム仕上げ、真鍮磨き仕上げ、ニッケル・サテン仕上げが用意されています。フロアタイプには調光器が付属しています。

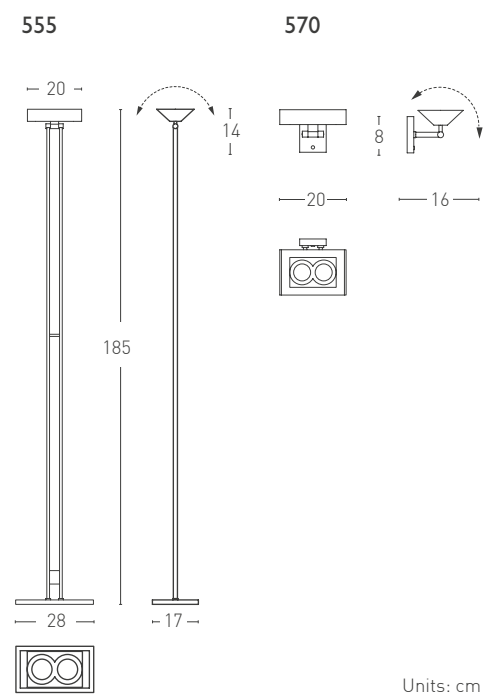

Finishes

- 102 Matt black
- 150 Chrome
- 152 Satin brass
- 153 Polished brass
- 166 Satin nickel

Electronic driver

570 LED Light Engine Dimmable TRIAC

Dimmer

555 Switch dimmer included

Light source

LED

LED 30W 220/240V
2310lm 3000K CRI>90

A

Certification

CE EAC F Classe I IP20



BLUM LED

Design Bernard Brousse, 1997/2016

Disegnata da Bernard Brousse nel 1997 per LUMEN CENTER ITALIA, BLUM è da allora icona della collezione Classic LCI. Realizzata in metallo e caratterizzata da linee molto semplici è disponibile nelle finiture: nero opaco, bianco opaco, grigio sabbia FT, oxyde FT.

Designed by Bernard Brousse in 1997 for LUMEN CENTER ITALIA, BLUM since then has been an icon of the Classic LCI collection. Made of metal and characterized by very simple lines, it is available in matt black, matt white, sand grey FT, oxyde FT.

1997年ベルナルド・ブルッスによってルーメンセンター・イタリアのためデザインされた作品です。「ブルム」はその当時よりLCIクラシックコレクションの代表的な作品です。メタル製のシンプルなラインによって描き出された作品で、塗装は、ブラック半光沢、ホワイト半光沢、FTサンド・グレー、FTオレンジの4種類が用意されています。



Finishes

- 102 Matt black
- 106 Matt white
- 115R FT Sand Grey
- 117 FT Oxyde

Electronic driver

LED Light Engine Dimmable TRIAC

Light source

LED

LED 15W 220/240V
1155lm 3000K CRI>90

A

Certification

CE EAC F IP20

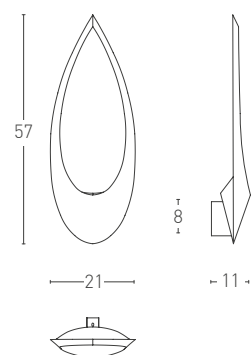

Units: cm



EAGLE LED

Design Gilles Derain, 1984/2015

Lampada da parete a luce indiretta, disegnata da Gilles Derain nel 1984 per LUMEN CENTER ITALIA. Realizzata in metallo laccato a polveri epossidiche. Sorgente LED.

Indirect light wall lamp, designed by Gilles Derain in 1984 for LUMEN CENTER ITALIA. Made of lacquered metal in epoxy powder. LED light source.

ウォールタイプ間接照明ランプ。1984年にジル・デレンによってルーメンセンター・イタリアのためにデザインされたランプ。筐体はスチール製でエポキシ樹脂塗装仕上げ。光源はLEDに換装。

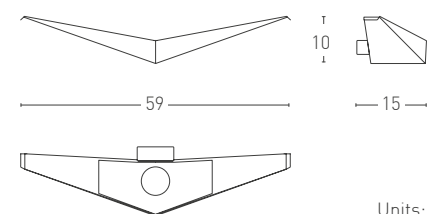

Finishes

- 102 Matt black
- 106 Matt white
- 115R FT Sand grey
- 117 FT Oxyde

Electronic driver

LED Light Engine dimmable TRIAC

Light source

LED

LED 20W 220/240V
1560lm 3000K CRI>90

A

Certification

CE EAC F Classe I IP20



HELIOLED

Design VillaTosca, 1996/2009

HELIOLED, lampada da tavolo a luce diffusa bianca e colorata. Utilizza 3 sorgenti LED RGB da 1W e 2 sorgenti LED bianche da 1W. Base in alluminio pressofuso laccato a polveri epossidiche. Finiture disponibili: nero lucido e bianco lucido. Diffusore in vetro di Murano bianco opale acidato.

HELIOLED, table lamp with white and coloured light. It uses 3 RGB LED light sources of 1W and 2 white LED of 1W each. Base in die-cast aluminium lacquered with epoxy powders. Available finishes: glossy black and glossy white. Diffusers in acid opal white Murano glass.

白色光と多彩なカラーを再現できるテーブルランプ。RGBで3x1ワットのLEDとホワイトLEDの2系統を使用。本体ベースはアルミダイキャスト成型で、エポキシ樹脂塗装が施されています。ブラック光沢とホワイト光沢の二種類の塗装を用意しています。グローブは、ホワイト・オパールのヴェネチア・ムラーノガラスを使用しています。

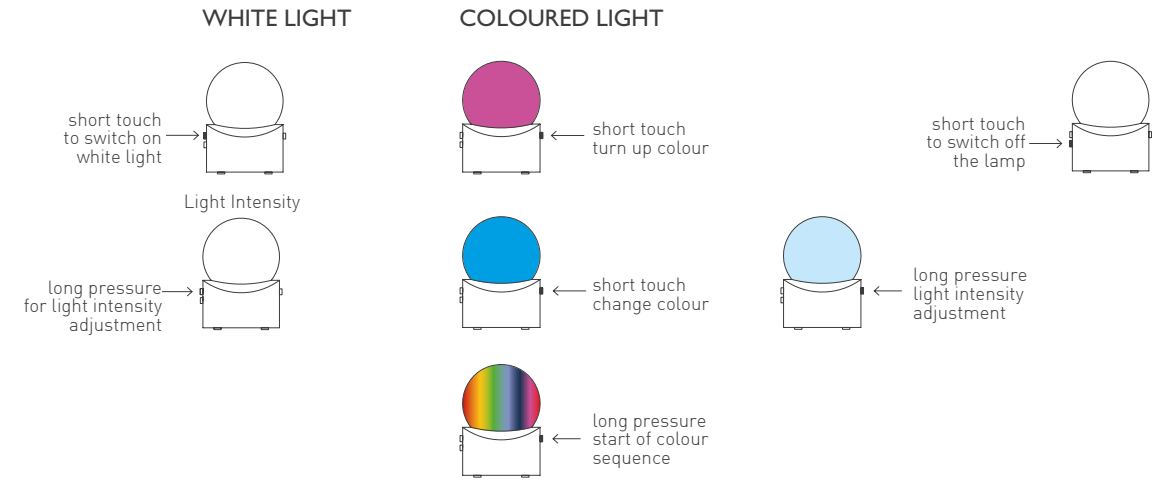
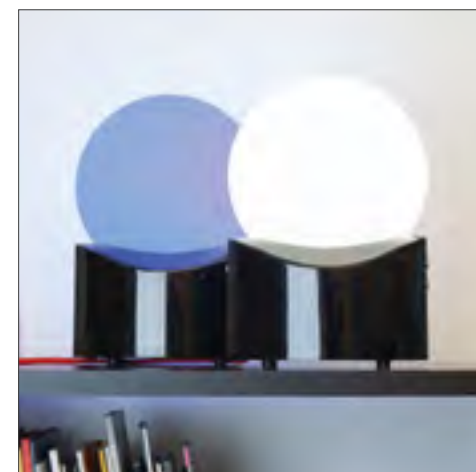
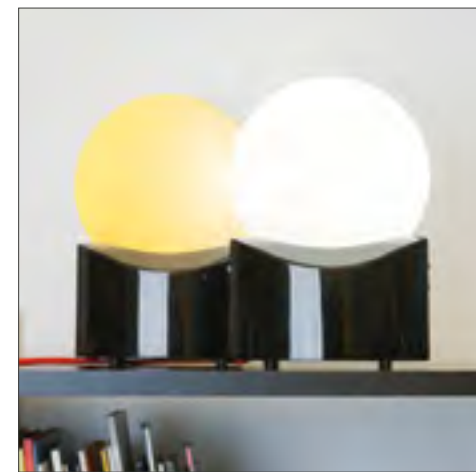
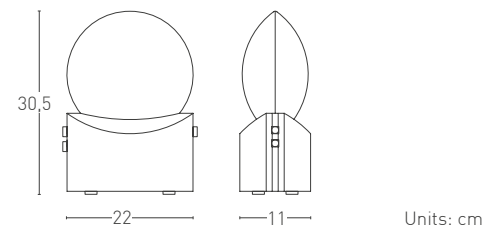

Finishes

- 112 Glossy black
- 114 Glossy white

Diffuser

03 Murano glass acid opal white

Cable

Red fabric

Electronic driver

Dimmable included

Light source LED

LED RGB 3x1W 220/240V
LED WHITE 2x1W 220/240V
4000K CRI>80



Certification

CE EAC F Classe I IP20

HELIOS

Design VillaTosca 2014

HELIOS, lampada da tavolo con sorgente LED **luum**® 12W 350mA 730lm 2700K CRI>97. Emette luce bianca diffusa di altissima qualità con spettro luminoso molto simile a quello della luce naturale. Regolatore di intensità luminosa incluso. Base in alluminio pressofuso verniciato, disponibile nelle finiture grigio perla e grigio grafite FT.

*HELIOS, table lamp with LED **luum**® sources 12W 350mA 730lm 2700K CRI>97. It recreates white high quality diffused light very similar to the natural light spectrum. Dimmer included. Base in die-cast varnished aluminum, available in pearl grey and graphite grey FT finishes.*

「ヘリオス」は**luum**®シリーズのLED(12ワット、350ミリアンペア、730ルーメン、2700ケルビン、CRI>97)を使用したテーブルランプです。太陽の光が持つ自然光のスペクトルに非常に近い高品質の白色光が特徴です。電源スイッチで調光が可能。本体ベースはアルミダイキャスト製で塗装仕上げ。色はパールグレーと梨地状のファインテクスチャー(FT)グレー。

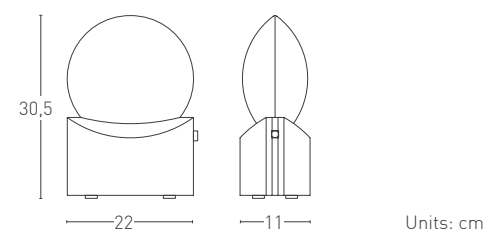
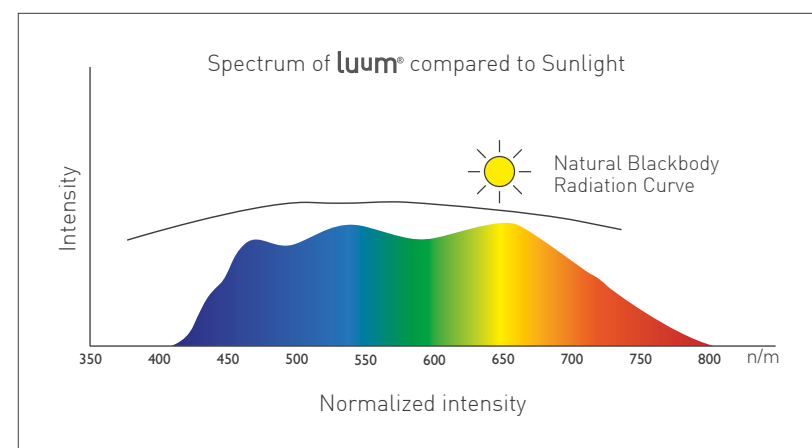
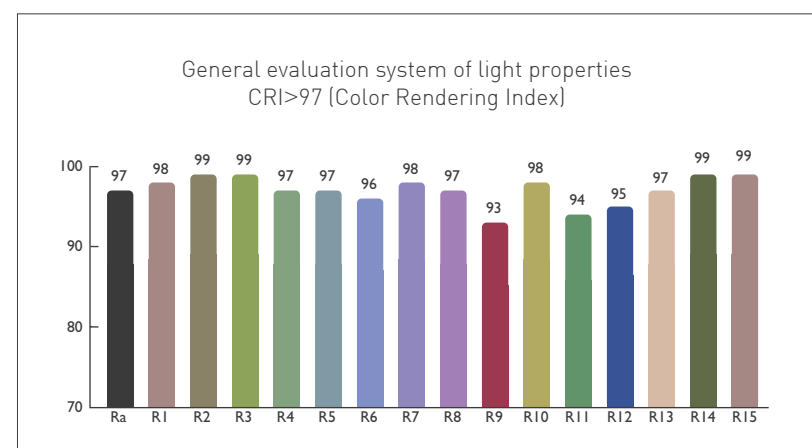

Finishes

- 115D FT Graphite grey
- 123 Pearl grey

Diffuser

03 Murano glass acid opal white

Cable

Black fabric

Electronic driver

Dimmable included

Light source

LED

LED 12W 350mA 220/240V **luum**®
730lm 2700K CRI>97

A

Certification

CE EAC F IP20



ICE / ICE II/21

Design Elio Giudici, 1989

ICE è la famiglia di lampade disegnata nel 1989 da Elio Giudici per LUMEN CENTER ITALIA. Le versioni tavolo, terra e applique si adeguano, da allora, al cambiare dei tempi risultando essere un vero e proprio "classico contemporaneo". Stelo in vetro Pyrex e anima in metallo cromato. Diffusore in cristallo trasparente acidato. Sorgente alogena dimmerabile per la versione da terra.

ICE is a family of lamps designed by Elio Giudici in 1989 for LUMEN CENTER ITALIA. Table, floor and wall lamp versions adapt themselves to the changing times being perfectly contemporary classics. Stem in Pyrex glass and core in chromed metal. Diffuser in acid transparent glass. Dimmable halogen source for the floor version.

「アイス」は1989年にエリオ・ジューディチによってルーメンセンター・イタリアのためにデザインされた照明シリーズです。バリエーションとして、テーブル、フロアー、ウォールを有して居り、そのデザインは時の流れを超越した言わば「現代に生まれた古典」を思わせるものです。筐体はバイレックスガラス（強化ガラス）とクロムメッキ仕上げの金属のコンビ、セードはつや消しのクリスタルガラス製。光源はハロゲン。フロアーランプは調光機能内蔵。

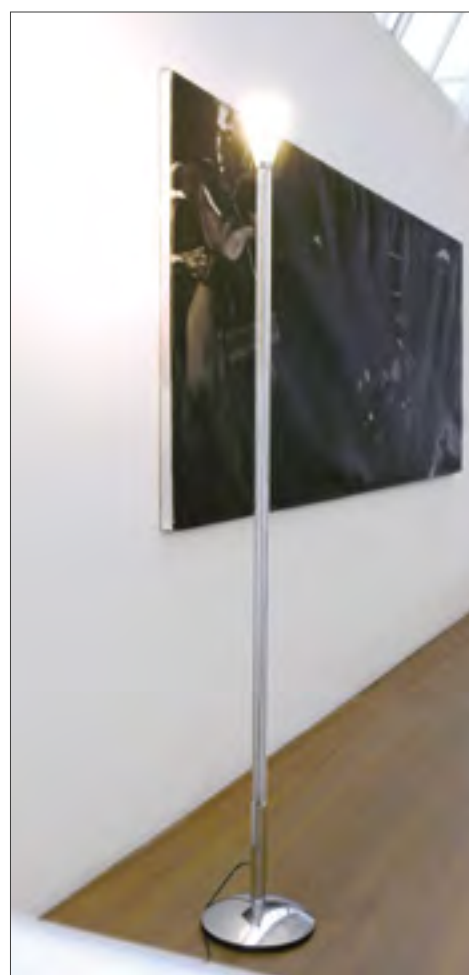
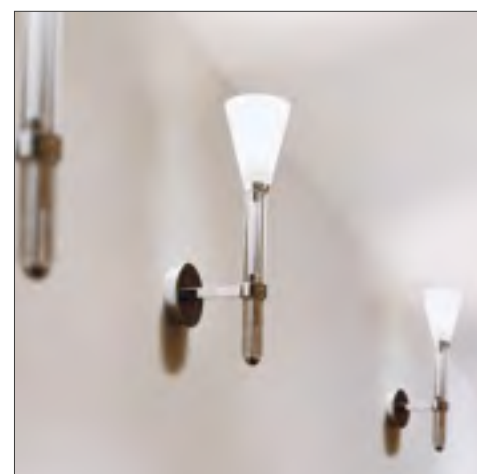
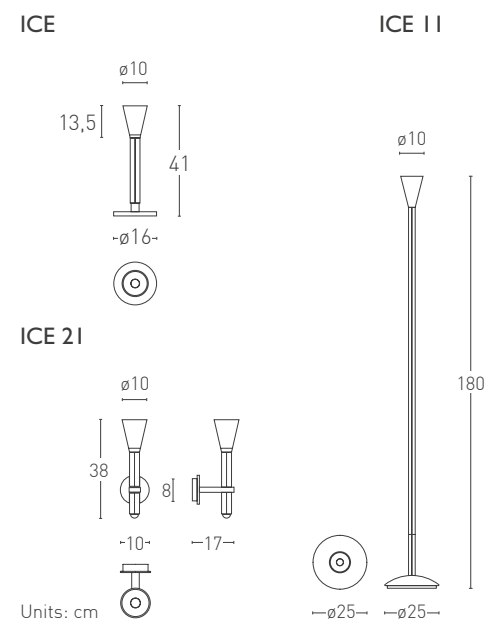

Finishes

● 150 Chrome

Diffuser

04 Acid transparent glass

Cable

ICE II Black

Dimmer

Included

Suggested light source

 B15d Halogen bayonet ECO
max 1x150W

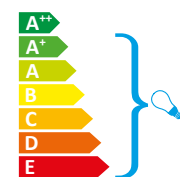

Certification

    IP20

ICE / ICE II 

ICE 21 Classe I



MCP LED

Design Gilles Derain, 1980/2016

Importante esemplare della collezione Classic LCI, la lampada da terra MCP (Merci Chateau Pierre) fu disegnata nel 1980 da Gilles Derain in onore del celebre architetto de "La Maison de Verre", Pierre Chateau. Realizzata in metallo laccato a polveri epossidiche, utilizza sorgenti a LED ed è dotata di regolatore di intensità luminosa. Disponibile nelle finiture nero opaco o alluminio sabbia- to con particolari cromati.

Important piece of LCI Classic collection, MCP (Merci Chateau Pierre) is a floor lamp designed by Gilles Derain in 1980 in honor of the famous architect Pierre Chateau de "La Maison de Verre". It is made of lacquered metal in epoxy powders. Light source LED and dimmer included. Available in matt black or sandblasted aluminum finishes with chromed details.

「MCP (Merci Chateau Pierre)」はLCIのクラシック・コレクションの中でも重要なフロアーランプです、これは1980年にジル・ドレーンが「ラ・メゾン・ド・ヴェール」の設計で有名な建築家ピエール・シャローに捧げる形でデザインしたものです。筐体はスチール製でエポキシ塗装仕上げ。光源には新たにLEDを搭載しました。調光機能内蔵。塗装はブラック半光沢及び梨地アルミカラーにクロムメッキのディテールによるコンビネーション。



Finishes

- 102 Matt black
- 121 Sandblasted aluminium

Details finishes

- 150 Chrome

Cable

Black

Dimmer

Switch dimmer included

Electronic driver

Dimmable included

Light source

LED

LED 40W 220/240V
3120lm 3000K CRI>90



Certification

CE EAC F Classe I IP20

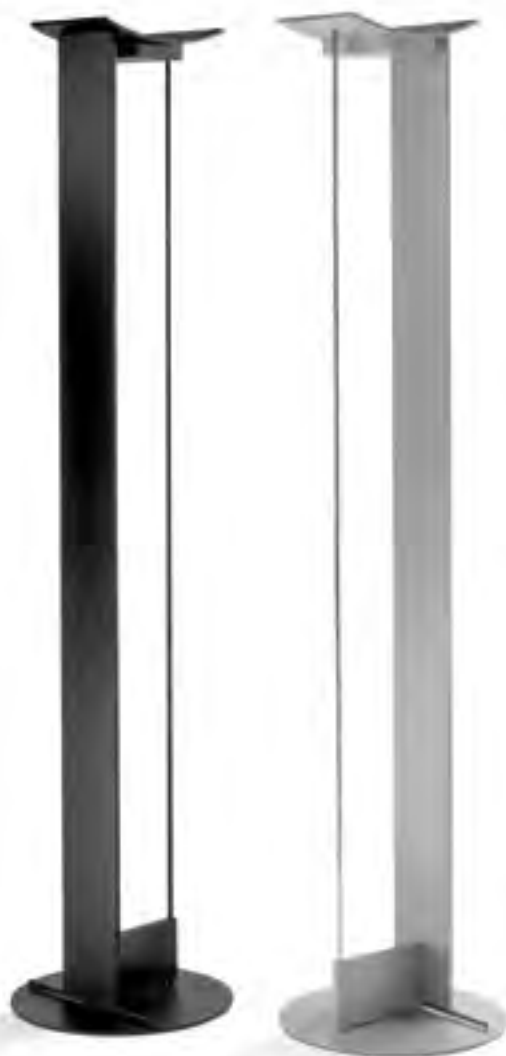
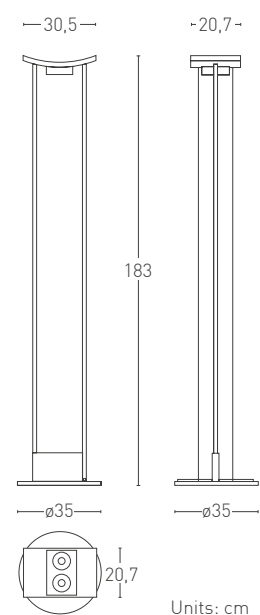

MEMORY STUDIO / NIGHT

Design VillaTosca 2005

MEMORY STUDIO e MEMORY NIGHT nascono come omaggio al designer francese Jacques Adnet e ne declinano il progetto - rieditato da LUMEN CENTER ITALIA e chiamato MJA - in una versione da tavolo più alta con snodi sia nello stelo che nella calotta, e nella versione applique. Attacco universale E14.

MEMORY STUDIO and MEMORY NIGHT were born as a tribute to the French designer Jacques Adnet and decline his project - reissued by LUMEN CENTER ITALIA and called MJA - in a wall and table version which is higher and which has junctions both in the stem and in the shell. They are supplied with universal E14 socket.

「メモリー・スตูーディオ」と「メモリー・ナイト」は、フランス人デザイナー:ジャック・アドゥネに敬意を表して生まれた作品。ルーメンセンターによって「MJA (エムジェイエー)」として再版された作品のバリエーションです。ウォールタイプのバージョンは E14の金口が取り付けられています。

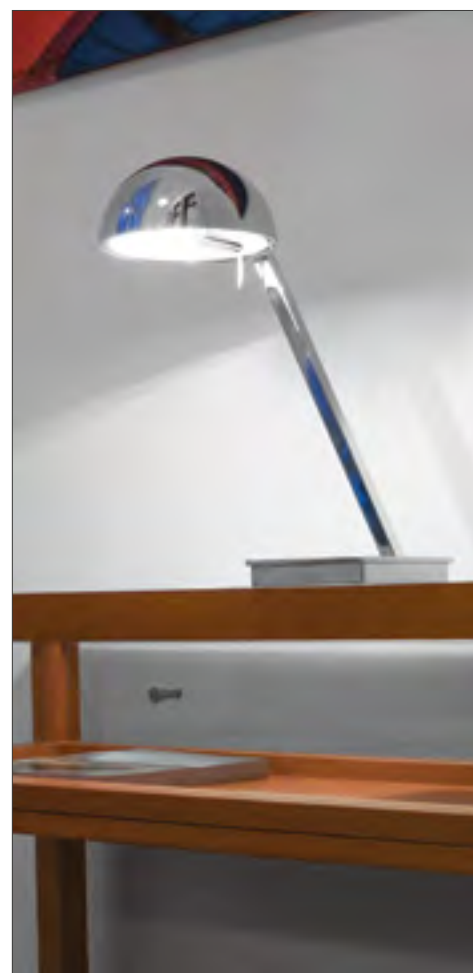
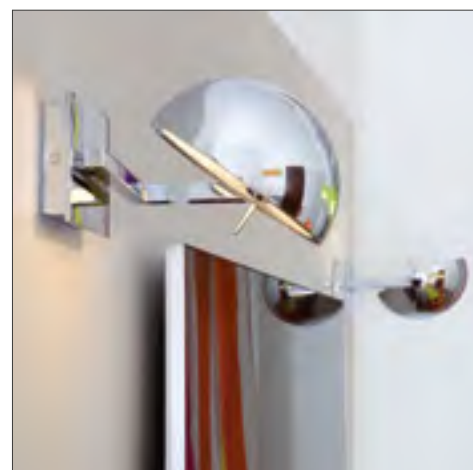

MEMORY STUDIO

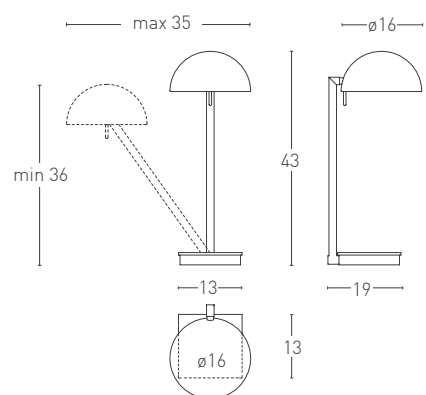

MEMORY NIGHT

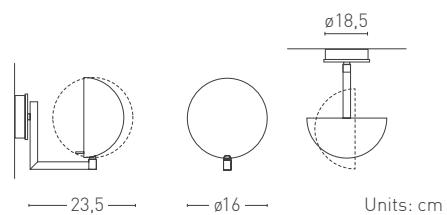

Finishes

- 150 Chrome

Cable

MEMORY STUDIO Transparent

Suggested light source

- E14 Halogen ECO max 1x30W
- LED E14

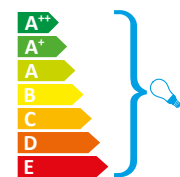

Certification

CE EAC IP20

MEMORY STUDIO

MEMORY NIGHT Classe I

MJA

Design Jacques Adnet, 1930

Lampada da tavolo disegnata nel 1930 da Jacques Adnet esponente di spicco del Modernismo francese e, in quegli anni, direttore de "La Compagnie des Arts Francais" in cui operarono Francois Jourdain, Charlotte Perriand e Georges Jouve. MJA (Memory of Jacques Adnet) entrò in produzione solo nel 2005; in precedenza non fu mai realizzata se non a livello di prototipo. La lampada, composta da una calotta sferica poggiata su un piedistallo dalla forma quadrangolare, è realizzata in ottone con finitura Palladio. Attacco universale E14.

Table lamp designed in 1930 by Jacques Adnet great exponent of French Modernism. During those years he was director of "La Compagnie des Arts Francais" where Francois Jourdain, Charlotte Perriand and Georges Jouve served too. MJA (Memory of Jacques Adnet) in production from 2005, was earlier only realized as a prototype. The lamp, with a spherical cap resting upon a quadrangular base, is made of brass with a Palladium finish. Socket E14.

1930年にフランスのモダニズムの第一人であるジャック・アドゥネによってデザインされたテーブルランプです。当時彼は「La Compagnie des Artes Francais」（芸術性の高い家具メーカー）のディレクターとして、シャルロット・ペリアン、フランシス・ジョルダン、ジョルジュ・ジューヴら錚々たるメンバーを指揮していました。MJA (Memory of Jacques Adnet (ジャック・アドゥネの記憶))は試作のみで生産は実現しなかった幻の作品を2005年に蘇らせたものです。四角形の台座の上に半球のセードを合わせた構成のランプで、真鍮製、パラディウムメッキ仕上げ。電球金口はE14。

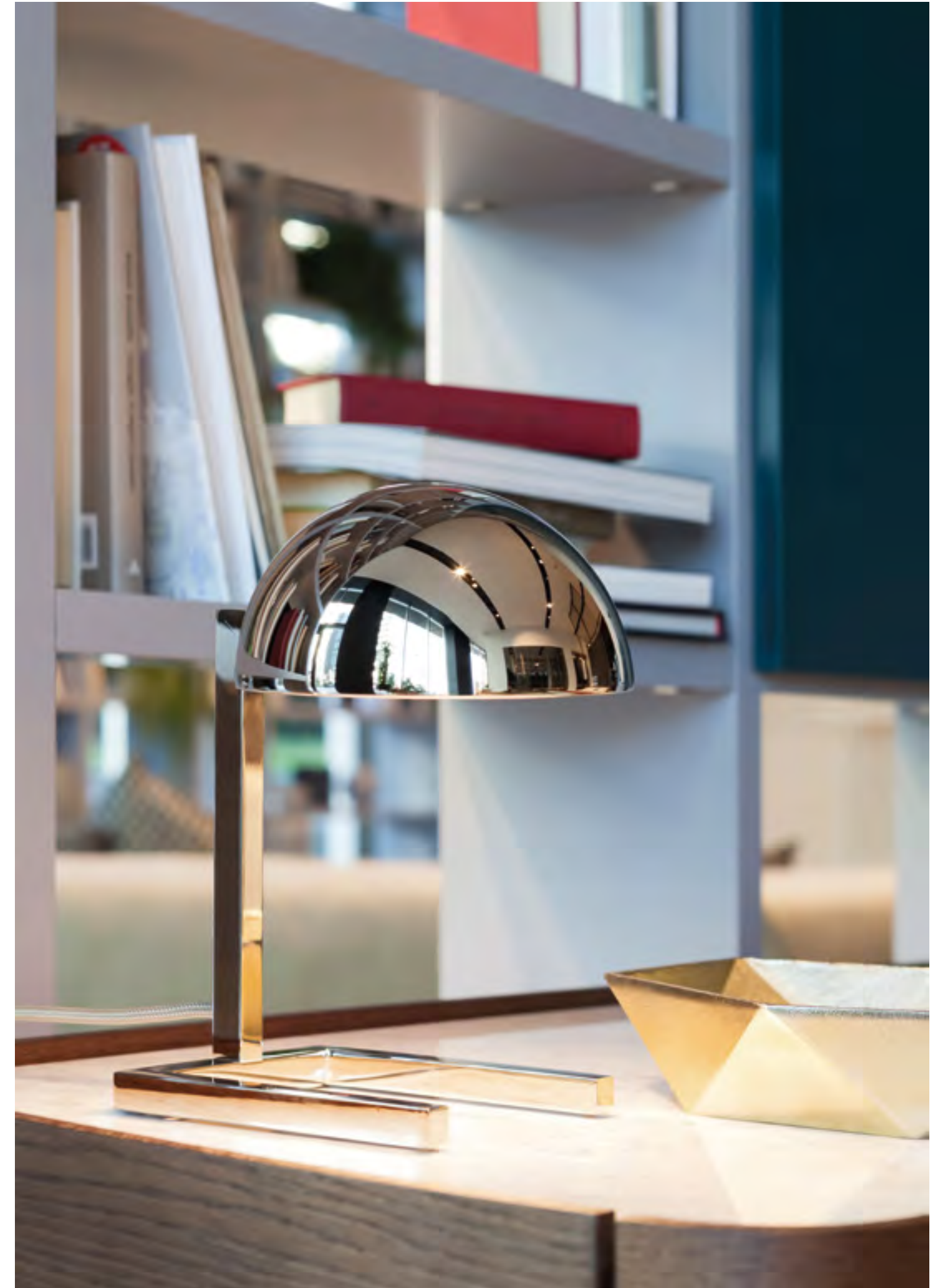

Finishes

160 Palladium

Cable

Transparent

Suggested light source

E14 Halogen ECO

max 1x30W

LED E14

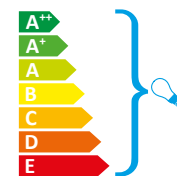

Certification

CE EAC PS E F IP20

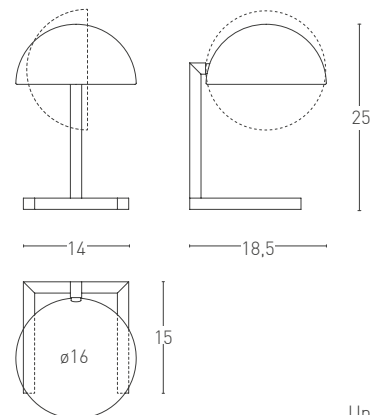

Units: cm

OMEGA LED

Design Gill Derain, 1984/2016

OMEGA intesa come conclusione perfetta di un lavoro iniziato con la prima lettera l'Alfa. La lampada OMEGA è un semicerchio in metallo che richiama l'incontro tra il cielo e la terra. Semplice nell'uso è un'icona dei Classici LCI e viene riproposta con sorgenti LED di nuova generazione per festeggiare il 40mo anniversario di fondazione dell'azienda. Diffonde una luce di altissima qualità (LED **luum**® CRI>97) con spettro luminoso molto simile a quello della luce naturale.

OMEGA understood as a perfect end to a job started with the first letter "Alfa". The OMEGA lamp is a metal semi-circle that recalls the encounter between heaven and earth. Easy to use, it is an icon of the Classics and LCI is producing the LED version to celebrate the 40th anniversary of the founding of the company.

*It uses **luum**® LED light source (CRI>97) with a very high quality light and with a bright spectrum similar to natural light.*

「オメガ」はα(アルファ)の文字から始まった仕事の最後を締めくくるに相応しい照明です。このテーブルランプは金属製の半球の形を持ち、それは天と地の出合いを連想させます。ルーメンセンターが生まれてから40周年を記念して、このクラシックLCIのアイコン的とも言えるこの照明をLED照明として復活させました。光源には自然光にとても近い高品質の光をお届けできるLED (LED **luum**® CRI>97) を使用しております。



Finishes

- 102 Matt black
- 106 Matt white

Cable

Black / Transparent

Electronic driver

Included

Electronic driver

Dimmable included

Light source

LED

LED luum® 12W 350mA
220/240V 730lm 2700K CRI>97

A

Certification

CE EAC F IP20

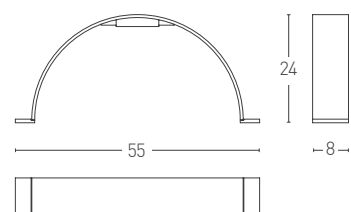
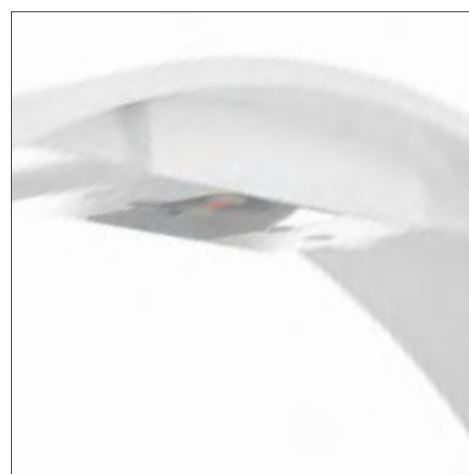

Units: cm

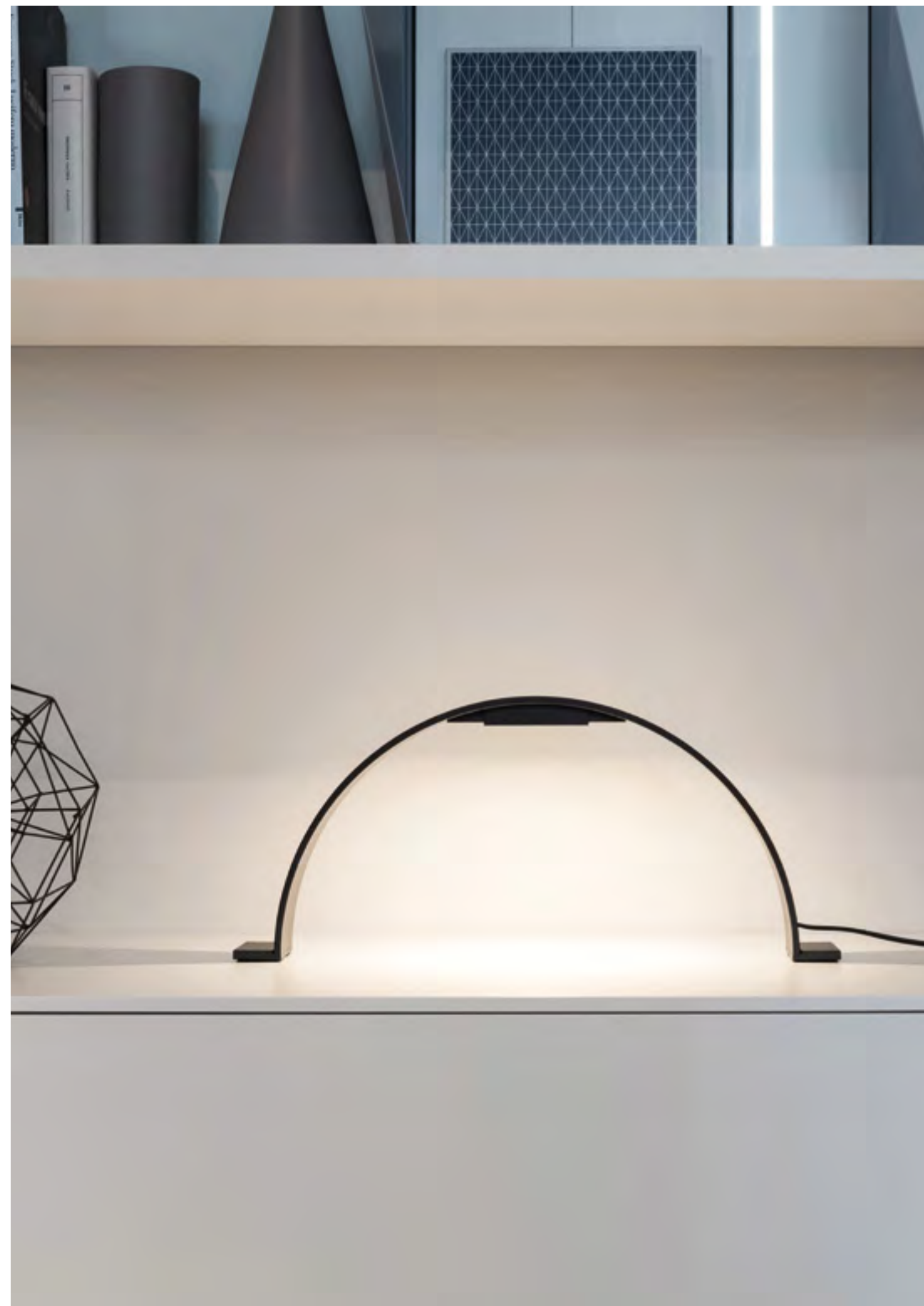

QUADRO LED VII (RE-EDITION 2014)

Design Jacques Adnet, 1929/2014

Lampada da tavolo icona della collezione Classic LCI disegnata nel 1929 da Jacques Adnet esponente di spicco del Modernismo francese e, in quegli anni, direttore de "La Compagnie des Arts Francais" in cui operarono Francois Jourdain, Charlotte Perriand e Georges Jouve. QUADRO, da sempre a catalogo LCI, fu realizzata su decisione dell'allora direttore artistico Gilles Derain, tra i primi estimatori e studiosi dei movimenti modernisti francesi. La lampada è realizzata in tubolare d'ottone con placcatura elettrolitica in Palladio. Diffusori in resina acrilica sabbata. Base in marmo nero marquina e cavo elettrico in tessuto nero. Pulsante di accensione con regolatore di intensità luminosa. Sorgenti luminose LED integrate.

Table lamp, icon of the Classic Collection LCI, designed in 1929 by Jacques Adnet great exponent of French Modernism and director of the "La Compagnie des Arts Francais" where Francois Jourdain, Charlotte Perriand and Georges Jouve also served. QUADRO, since ever in LCI catalogue, was built upon a decision by Gilles Derain, LCI artistic director and one of the French modernist movements estimators. The lamp is made with a tube shaped structure in brass with electrolytic plating in Palladium. Diffusers in sand acrylic resin. Base in black marquina marble and electric cable in black fabric. Dimmable power-button. Embedded LED light sources.

1929年にフランスのモダニズムの第一人者であるジャック・アドゥネによってデザインされたLCIのクラシック・コレクションを代表するテーブルランプです。当時彼は 'La Compagnie des Artes Francais' (芸術性の高い家具メーカー) のディレクターとして、シャルロット・ペリアン、フランシス・ジョルダン、ジョルジュ・ジューヴら錚々たるメンバーを指揮していました。「クアドロ」は常にLCIのカタログの中に位置していますが、始まりはフランスモダニズム運動の研究者としても第一人者でもあったアートディレクター、ジル・デレンの判断による復刻でした。ランプの筐体は管状の真鍮をパラディウムメッキで仕上げたもので、発光部はつや消し仕上げのアクリル製。台座は大理石(黒マルキナ石)、電源コードは布カバー仕様。電源ボタンは調光機能を兼ねています。光源はLED。

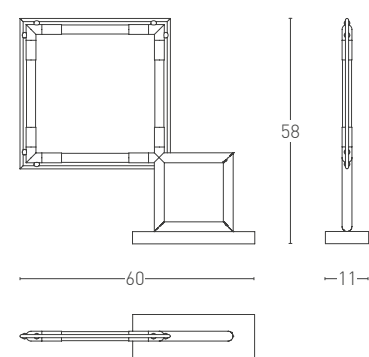

Units: cm



Finishes

● 160 Palladium

Diffuser

RA acrylic resin

Cable

Black fabric

Base

Black marquina marble

Electronic driver

Dimmable included

Light source

LED

LED 110/240V 8x2W
2000lm 2700K CRI>90

A

Certification

CE EAC PS E F IP20



MISTRAL LED 24/30/40/50 / RDS LED

Design Elio Giudici e Ivo Pellegrini, 1999/2014 / LCI Design 2003/2014

Sistema di illuminazione a plafone, realizzato con braccetti metallici. Utilizza sorgenti LED bispina. MISTRAL LED è disponibile nelle versioni a 24, 30, 40 e 50 luci. RDS LED è realizzato con 39 braccetti metallici disposti a 360° rispetto al rosone. Disponibili nelle finiture: cromo, ottone lucido e nichel satinato.

Ceiling lamp lighting system, made of metal arms, using LED light source. MISTRAL LED it is available with 24, 30, 40 and 50 lights. RDS LED made of 39 metal arms at 360° from the ceiling rose. Finishes available: chrome, satin nickel and polished brass.

「ミストラルLED」はメタル製のアームで構成されたシーリングタイプの照明システム。G4のLED光源を使用し、24灯、30灯、40灯、50灯式のバリエーションから選択可能です。
「RDS LED」はフランジから39本のアームが360度広がった構成を持つシーリングタイプの姉妹品です。共に仕上げは、クロム、ニッケル・サテン、ブラス磨き仕上げの三種類。



MISTRAL LED 24

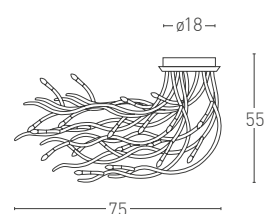

MISTRAL LED 40

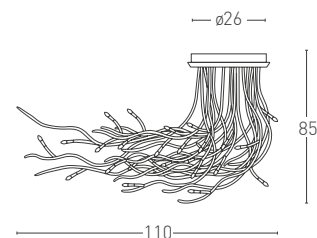

MISTRAL LED 30

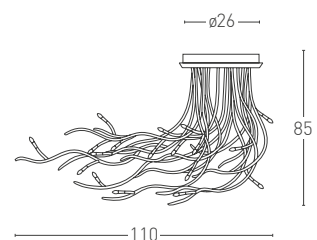

MISTRAL LED 50

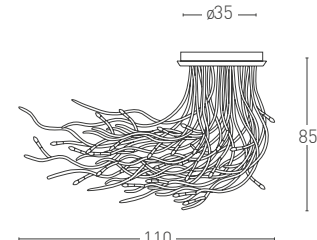

RDS LED

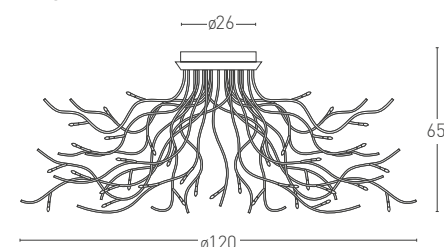

Units: cm

Finishes

- 150 Chrome
- 153 Polished brass
- 166 Satin nickel

Electronic driver

Included

Light source

LED

G4 Miniature Bulb Warm White 12V 220/240V
 MISTRAL LED 24 max 24x1W 2640lm
 MISTRAL LED 30 max 30x1W 3300lm
 MISTRAL LED 40 max 40x1W 4400lm
 MISTRAL LED 50 max 50x1W 5500lm
 RDS LED max 39x1W 4290lm

Certification

CE EAC PS E F Classe I IP20



SAUCER LED / SAUCER LED A

Design Gilles Derain, 1984/2015

SAUCER, lampada da parete disegnata da Gilles Derain nel 1984. Dotata di regolatore di intensità luminosa, è disponibile anche nella versione con attacco a terra.

SAUCER, wall lamp designed by Gilles Derain in 1984. Dimmer included. Also available with floor socket.

「ソーサー」はジル・デレンによって1984年にデザインされたウォールタイプのランプ。調光器付きで、壁付き電源プラグ仕様も用意しています。

Finishes

- 102 Matt black
- 150 Chrome
- 152 Satin brass
- 153 Polished brass
- 166 Satin nickel

Cable

SAUCER LED

Black

Electronic driver

SAUCER LED A

LED Light Engine Dimmable TRIAC

Dimmer

SAUCER LED Switch dimmer included

Light source

LED

LED 20W 220/240V

1560lm 3000K CRI>90

A

Certification

CE EAC F Classe I IP20

SAUCER LED

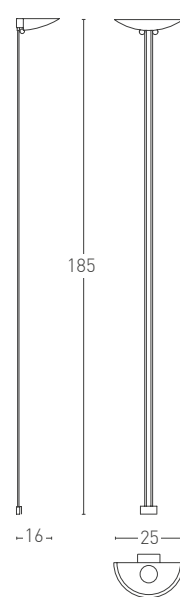

SAUCER LED A

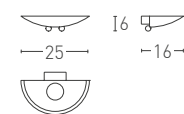

Units: cm

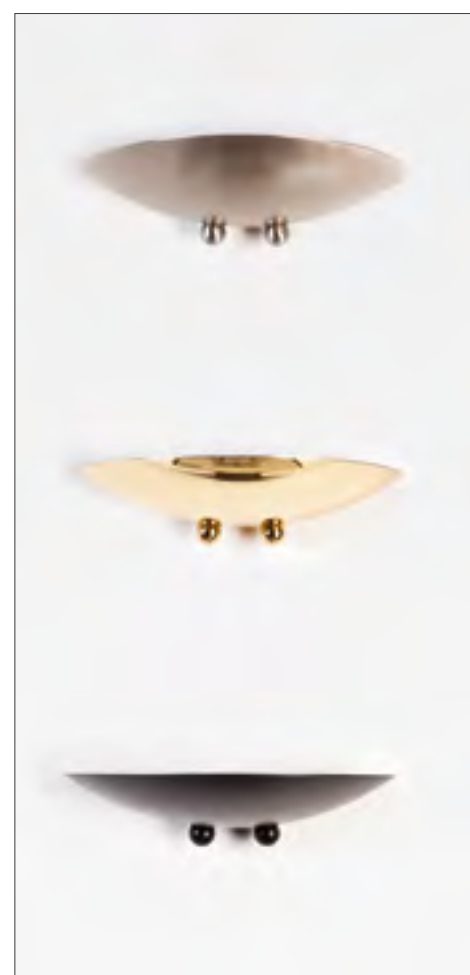
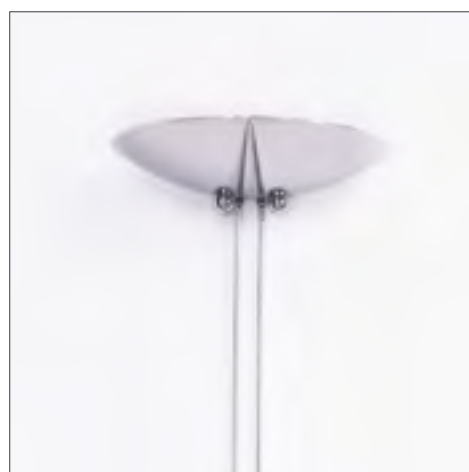

SHIP LED 30° RE-EDITION 2015

Design Gilles Derain, 1985/2015

Riedizione del progetto del 1985 di Gilles Derain, della piccola applique a forma di prua. Sorgente LED 3000K CRI>90. Disponibile nelle finiture nero opaco, bianco opaco, grigio sabbia FT e oxyde FT.

Re-edition of the small bow-shaped wall lamp designed by Gilles Derain in 1985. LED source 3000K CRI>90. Finishes: matt black, matt white, sand grey FT and oxyde FT.

1985年にジル・デレンによってデザインされた船先の様な形をした小型のウォールランプをリニューアル。光源は3000ケルビン、CRI>90のLED。カラーはホワイト半光沢、ブラック半光沢、または梨地状のファインテクスチャー(FT)グレーとFTオレンジ。



Finishes

- 102 Matt black
- 106 Matt white
- 115R FT Sand grey
- 117 FT Oxyde

Electronic driver

LED Light Engine dimmable TRIAC

Light source

LED

LED 20W 220/240V
1560lm 3000K CRI>90



Certification

CE ENEC F Classe I IP20

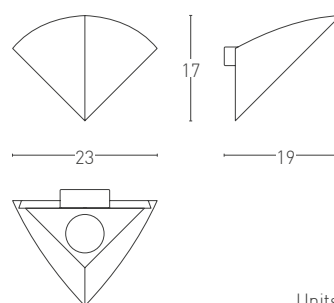

Units: cm



TORCHÉRE LED

Design Gilles Derain, 1984/2016

TORCHÉRE, in versione a LED, lampada da parete con attacco a terra. Struttura realizzata in metallo disponibile nelle finiture: acciaio inox lucido e satinato, laccato nero opaco e grigio sabbia FT. Regolatore di intensità luminosa incluso.

TORCHÉRE LED version, wall lamp with floor socket. Metal structure. Available finishes: polished and satin inox, lacquered matt black and sand grey FT. Dimmer included.

「トルシエ」は、壁付き電源プラグから給電するウォールタイプのランプです。形はそのままに光源はLEDに換装いたしました。メタル構造でステンレス磨き仕上げ、ステンレス・サテン仕上げ、ブラック半光沢塗装、アルミ・サンドブラスト仕上げが用意されています。調光器付き。

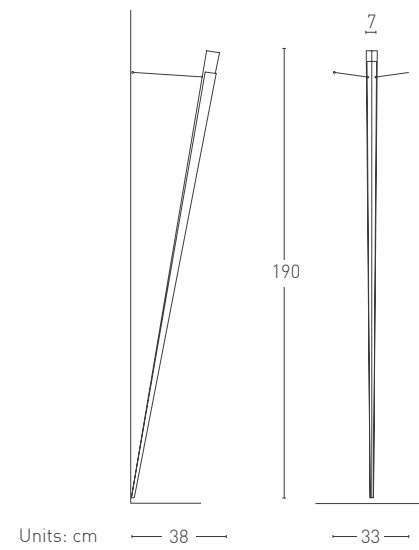

Finishes

- 102 Matt black
- 115R FT Sand grey
- 155 Polished inox
- 165 Satin inox

Cable

Black

Electronic driver

Dimmable included

Dimmer

Switch dimmer included

Light source

LED

LED 28W 220/240V
2845lm 3000K CRI>90

A

Certification

CE EAC  Classe I IP20

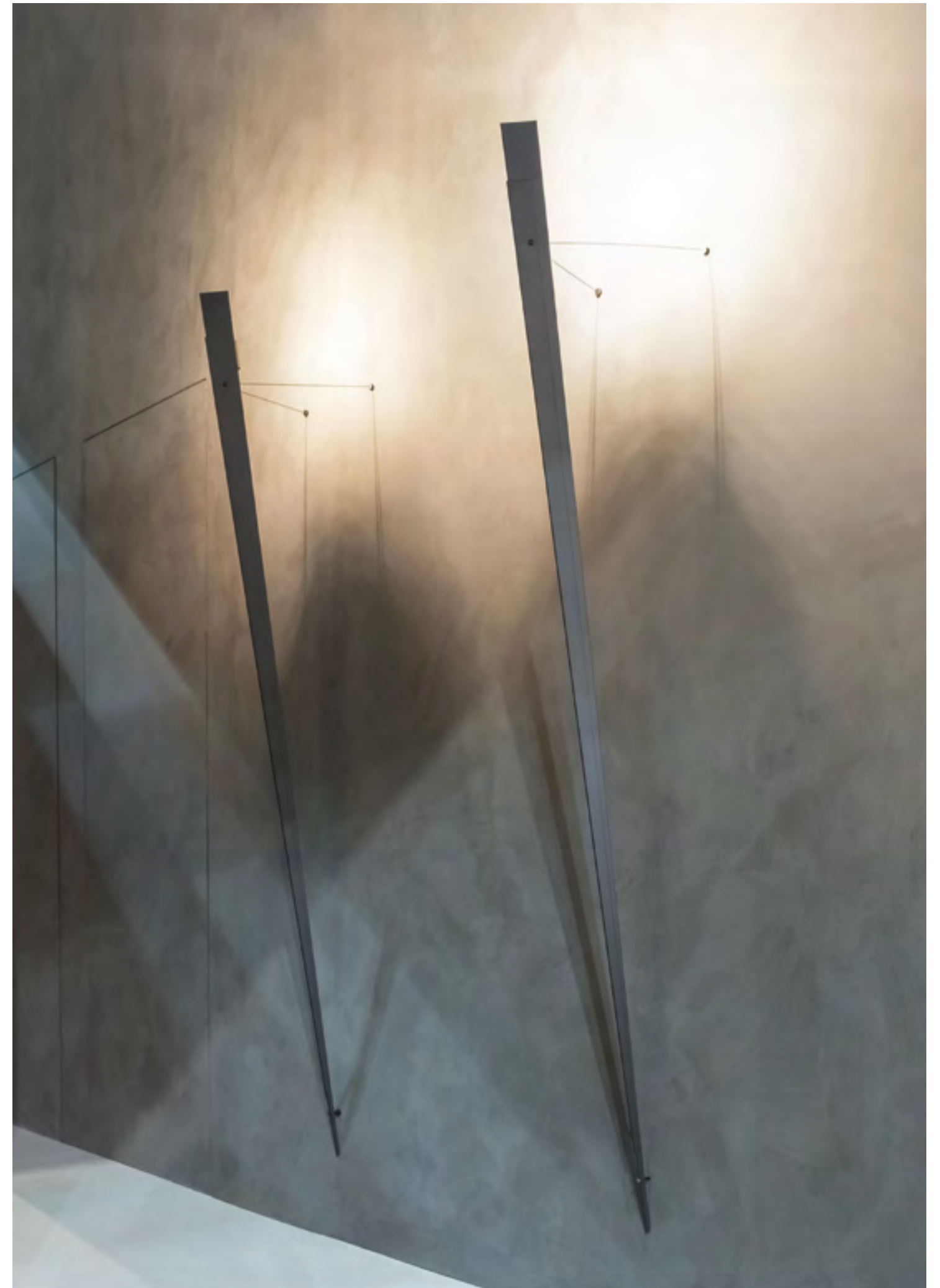

TRYLON LED / GRANDTRYLON

Design Gilles Derain, 1987

I classici TRYLON, ora in versione a LED, e GRANDTRYLON, rispettivamente lampade da parete e sospensione disegnate da Gilles Derain per LUMEN CENTER ITALIA. Realizzate in metallo, sono disponibili nelle finiture: nero opaco, grigio sabbia FT e cromo. La finitura inox satinato è disponibile solo per TRYLON.

The classics TRYLON, now in LED version, and GRANDTRYLON, respectively wall and suspension lamps designed by Gilles Derain for LUMEN CENTER ITALIA. Made of lacquered metal, they are available in the following finishes: matt black, sand grey FT and chrome. Satin inox finish available for TRYLON only.

ルーメンセンター・イタリアのためにジル・デレンがデザインした、ウォールタイプ、ペンダントタイプのクラシックコレクション「トリロン」,「グラランド・トリロン」、中でも「トリロン」はLED版へ進化しました。筐体はメタル製で塗装はブラック半光沢、FTサンド・グレーが用意されています。「トリロン」のみステンレス・サテン仕上げもお選びいただけます。

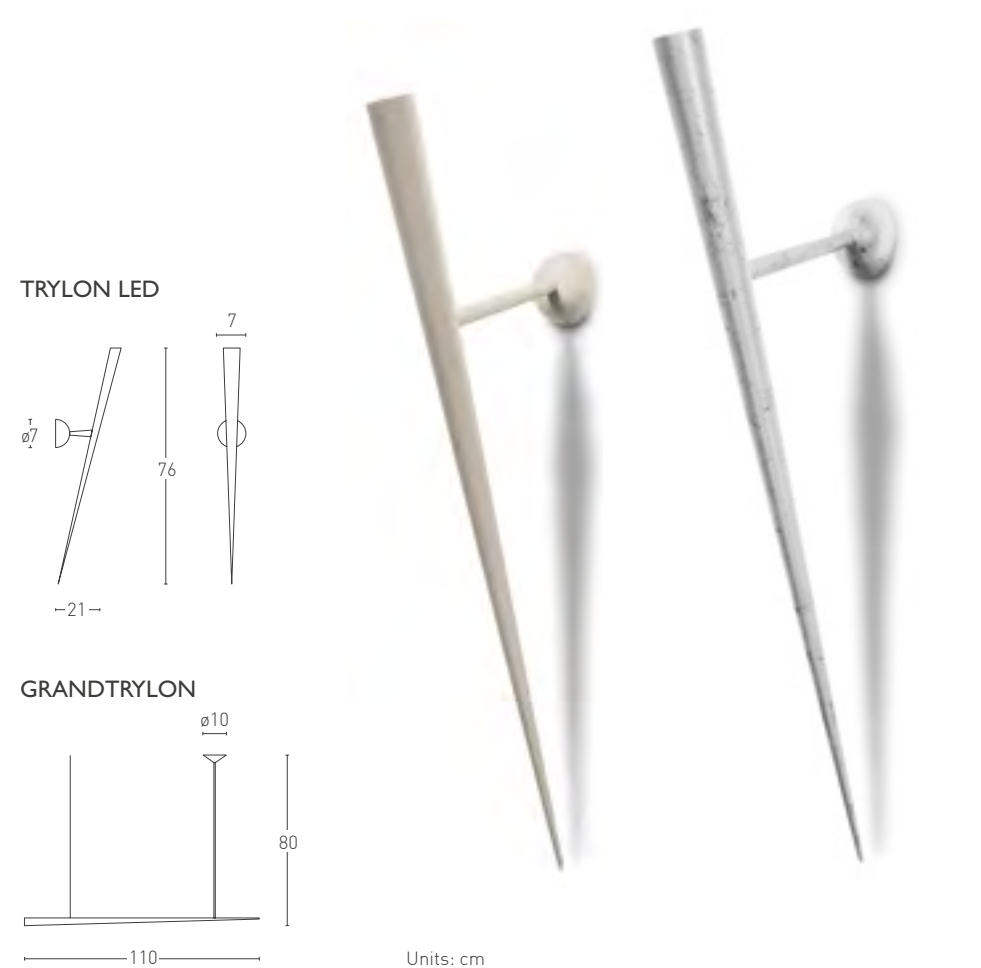

Finishes

TRYLON LED

- 102 Matt black
- 115R FT Sand grey
- 150 Chrome
- 165 Satin inox

GRANDTRYLON

- 102 Matt black
- 115R FT Sand Grey
- 150 Chrome

Electronic driver

LED Light Engine Dimmable TRIAC

Light source LED

TRYLON LED

LED 8W 220/240V
540lm 2700K CRI>90
A

Suggested light source

GRANDTRYLON

R7s Linear Halogen ECO 114,2 mm
max 1x230W

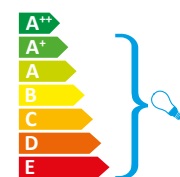

Certification

CE EAC F IP20

TRYLON Classe I

GRANDTRYLON

GRAF

Design Gilles Derain, 1991

Lampada da terra con attacco a parete disegnata da Gilles Derain nel 1991. Realizzata in metallo laccato a polveri epossidiche, è disponibile nelle finiture nero opaco, grigio sabbia FT e cromo. Regolatore di intensità luminosa incluso.

Floor lamp with wall fitting designed by Gilles Derain in 1991. Made of lacquered metal in epoxy powders, it is available in matt black, sand grey FT and chrome finishes. Dimmer included.

1991年にジル・デレンによってデザインされた壁に取り付けるタイプのフロアーランプ。筐体はスチール製でエポキシ樹脂塗装仕上げ。塗装の種類はブラック半光沢、梨地状のファインテクスチャー(FT)グレー、クロムメッキ。調光機能内蔵。

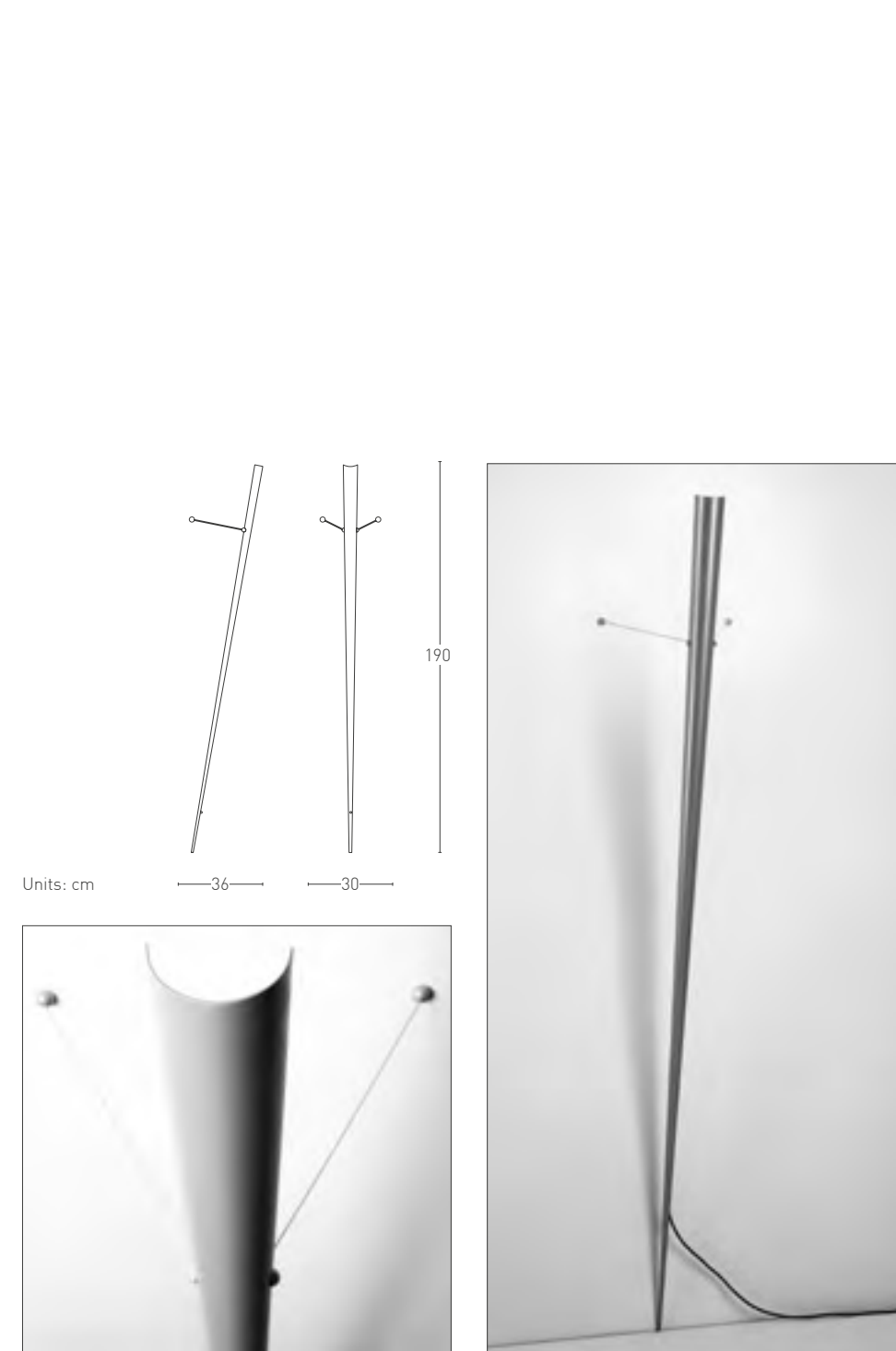

Finishes

- 102 Matt black
- 115R FT Sand grey
- 150 Chrome

Cable

Black

Dimmer

Included

Suggested light source

E27 Halogen ECO
max 1x205W

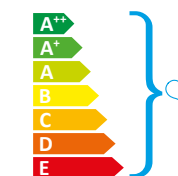

Certification

CE EAC F Classe I IP20

TUCA

Design Bernard Brousse, 1997

Lampada a sospensione dal design estremamente lineare progettata da Bernard Brousse nel 1997. Finiture disponibili: nero opaco, grigio perla, cromo.

Suspension lamp featured by an extremely linear design by Bernard Brousse, 1997. Available finishes: matt black, pearl grey, chrome.

1997年にバーナード・ブルースによってデザインされた極めて直線的なペンダントランプです。カラーはブラック半光沢、パールグレー、クロムメッキ。

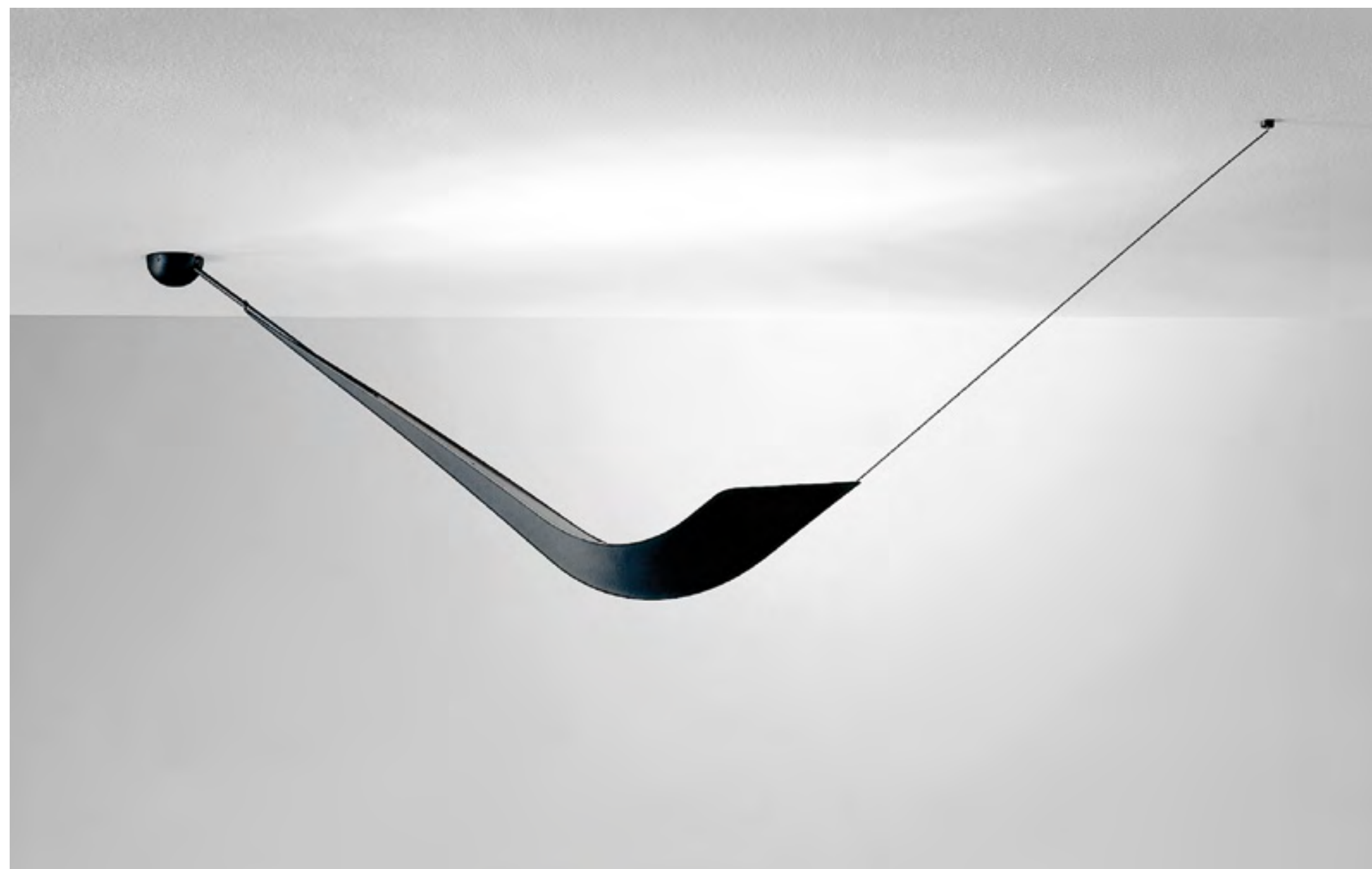

Finishes

- 102 Matt black
- 123 Pearl grey
- 150 Chrome

Suggested light source

➤ R7s Linear Halogen ECO 114,2 mm
max 1x230W



Certification

CE EAC F Classe I IP20

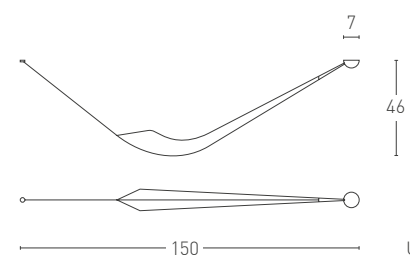

Units: cm

VICTORY LED

Design Artoff, 1984/2016

Lampada da terra, design Artoff del 1984. Il simbolo "V" come segno di vittoria. La grafica essenziale e l'armoniosa parabola orientabile, evocano il ricordo di un antico trofeo. Dotata di regolatore di intensità luminosa è disponibile nelle finiture: nero opaco, alluminio sabbiato, ottone lucido e cromo.

Floor lamp, designed by Artoff in 1984. The symbol "V" as a sign of victory. The essential graphics and harmonious adjustable reflector recall the memory of an ancient trophy. Dimmer included, it is available in the following finishes: matt black, sandblasted aluminium, polished brass and chrome.

勝利のシンボル"V"『ヴィクトリー』は古代のトロフィーを連想させる非常に簡潔なグラフィックを持ったフロアタイプのランプでアートオフによって1984年にデザインされた作品です。発光部でもある上部の半球体は角度が自由に変えられます。調光器付き。塗装は、ブラック半光沢、アルミ・サンドブラスト仕上げ、真鍮・磨き仕上げ、クロム仕上げ。

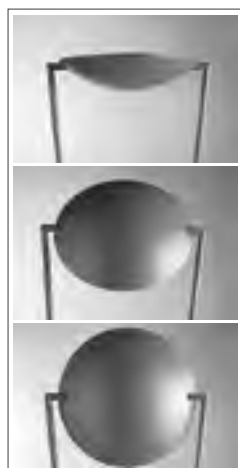

Finishes

- 102 Matt black
- 121 Sandblasted aluminium
- 150 Chrome
- 153 Polished brass

Cable

Black

Electronic driver

Dimmable included

Dimmer

Switch dimmer included

Light source

LED

LED 30W 220/240V
2310lm 3000K CRI>90

A

Certification

CE EAC  Classe I IP20

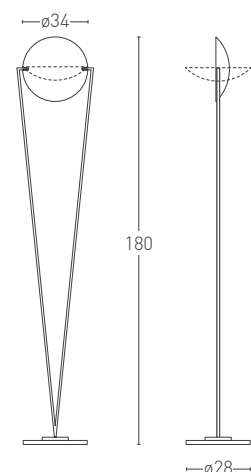

Units: cm



WASHINGTON LED

Design Jean-Michel Wilmotte, 1983/2015

Disegnata nel 1983 dall'architetto francese Jean-Michel Wilmotte per l'Ambasciata Francese di Washington DC, da sempre celebra l'eleganza istituzionale della Collezione Classic LUMEN CENTER ITALIA. Realizzata in metallo cromato o laccato con polveri epossidiche.

Diffonde una luce di altissima qualità (LED **luum**® CRI>97) con spettro luminoso molto simile a quello della luce naturale. Regolatore di intensità luminosa incluso.

Designed in 1983 by the French architect Jean-Michel Wilmotte for the French Embassy in Washington DC. It keeps on celebrating the institutional elegance of the Classic Collection of LUMEN CENTER ITALIA. Made in chromed metal or lacquered metal with epoxy powders.

*It uses **luum**® LED light source (CRI>97) with a very high quality light and with a bright spectrum similar to natural light. Dimmer included.*

1983年にワシントンDCのフランス大使館のためにフランスの建築家ジャン=ミッシェル・ウィルモットによってデザインされたLCIのクラシックコレクションの中でも特にエレガンスを感じさせるデスクランプです。

筐体はスチール製で、カラーはクロムメッキとエポキシ樹脂塗装仕上げのブラック。

光源には自然光に近いスペクトラムを持つ非常に高品質のLED(**luum**® CRI>97)を採用しています。

調光機能内蔵。

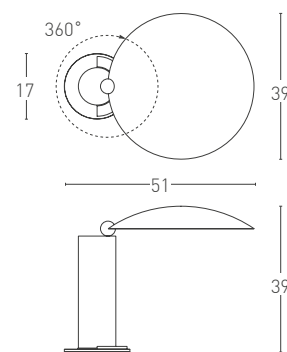

Units: cm

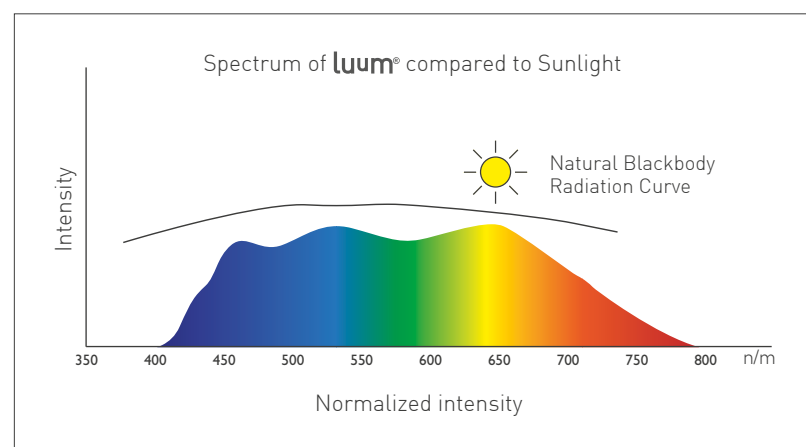
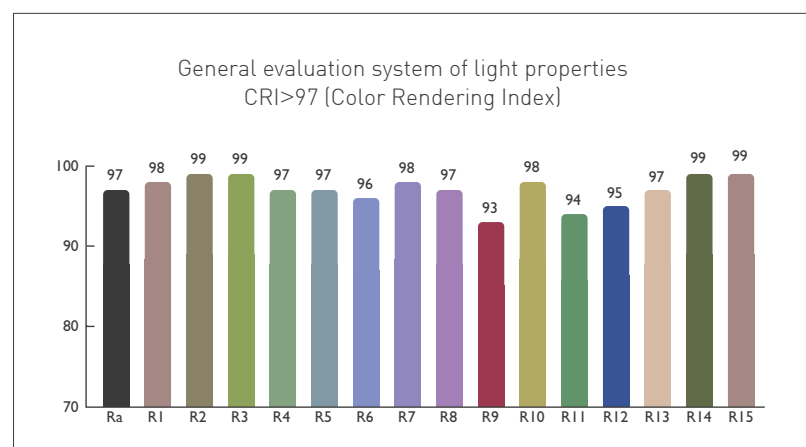

Finishes

- 102 Matt black
- 150 Chrome

Cable

Black fabric

Electronic driver

Included

Light source

LED

LED luum 12W 350mA 220/240V
730lm 2700K CRI>97

A

Certification

CE EAC F IP20



ISASS OPEN AIR

Design Mario Mazzer



NATURALI FORME LUMINOSE

ISASS è la rappresentazione luminosa di un cumulo verticale di sassi, TAKE il bambù. La naturalità delle sue forme la rende l'oggetto ideale per l'illuminazione di giardini e spazi all'aperto.

NATURAL LIGHTING SHAPES

Designed by Mario Mazzer, it's a luminous representation of a vertical rocks pile. Its natural forms are perfect for outside spaces and garden lighting.

自然な光の形

マリオ・マツエールによってデザインされた光る積み石を表現したランプシリーズです。その自然界に溶け込む姿は屋外や庭園の照明に非常に適しています。

ISASS OPEN AIR 03/10/11

Design Mario Mazzer

ISASS OPEN AIR, sistema di illuminazione per esterni con sistema di ancoraggio al terreno personalizzabile. La lampada può essere appoggiata al terreno con l'accessorio "base" o collocata nel terreno tramite l'accessorio "picket". È disponibile in tre diverse altezze ed è dotata di attacco universale E27.

ISASS OPEN AIR, outdoor lighting system with possibility of customized ground anchoring. The lamp can be placed on the ground by means of the "base" or with the "picket" accessory. It is available in three different heights and is supplied with an universal E27 bulb socket.

「イサッス・オープンエア」は屋外向けの照明システムで、設置する場所にあわせた様々な固定システムを有しています。基本はランプを付属の固定台座で設置しますが、アクセサリーの「ピケット（地杭）」で直接地面に差し込む事もできます。支柱の高さは3種類から選ぶことができます。電球金具はE27。

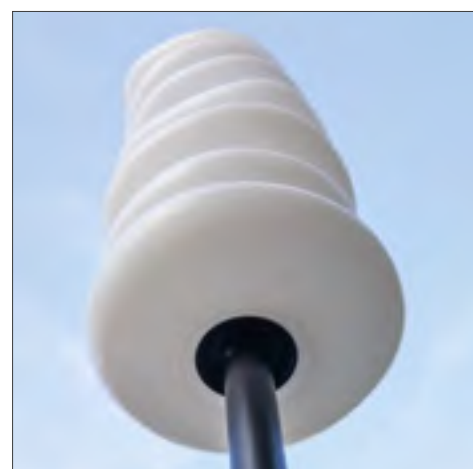

Finishes

- 173 Dark brown (outdoor use)

Diffuser

PE Polyethylene opal white

Cable

5/10 m on demand

Suggested light source

E27 ECO Fluo Warm Comfort Light
max 1x23W

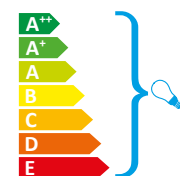

Certification

CE EAC F Classe I IP54

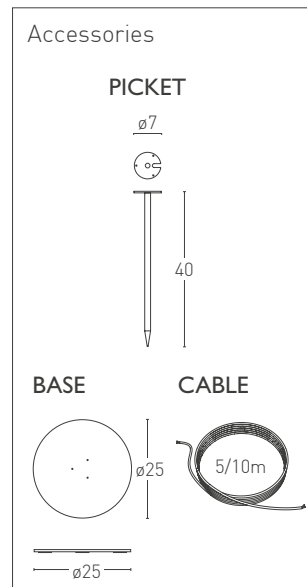
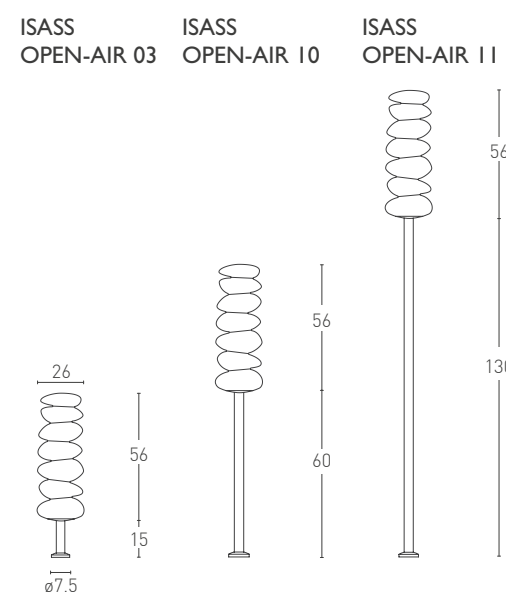

Units: cm



TAKÉ OPEN AIR

Design VillaTosca

OUTDOOR COLLECTION

Grazie agli accessori di cui è composta la serie, la lampada si presta ad essere utilizzata in vari contesti; con ancoraggio a terra o tramite picchetto diventa il prodotto ideale per costruire sistemi di illuminazione da giardino/terrazzo personalizzati.

OUTDOOR COLLECTION

Thanks to the various accessories available, this lamp is suitable for use in various contexts; by anchoring on the ground or through a picket, it becomes the ideal product to create customized garden/terrace lighting systems.

アウトドア・コレクション

設置する場所にあわせた様々なアクセサリを用意しています。基本はランプを付属の固定台座で設置しますが、アクセサリの「ピケット（地杭）」で直接地面に差し込む事もでき、庭やテラスの照明システムを構築するのに理想的なランプです。

TAKÉ OPEN AIR 03/10/11

Design VillaTosca

TAKÉ OPEN AIR è il sistema di illuminazione per esterni con sistema di ancoraggio al terreno personalizzabile. La lampada può essere appoggiata al terreno con l'accessorio "base" o collocata nel terreno tramite l'accessorio "picket". È disponibile in tre diverse altezze ed è dotata di attacco universale E27.

TAKÉ OPEN AIR is an outdoor lighting system with possibility of customized ground anchoring. The lamp can be placed on the ground by means of the "base" or with the "picket" accessory. It is available in three different heights and is supplied with an universal E27 bulb socket.

「タケ・オープンエア」は屋外向け照明システムです。用途に応じたアタッチメントの取り付け可能なアンカーシステムを持っています。このランプは、地上に固定する支柱によって固定、もしくは「ピケット（地杭）」によって直接地面に差し込んで固定することができます。3段階の高さのバージョンをそろえています。ランプの金口はE27を使用。

TAKÉ OPEN AIR 03 TAKÉ OPEN AIR 10 TAKÉ OPEN AIR 11

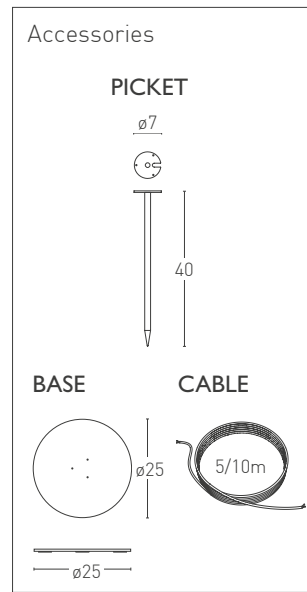
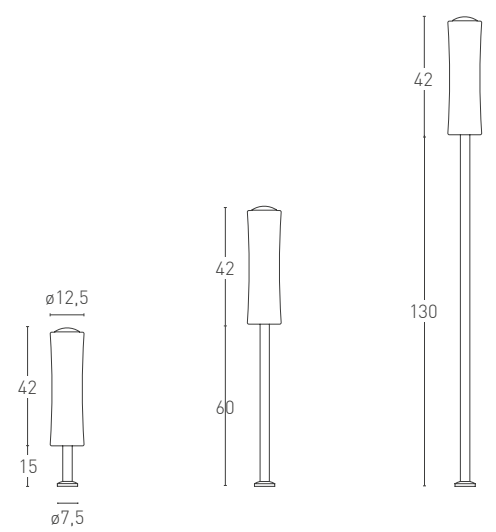

Units: cm



Finishes

- 173 Dark brown (outdoor use)

Diffuser

PE Polyethylene opal white

Cable

5/10 m on demand

Suggested light source

E27 ECO Fluo Warm Comfort Light
max 1x23W

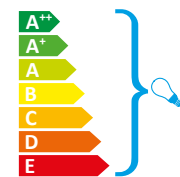

Certification

CE EAC F Classe I IP54



TAKÉ OPEN AIR 21

Design VillaTosca

TAKÉ OPEN AIR 21, lampada da parete per esterni ideale per l'illuminazione di porticati e terrazzi. Finitura testa di moro anodizzata, diffusore realizzato in PE bianco opale. È dotata di attacco standard E27 che lascia libera scelta per il tipo di sorgente luminosa da utilizzare.

TAKÉ OPEN AIR 21, outdoor wall lamp, perfect to illuminate verandas and terraces. It is equipped with standard E27 socket, which allows you to choose the kind of light source you prefer. Finish: anodized dark brown, diffuser made in white opal PE.

「タケ・オープンエア-21」は屋外向けウォールタイプのランプ。アーチ回廊やテラスの理想的な照明です。塗装はダーク・ブラウンのアルマイト加工。セードは、ポリエチレン樹脂（PE）オパール・ホワイト。電球金口はE27のため、電球の種類をご自由にお選びいただけます。



Finishes

- 173 Dark brown (outdoor use)

Diffuser

PE Polyethylene opal white

Suggested light source

 E27 ECO Fluo Warm Comfort Light
max 1x23W

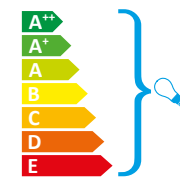

Certification

   Classe I IP54

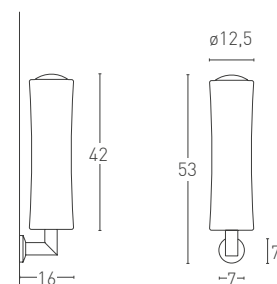

Units: cm



PROJECTS&SYSTEMS

La vocazione di LUMEN CENTER ITALIA per il "su misura" affonda le radici nel tempo ed ha creato negli anni importanti occasioni per crescere, sperimentare e per realizzare grandi progetti a livello internazionale. Attraverso i progetti custom LUMEN CENTER ITALIA ha creato nuovi prodotti, personalizzato ed adattato i propri per creare esperienze di luce che rendessero speciali quei luoghi per cui erano state pensate. La capacità di saper lavorare in maniera "sartoriale" continua a far sì che LUMEN CENTER ITALIA possa realizzare forniture speciali per progetti architettonici e contract, possa realizzare prodotti di illuminazione su disegno del cliente e installazioni artistiche.

"UN GRANDE LABORATORIO CHE PERSEGUE L'ECCELLENZA, IN CUI DESIGNER, ARCHITETTI, INGEGNERI, TECNICI E ARTIGIANI LAVORANO INSIEME"

Augusto Grillo, Presidente LCI

LUMEN CENTER ITALIA's vocation for "custom made" products has deep roots in the past and has created during the years important opportunities to grow, experiment and realize big projects worldwide. Through custom-made projects, LUMEN CENTER ITALIA has created new products, modifying and adapting its standard products to create experiences of light to make special those places they were designed for. The ability to deliver a "custom made" service allows LUMEN CENTER ITALIA to make special editions for architectural and contract suppliers of lighting systems according to the customer's design and for artistic installations.

"A GREAT LABORATORY THAT PURSUES EXCELLENCE, WHERE DESIGNERS, ARCHITECTS, ENGINEERS, TECHNICIANS AND CRAFTSMEN WORK TOGETHER"

Augusto Grillo, President LCI

ルーメンセンター・イタリアの「オーダーメイド」に対する思いは長きに亘って存在しています。数々の重要な機会の度に実験と成長を繰り返し国際レベルのプロジェクトを実現してきました。カスタマイズ化されたプロジェクトを通してルーメンセンター・イタリアは新しい製品を生み出してきました。製品が設置される空間を「光の経験」によって特別なものへするため変更、改良を行ってきました。衣服の様に「テーラー・メイド」することができる実力を備えています。このためルーメンセンター・イタリアは特別な建築・コントラクトプロジェクトの製品提供を可能にし、さらにクライアントのデザインなど芸術的な照明インストールのための製品等も実現可能にしているのです。

「偉大なる工房とは、デザイナー、設計者、技術者や職人などのエンジニアが一丸となって卓越性を追及出来る場です」

アウグスト・グリッロ LCI会長

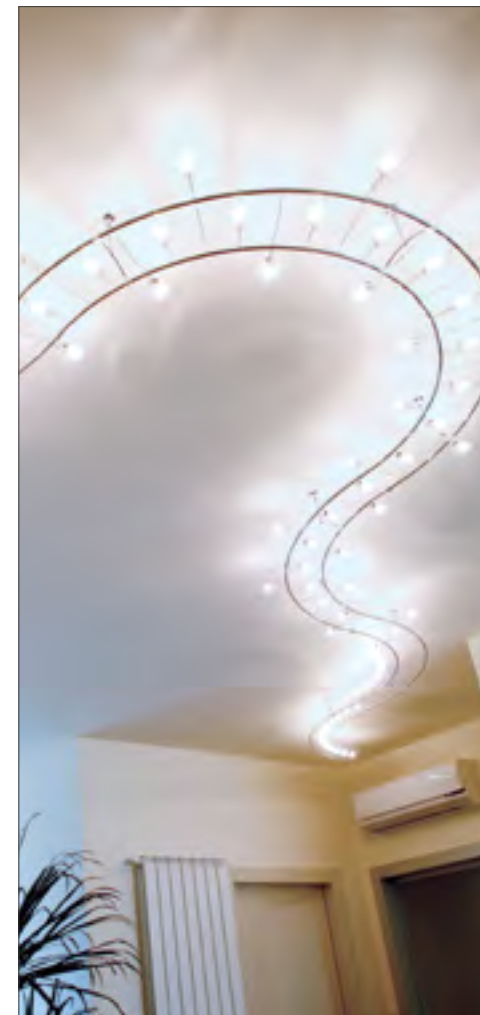

TECHNICAL INFORMATION

Tutti i prodotti LUMEN CENTER ITALIA che rientrano nell'ambito di applicazione della direttiva europea bassa tensione B.T. 73/23 e successiva modifica 93/68, soddisfano ai requisiti richiesti e recano la marcatura CE. Tutte le dimensioni sono espresse in cm. salvo se diversamente indicato nella scheda tecnica. Le istruzioni di montaggio e di manutenzione sono incluse negli imballi, così come i certificati e le condizioni di garanzia. Le indicazioni relative a materiali e finiture riguardano solo le parti principali visibili dei prodotti. Generalmente i prodotti sono forniti senza lampadina salvo se diversamente indicato nel listino prezzi. LUMEN CENTER ITALIA Srl si riserva di apportare qualsiasi modifica tecnica o formale ai prodotti a catalogo senza dovere di preavviso.

Tutti i dati relativi all'efficienza luminosa emessa dai nostri apparecchi, sono da intendersi nominali e riferiti alle specifiche tecniche delle sorgenti luminose (lampade a LED, alogene e fluorescenti) dichiarate dal costruttore. I dati di effettivo consumo ed emissione luminosa, basati sulle caratteristiche elettriche (tensioni e correnti di alimentazione, dimmerabilità ecc.), fisiche ed estetiche degli apparecchi (colore, materiale, tipologia ecc.), verranno fornite al cliente su specifica richiesta.

All LUMEN CENTER ITALIA products that are part of the scope of the European low voltage directive BT 73/23 and consecutive amendment 93/68, meet the necessary requirements and bear the CE labeling. All dimensions are in cm., unless otherwise indicated in the technical sheet. The assembly and maintenance instructions are included in the packages, as well as all certificates and warranty conditions. The indications about the materials and the finishes only refer to the main visible parts of the products. In general, the products are supplied without bulbs, unless otherwise indicated in the price list. LUMEN CENTER ITALIA Srl reserves the right to make any technical or formal modifications to the products contained in the catalogue, without any notice.













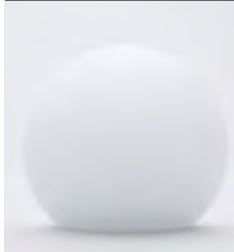



All the data related to the bright efficiency emitted by our devices, are nominal and concerning to the specific technics of our bright sources (LED, halogen and fluorescent lamps) declared by the producer. The data of effective consumption and luminous emission, based on electric characteristics (potential differences and power supplies, dimming etc.) on physic and aesthetic of the devices (colour, material, type etc.) will be provided on customers demand.

ルーメンセンター・イタリアの全ての製品はヨーロッパの低電圧適合指示「B.T.73/23」とその改正事項「93/68」に則って製造されており、その要求仕様を満たした上でCE規格を表示しています。全ての寸法はセンチメートル単位です（テクニカル・シートに特別に記載されている寸法を除く）。取扱説明書、組み立て説明等は商品に同梱されています。証明書ならびに保証書も同様です。製造素材や、塗装に関しては製品の主要部品に関してのみ指定されています。大多数の製品は、電球無しで納品しております。（プライスリストに標記されているものを除く）ルーメンセンター・イタリア Srlはカタログ内にある製品の技術的、デザイン的な変更を前向きなく行うことができる権利を保持しています。

このカタログに記載されている弊社の照明器具で使用している光源の出力データ及び消費電力などはすべて光源製造元の標準データに基づくものです。光源（LED、ハロゲン、蛍光灯、等）の技術仕様は各製造元の情報をご確認ください。照明に搭載されお客様の元に届いている弊社の商品の実際の出力及び消費電力などは、ご使用になる電気の種類（電源の電圧、電流、調光時の状態、等）、照明本体の造形上の特性（色、素材、仕様状態、等）などから、お客様のお手元に届いた商品ごとに標準データと違う場合がございます。あらかじめご了承ください。

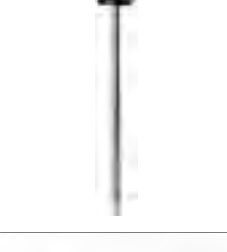
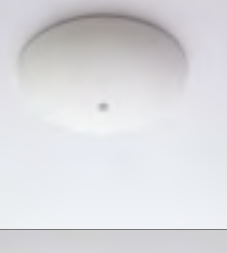
Suspension lamp	Dual-emission light	Table lamp	Product conforms to European Community Directive
Diffused light	Indirect light	Diffused light	Product Safety of Electrical Appliance & Materials certification for Japan
Direct light	Diffused indirect light	Dual-emission light	Certification for Russian Federation
Dual-emission light	Indirect light	Direct studio light	
Linear dual-emission light	Diffused light beam	Adjustable light beam studio	IP20 Protected against entry of solid objects larger than 12 mm. No protection against the ingress of water
Indirect light	Adjustable light	Outdoor lamp	IP44 Protected against entry of solid objects larger than 1 mm. Protected against water spray from all direction
Ceiling lamp	Indirect light		IP54 Protected against dust. Protected against water spray from all direction
Diffused light	Floor lamp	Suitable for mounting on normally inflammable surface	
Diffused light beam	Diffused light	Built-in driver	
Diffused light beam	Dual-emission light	Electronic driver	
Diffused indirect light	Indirect light	Classe I Class 1	
Wall lamp	Adjustable light beam	Class 2	
Diffused light	Indirect light	Class 3	

ACCESSORIES AND REPLACEMENTS

	112 114 119 120 130 131 166	Ceiling rose ø8 x 5 cm		ABS P1 Ceiling rose Japan ø9 x 12,5 cm		03 Diffuser Murano Glass HELIOPOLIS HELIOLED HELIOS 18 x 11,6 x 20 cm
	112 114 119 120 130 131 160	Double ceiling rose ø8 x 5 cm		ABS P2 Ceiling rose Japan for steel cable ø9 x 12,5 cm		Diffuser Etched Pyrex CORAL Serie ø2,6 x 9 cm
	112 114 119 120 130 131 166	Small ceiling rose ø7 x 3,5 cm		106 P3 Ceiling rose Japan adapter ø13 x 3,5 cm		Switch dimmer 100/500W 220/240V
	106 150	Ceiling rose 4/8 ø18 x 5 cm		106 P4 Adjustable ceiling rose Japan adapter ø13 x 3,5 cm		Switch dimmer 60/130W 230V
	106 150	Ceiling rose 12/16 ø22 x 5 cm		Picket outdoor TAKÉ Open air ISASS Open air ø1,5 x 40 cm		
	ABS	Ceiling rose ø12 x 3 cm		Base outdoor TAKÉ Open air ISASS Open air ø27 x 1,5 cm		
	112 114 119 120 130 131 166	Ceiling rose UL adapter ø12 x 0,6 cm		Cable outdoor 5/10 m		

COLOURS AND FINISHES

EPOXY-POWDERS LAQUERING		102 Matt black		123 Pearl grey		171 Polished Aluminium		04 Acid transparent		
		103 Fine textured (FT) Black		125 Fine textured (FT) Anthracite grey		172 Natural anodized Aluminium	TEXTILE		BC White	
		105 Fine textured (FT) White		126 Fine textured (FT) Sage green		173 Dark brown (outdoor use)			C Cognac	
		106 Matt white		127 Fine textured (FT) Senape		174 Black anodized Aluminium		R Red wine		
		112 Glossy black	GALVANIC FINISHES		150 Chrome		175 Gold polished Aluminium		W Sage	
		114 Glossy white			157 Black Nickel		176 Bronzed Brass	OTHER MATERIALS		ABS White
		115E Fine textured (FT) Dust grey		160 Palladium		177 Copper plated Brass			AL Painted die cast Aluminium	
		115D Fine textured (FT) Graphite grey	NATURAL METALS		152 Satin Brass	FOIL FINISHES		130 Gold foil		PC Self extinguishable Polycarbonate
		115R Fine textured (FT) Sand grey			153 Polished Brass			131 Silver foil		P Satin Pyrex glass
		116 Fine textured (FT) Emerald		155 Polished Inox		132 Copper foil		PE Polyethylene		
	117 Fine textured (FT) Oxyde	WOOD		163 Copper		LN Walnut		PMMA Methacrylate		
	119 Chartreuse green			165 Satin Inox		LR Oak		PMMAD Methacrylate Diffuser		
	120 Red		166 Satin Nickel		LRN Black Oak		RA Acrylic resin			
	121 Sandblasted Aluminium		168 Natural polished Aluminium	GLASSES		03 Murano Glass Acid opal white		ZB Zinc		

CREDITS

ART DIRECTION

Alessandro Zamperetti
Francesca Grillo

PHOTOS

Barbara Bonomelli
Gianni Comunale
Fernando Guerra / FG+SG
Simona Monfrinotti
Paolo Pandullo
Francesco Radino

PHOTO EDITING

Simona Monfrinotti
Marco Zani

GRAPHIC DESIGN

Simona Monfrinotti

TRANSLATION

Takahiro Aoyama
Eva Cantaro
Cinzia Carnevale
Fabiola Grillo
Simona Secchi
Masaaki Yanagisawa

CONTENT DEVELOPMENT

Francesca Grillo
Alessandro Zamperetti

TECHNICAL DEVELOPMENT

Mario Carcano
Daniele Gianella
Lorenzo Zecchin
Masaaki Yanagisawa

PRINT

Reda Print Srl

ASSOCIATION

ASSOLOMBARDA
www.assolombarda.it
ASSOLUCE
www.federlegnoarredo.it
ECOLIGHT
www.ecolight.it
LANDBELL
www.landbell.de



ASSOLUCE



LIGHTING SPONSOR



SPECIAL THANKS

LUMEN CENTER ITALIA Srl thanks in particular Casa Linea & Vierwändewerk, Wuppertal (Germany) / Michael and Ulriche Albermann / Casa Taíde, Rui Viera Oliveira and Vasco Manuel Fernandez architects - Lahnoso (Portugal) / House of Denmark / De Padova Srl / Il Loft Spa / Casa Cantoni / Casa Cesar Sergio / Casa Pruner / Composit Srl / Novamobili Spa.

Thanks to all the collaborators who have daily supported and worked at the new company relaunch.

Questa pubblicazione sostituisce ed aggiorna i precedenti cataloghi con riferimento ai prodotti elencati in questa pubblicazione.

This publication replaces and updates the previous catalogues with reference to the products contained in this publication.

このカタログに記載されているデータは、これまで出版されたカタログのものから変更されている場合がございます

II edizione Novembre 2016
Second edition November 2016

LUMEN CENTER ITALIA Srl
Via Donatori del Sangue n.37
20010 Santo Stefano Ticino (MI) Italia
tel. +39 02 3654 4811
info@lumencenteritalia.com

ITALY OFFICE
tel. +39 02 3654 4311
italysales@lumencenteritalia.com

EXPORT OFFICE
tel. +39 02 3654 4308
exportsales@lumencenteritalia.com



lumencenteritalia.com
LIGHT CREATIVITY INNOVATION

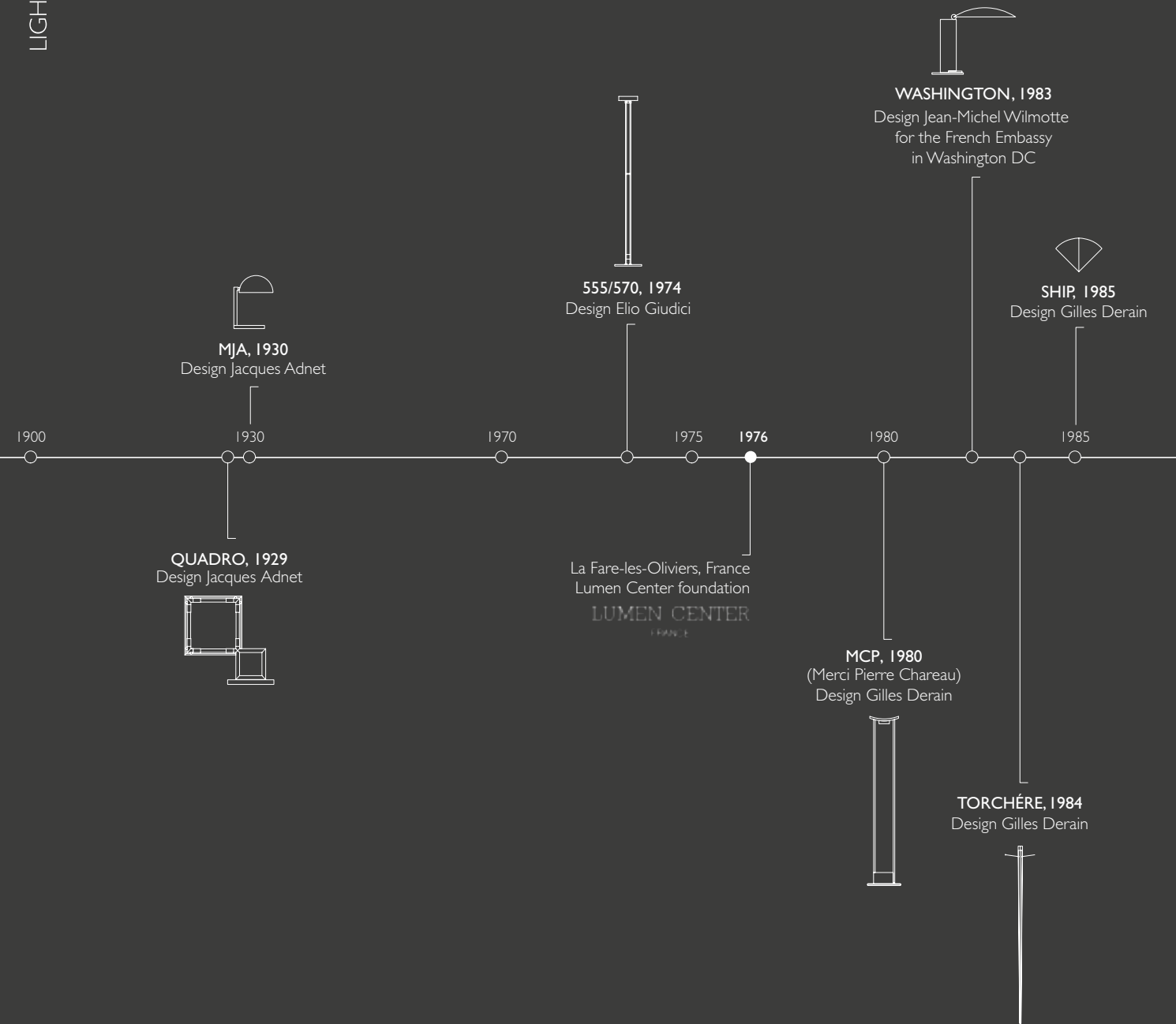

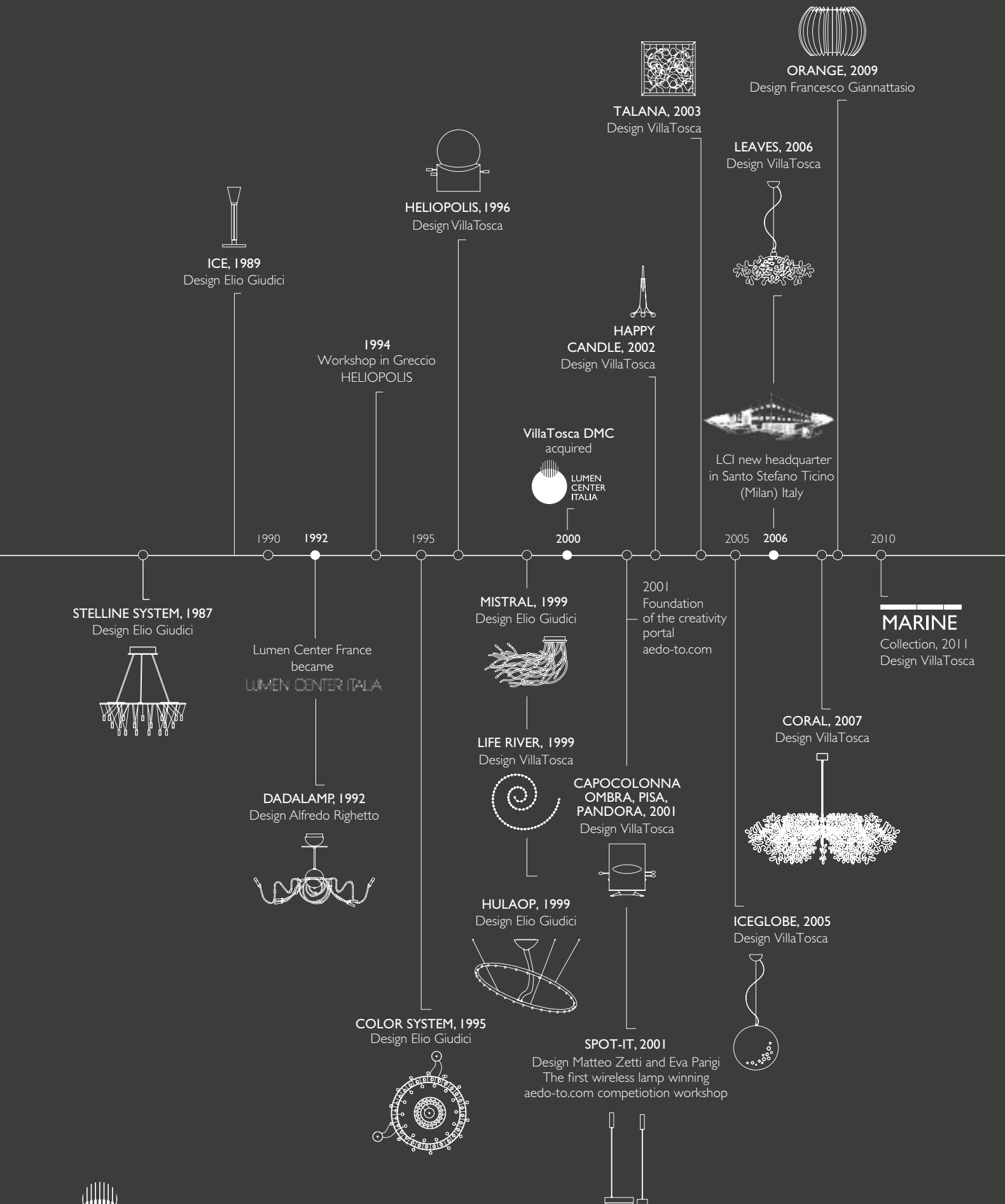

ICE, 1989
Design Elio Giudici

HELIOPOLIS, 1996
Design VillaTosca

TALANA, 2003
Design VillaTosca

ORANGE, 2009
Design Francesco Giannattasio

LEAVES, 2006
Design VillaTosca

HAPPY CANDLE, 2002
Design VillaTosca

1994
Workshop in Greccio
HELIOPOLIS

VillaTosca DMC
acquired



LCI new headquarter
in Santo Stefano Ticino
(Milan) Italy

1990

1992

1995

2000

2005

2006

2010

STELLINE SYSTEM, 1987
Design Elio Giudici

Lumen Center France
became
LUMEN CENTER ITALIA

MISTRAL, 1999
Design Elio Giudici

2001
Foundation
of the creativity
portal
aedo-to.com

MARINE
Collection, 2011
Design VillaTosca

DADALAMP, 1992
Design Alfredo Righetto

LIFE RIVER, 1999
Design VillaTosca

**CAPOCOLONNA
OMBRA, PISA,
PANDORA, 2001**
Design VillaTosca

CORAL, 2007
Design VillaTosca



HULAOP, 1999
Design Elio Giudici

ICEGLOBE, 2005
Design VillaTosca

COLOR SYSTEM, 1995
Design Elio Giudici

SPOT-IT, 2001
Design Matteo Zetti and Eva Parigi
The first wireless lamp winning
aedo-to.com competition workshop



LCI | LCI
ITALIA | JAPAN

lumencenteritalia.com
LIGHT CREATIVITY INNOVATION